

Futaba CGY760R is receiver, 3-axis heading combining AVCS gyro and head speed governor in one box. Its cutting-edge MEMS (Micro Electro Mechanical System) sensor design, ultra high-speed processing speed and advanced PID control algorithm put it a quantum leap ahead of all other heading hold gyros in size, weight and performance. The CGY760R has been optimized to work for flybarless helicopters.

Flybarless Control Gyro
CGY760R

Gyro Program Box

GPB-1

INSTRUCTION MANUAL

-
- No part of this manual may be reproduced in any form without prior permission.
 - The contents of this manual are subject to change without prior notice.
 - This manual has been carefully written. Please write to Futaba if you feel that any corrections or clarifications should be made.
 - Futaba is not responsible for the use of this product.

Compliance Information Statement (for U.S.A.)

This device, trade name Futaba Corporation, model number CGY760R, complies with part 15 of the FCC Rules. Operation is subject to the following two conditions:

- (1) This device may not cause harmful interference, and
- (2) This device must accept any interference received, including interference that may cause undesired operation.

CAUTION: To assure continued FCC compliance

1. Any changes or modifications not expressly approved by the grantee of this device could void the user's authority to operate the equipment.
2. This equipment complies with FCC radiation exposure limits set forth for an uncontrolled environment.

This equipment should be installed and operated with minimum distance 20cm between the radiator & your body.

The responsible party of this device compliance is:

Futaba Service Center

3002 N Apollo Drive Suite 1, Champaign, IL 61822 U.S.A.

TEL (217)398-8970 or E-mail: support@futaba-rc.com (Support)

Compliance Information Statement (for Canada)

This device complies with Industry Canada license-exempt RSS standard(s). Operation is subject to the following two conditions: (1) this device may not cause interference, and (2) this device must accept any interference, including interference that may cause undesired operation of the device. This equipment complies with IC radiation exposure limits set forth for an uncontrolled environment. This equipment should be installed and operated with minimum distance 20cm between the radiator & your body.

French: Cet appareil radio est conforme au CNR-210 d'Industrie Canada. L'utilisation de ce dispositif est autorisée seulement aux deux conditions suivantes : (1) il ne doit pas produire de brouillage, et (2) l'utilisateur du dispositif doit être prêt à accepter tout brouillage radioélectrique reçu, même si ce brouillage est susceptible de compromettre le fonctionnement du dispositif. Cet équipement est conforme aux limites d'exposition aux rayonnements IC établies pour un environnement non contrôlé.

Cet équipement est conforme aux limites d'exposition aux rayonnements IC établies pour un environnement non contrôlé. Cet équipement doit être installé et utilisé avec un minimum de 20 cm de distance entre la source de rayonnement et votre corps.

Declaration of Conformity (for EU)

Hereby, Futaba Corporation declares that the radio equipment type is CGY760R in compliance with Directive 2014/53/EU. The full text of the EU declaration of conformity is available at the following internet address:

<http://www.rc.futaba.co.jp/english/dl/declarations.html>

TABLE OF CONTENTS

• Introduction	2
• Warranty and Repair Service (in U.S.A.)	5
• Features	6
• Contents	8
• Replacement and Optional Items	10
• Precautions	11
• Mounting / Part name / Connecting	17
Mounting the CGY760R	18
Link Method With Transmitter (FASSTest / T-FHSS)	21
Connecting The CGY760R	22
Governor Installation	24
• First Map	28
• Home Screen	30
• GBP-1 Menu	33
• Basic Menu	39
• S.BUS Basic Menu (S.BUS Basic Setting)	40
• SWH. Basic Menu (Swash Basic Setting)	44
Installation And Setting Of Swash Servo	53
• FLT. Tune Menu (Flight Tuning Setting)	57
• RUD. Basic Menu (Rudder Gyro Basic Setting)	62
• GOV. Basic Menu (Governor Basic Setting)	66
Governor Speed Setting	73
Governor Operation	73
• Recommended Gyro Gain Setting	73
• Adjustments During The Test Flight	73
• Tips Using The Governor With Electric Models	76
• TX Aileron/Elevator Gyro Gain Set-up	77
• Expert Menu (Setup Style: 3D)	78
• RUD. Expert Menu (Rudder Gyro Expert Setting)	79
• FLT. Expert Menu (Cyclic Gyro Expert Setting)	83
• SWH. Detail Menu (Swash Detail Setting)	86
• GOV. Expert Menu (Governor Expert Setting)	93
• Expert Menu (Setup Style: F3C)	78
• AIL. Expert Menu (Aileron Gyro Expert Setting)	98
• ELE. Expert Menu (Elevator Gyro Expert Setting)	101
• F3C Spatial Expert Section	103

• Specifications	3
------------------	---

 : Instructions for gyro functions

 : Instructions for governor functions

Technical updates and additional programming examples can be found at:

www.futaba-rc.com/faq

WARRANTY & REPAIR SERVICE (IN U.S.A.)

If any difficulties are encountered while setting up or operating your CGY760R, please consult the instruction manual first. For further assistance you may also refer to your hobby dealer or contact the Futaba Service Center at the web site, fax or telephone number listed below:

www.futaba-rc.com or www.hobbyservices.com

Fax (217)-398-7721, Tel (217) 398-0007

If you are unable to resolve the issue, pack the system in its original container with a note enclosed and a thorough, accurate description of the difficulty. Include the following in your note:

- Symptoms (including when the problem occurred)
- System (Transmitter, Receiver, Servos and model numbers)
- Model (Model name)
- Model numbers and quantity
- Your Name, Address and Telephone number

Send the respective items to the authorized Futaba Service Center Address below:

Futaba Service Center
3002 N Apollo Drive Suite 1
Champaign, IL 61822

- Combined Receiver, 3-Axis Gyro and Governor in one box.
- High speed operation and extremely low latencies result in greater stability.
- Low profile, small size and light weight.
- Using gyro and governor program setting device GPB-1.
- Settings divided into Basic and Expert menus. The basic setting is for initial setting and Expert setting is for more advanced settings.
- Firmware can be updated from a Windows based personal computer when used with the optional CIU-2 or iCIU-3 nterface.
- S.BUS 2 compatible.

• Gyro section

- Advanced and adaptive PID control loop is utilized.
- Simultaneous control of 3 axes (roll, pitch, yaw).

Rudder (yaw) section:

- Capable of sensing angular velocity up to +/- 1,000 deg/sec.
- Compatible with 1520 μ S Analog (70Hz), 1520 μ S Digital (280Hz), and 760 μ S Digital (560Hz) tail rotor servos.
- Feed Forward Option allows the CGY760R to consider other control functions during operation. This results in more accurate corrections and precise operation.
- Cutting edge control algorithm provides a consistent pirouette rate, precise operation, and smooth yaw control in any flight condition.

Aileron, Elevator (roll, pitch) section:

- Developed specifically for flybarless helicopters.
- Supports H3-120, H3-140, H3-90, H4-00, and H4-45 swash plate types.

• Governor section

- Advanced and adaptive PID control loop is utilized.
- High speed operation and extremely low latencies provide a more consistent and accurate operation.
- Capable of governing head speeds from 700 RPM through 4000 RPM
- Compatible with 1520 μ S Analog (70Hz) and 1520 μ S Digital (280Hz) throttle servo types.
- Feed Forward Option allows the CGY760R to consider other control functions

- during operation. This results in precise governing of the head speed.
- Governor or Revolution Limiter mode selectable.
- Supports gear ratios from 1.00 through 50.00.
- Cutting edge control algorithm provides more consistent RPM governing.
- Revolution sensor is compatible with the GV-1. The CGY760R also supports a optional back plate revolution sensor and brushless phase sensor.

• Receiver section

- Switch FASSTest - 2.4 GHz system and T-FHSS - 2.4 GHz system using the Gyro Program Box GPB-1 system.
- By S.BUS 2 system compatibility, it is possible to transmit the battery voltage information of the receiver and the optional sensor information connected to the S.BUS 2 port of the receiver.
- Diversity antenna system.

• Other functions

- Maximum RPM memory.
- Cumulative engine operation timer.
- Integration function of engine operation time.

Your CGY760R includes the following components:

Type of set

- CGY760R / GBP-1 / Governor set
- CGY760R / GBP-1 set
- CGY760R
- GBP-1

SET CONTENTS	CGY760R / GBP-1 / Governor set	CGY760R / GBP-1 set	CGY760R	GBP-1
GBP-1 Program Box				
*CGY760R connection code	X	---	X	X
*Transmitter connection code				
*Velcro tape (for attaching to transmitter)				
CGY760R				
*Mounting Pads (x3)	---	X	X	X
*Dust Covers (x3)				
Governor Sensor				
*Sensor Mounting Bracket	---	---	---	X
*Magnet (x2)				
Instruction Manual	X	X	X	X
Decal	X	X	X	X

X: supplied ---: not supplied

GBP-1 Gyro Program Box

When setting up the gyro and the governor, connect it to the CGY760R and use it. Will not install it on a helicopter.



CGY760R



Mounting Pads (3)

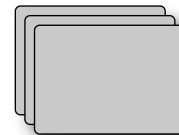

Revolution Sensor



Sensor Mounting Bracket

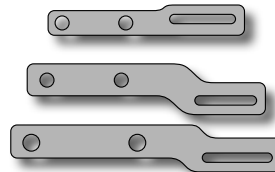

Magnets (2)



CGY760R Connection Code

It is used to connect the CGY760R and the Gyro Program Box GPB-1.



Transmitter Connection Code

Connect the transmitter to the Gyro Program Box GPB-1 and use the transmitter to transfer the settings of GPB-1 to the CGY760R wirelessly.



Dust Cover (3)



REPLACEMENT & OPTIONAL ITEMS

Futaba PC Interface CIU-2 / CIU-3

Governor Revolution Sensor Set

Mounting Pad (10)

Sensor Mounting Bracket Set

Backplate Sensor BPS-1

PRECAUTIONS

Meaning of Special Markings

Pay special attention to safety where indicated by the following marks:

⚠ DANGER - Procedures which may lead to dangerous conditions and cause death/serious injury if not carried out properly.

⚠ WARNING - Procedures which may lead to a dangerous condition or cause death or serious injury to the user if not carried out properly or procedures where the probability of superficial injury or physical damage is high.

⚠ CAUTION - Procedures where the possibility of serious injury to the user is small, but there is a danger of injury, or physical damage, if not carried out properly.

⊘ : Prohibited ⓘ : Mandatory

⚠ WARNING

Failure to follow these safety precautions may result in severe injury to yourself and others.

- Read through the entire manual before operating this product.

USAGE PRECAUTION:

* When using FASSTest 12 CH mode, analog servo can not be used for 1-6 CH output for conventional system.

* The FASSTest system is not compatible with the conventional FASST system.

⚠ CAUTION

⊘ **Do not mount GPB-1 (Gyro Program Box) on the helicopter.**

* It will be damaged by vibration.

ANTENNA INSTALLATION PRECAUTION:

⚠ WARNING

ⓘ **Be sure that the two antennas are placed at 90 degrees to each other.**

*The CGY760R has two antennas. In order to maximize signal reception and promote safe modeling Futaba has adopted a diversity antenna system. This allows the receiver to obtain RF signals on both antennas and fly problem-free.

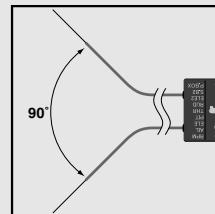

- ⊘ Do not cut or bundle the receiver antenna wire.
- ⊘ Do not bend the coaxial cable. It causes damage.
- ⊘ Do not bend the base of the antenna or drop it from the base side of the antenna onto the ground and do not give a shock. It causes damage.
- ⓘ Keep the antenna as far away from the motor, ESC and other noise sources as you possibly can.

CARBON FUSELAGE PRECAUTION:

⚠ WARNING

- ⓘ You must leave 30mm at the tip of the antenna fully exposed. The exposed antenna should be secured so that it cannot move around or back inside of your aircraft.



CONNECTOR INSERTION PRECAUTION:

⚠ WARNING

- ⊘ Do not connect the connector by mistake as shown on the right.

BEFORE EACH FLIGHT:

⚠ WARNING

- ⓘ Keep away from conductive materials to avoid short circuits.
- ⓘ If it does not operate properly during operation test before use or use, stop using it.
- ⓘ Always check the transmitter and receiver battery voltage to ensure they have enough remaining capacity to complete the flight.
- ⓘ Confirm that the CGY760R is operating in the correct mode.

ABOUT BATTERIES:

⚠ WARNING

- ⓘ Newer high end servos and other radio equipment are capable of

placing large demands on the power systems in use today. When using a regulator you must ensure that the regulator is capable of supplying the current demands of the equipment you have selected. In addition to this make sure the wiring and switch you have selected are capable of handling high current draws.

*The servo current draw can be up to 50% higher on a flybarless helicopter. Always ensure your receiver battery is fully charged before each flight.

ABOUT CONNECTOR:

- ⓘ Insert the connector such as sensor, servo, connection cord, battery etc. surely.

*If it is not securely inserted all the way in, it may come off due to vibration during flight and there is a danger of falling.

ABOUT WIRING:

- ⓘ Please fix at the appropriate position so that the continuing cord rub against the corner of the metal or carbon frame and the covering will not break.

ABOUT VIBRATION ISOLATION AND WATERPREEFING:

- ⓘ The CGY760R is fixed with a dedicated mounting pad with good condition and the helicopter performs sufficient anti-vibration measures so as not to receive strong vibration at the time of flight. Also, if there is a risk of watering, place it in a plastic bag and take waterproof measures.

ON FLIGHT PRECAUTION:

- ⓘ Always exit programming mode before attempting to fly the model.

Gyro operating precautions: Gyro

- ⊘ The CGY760R requires 5-10 seconds to initialize when the power is turned on. Do not move the helicopter and do not move the tail rotor, aileron and elevator sticks during this initialization or the gyro may not initialize properly. Once the initialization process has been completed the swash servos and tail servo will move several times indicating that the CGY760R is now ready for flight.

❗ Verify that the gyros are operating and compensating in the correct direction before each flight. If the compensation direction is incorrect on any axis the model will become uncontrollable after takeoff.

❗ The servo type parameters within the CGY760R must match the type of servo you are using. Incorrect setting may damage the CGY760R or the servos, possibly resulting in a loss of control during flight.

❗ Always allow the gyro to adjust to the surrounding environmental temperature before flight. A large temperature change during use will cause drift and other operational issues.

❗ If you are switching between Normal Mode and AVCS Mode in flight, please keep in mind that you must have the gyro re-learn the center position after making a trim change within the transmitter. To memorize the new center position simply flip the gain switch on the transmitter three times between Normal Mode and AVCS Mode (Normal → AVCS → Normal → AVCS) within one second. The servo will center indicating that the new center position has been memorized.

❗ When operating the gyro in AVCS Mode, all compensation and revolution mixing must be disabled and any tail rotor or swash offsets for flight modes must be disabled.

❗ Do not drop the CGY760R onto a hard surface or subject the CGY760R sensor to a strong shock as this may damage the sensor.

❗ Verify that the gyro is operating in the desired mode.

❗ When the CGY760R is operated in AVCS mode the tail rotor or swash plate servos will not center when tail rotor, aileron or rudder stick is released. This is normal operation for AVCS mode. The servos may also move to the extent while the model is being carried out to the flight line. Before take off, you must visually center the tail rotor pitch slider and level the swash plate by using the transmitter control sticks. You can also center the servos by moving the tail rotor stick full left, then full right, back to full left and then allow the stick to center within one second; the same method applies for aileron and elevator servos.

⊘ Never turn off the CGY760R while the GX (gyro) LED is blinking green at high speed (about 5 / sec).

*If you turn off the power while high-speed blinking, setting changes can not be saved and data errors may occur.

.Governor operating precautions: **Governor**

❗ When the throttle servo is connected to the CGY760R, the battery failsafe function within the CGY760R must be setup and enabled.

❗ Throttle fail safe function (transmitter setting): Use the fail safe function for the channel that turns the governor on and off to set the fail safe position to the point at which the governor is turned off. With this setting, when the system enters the fail safe state, the governor will be turned off, and the receiver throttle signal (fail safe position preset) will be output directly.

❗ When using the condition hold function on the transmitter, always set the throttle servo maximum operating point to less than the point at which the governor is activated. If this is not done the governor may activate while in condition hold.

❗ While preparing for flight or starting the engine, always ensure the throttle remains below the governor activation point and do not select any flight modes that may activate the governor.

❗ If you prefer to activate the governor while the model is still on the ground, always ensure that you have at least -5 degrees of pitch in the model before activating the governor. This negative pitch is necessary to prevent an unexpected lift off as the governor activates and the head speed increases to the desired RPM.

❗ Be sure to set the autorotation to the OFF side with the governor ON / OFF switch function.

❗ Periodically check the RPM sensor output to ensure proper governor operation. Due to the high level of vibration and centrifugal forces the magnet may come loose or the sensor alignment may change. Ev-

ery 10th flight verify that the magnet and sensor are properly mounted.

❗ If abnormality such as vibration etc. is recognized on the aircraft side during operation, be prepared to turn off the governor immediately.

MACHINE MAINTENANCE:

⚠️ WARNING

❗ Even though the CGY760R is a high performance gyro and governor, it will be necessary to ensure that the helicopter mechanics are also in optimum operating condition. Please use the guidelines below and address all issues before installing and flying the CGY760R.

- The CGY760R must be used with a rigid tail rotor drive system. Any modern torque tube or belt drive system should be adequate. Do not attempt to fly the CGY760R using a wire driven tail rotor system.

- Always ensure the drive gears, torque tube, pulleys, belt, bearings and shafts are in proper working condition. If any of these items are damaged or worn they must be replaced.

- The linkage rod, tail rotor bell crank, pitch slider and tail rotor grips must operate without friction to obtain the best performance from the CGY760R. Binding in the tail rotor control linkage will decrease the performance of the CGY760R gyro and this may also shorten the servo lifespan. Please take the time now to ensure the tail rotor system on your helicopter is working correctly and without friction or binding.

- Vibration will affect the CGY760R's overall performance. All rotating components on the helicopter should be balanced to minimize vibrations in flight. Ensure that your engine or electric motor is running smoothly and that all vibrations have been addressed before installing and test flying the CGY760R

MOUNTING / PART NAMES / CONNECTING

Mount on a model using the attached mounting pad and mount it at the center position of model gyro mount so that it is exactly orthogonal to the roll and pitch axis of the aircraft.

*The CGY760R should be mounted on a rigid platform, at least 6in [152mm] away from a Nitro Engine. It is not necessary to mount the gyro near the main shaft of the model but it is very important that the mounting area chosen is rigid. Please refer to your model manufacturer's instructions for recommended mounting locations.

Test fit the gyro sensor, ensuring that the sensor is in alignment with the model on the roll and pitch axis. The cable from the gyro sensor must exit toward the front or the rear of the model since this is the pitch axis. Any misalignment will cause a loss of performance.

Mounting angle

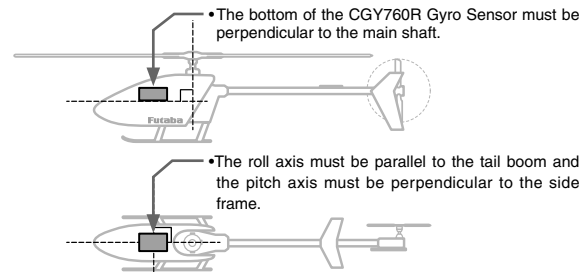

Control axis

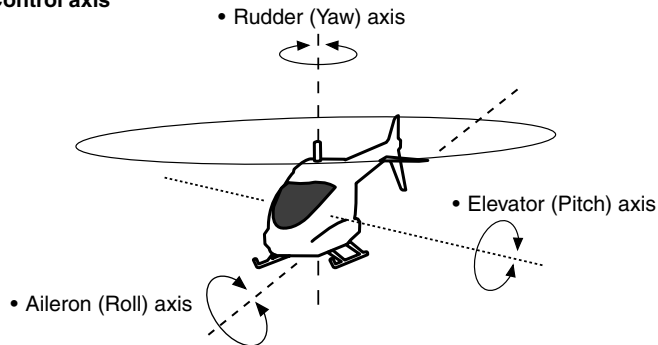

Mounting The CGY760R

The CGY760R can be mounted in the orientation shown below unless it is installed so that the roll and pitch detection axis are aligned with the model. However, if there is a deviation of 1/2 or more of the degree, performance will degrade. In this step, please pay special attention to ensure optimum flight performance. Refer to the installation example below and select the gyro mounting direction with "Gyro Set Dir" (page 45) of the SWH basic menu.

*The surface with the "CGY" mark in the figure is the top (LED) side of the CGY760R.

Gyro Set Dir---1

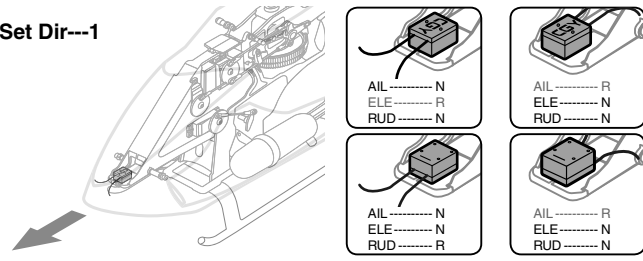

Gyro Set Dir---2

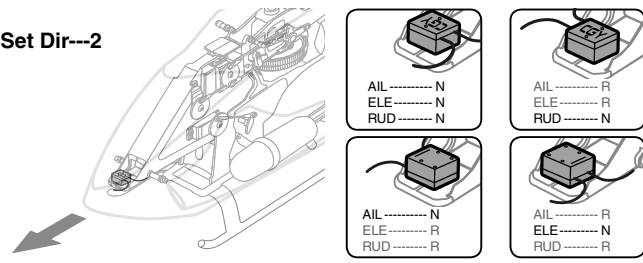

Gyro Set Dir---3

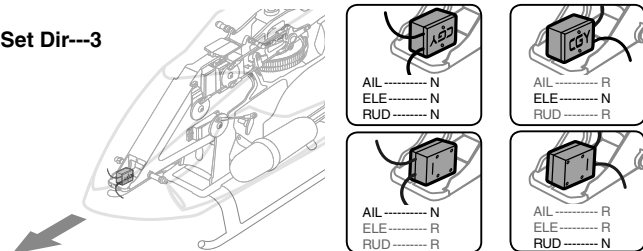

Gyro Set Dir---4

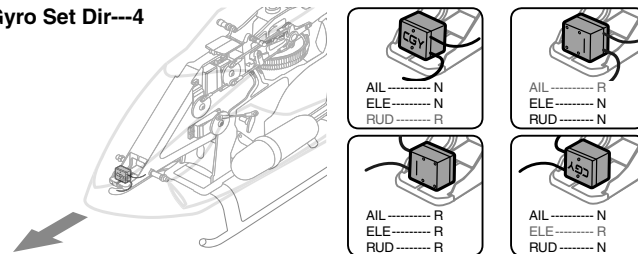

Gyro Set Dir---5

*Depending on the type of mounting plate, it is also possible to mount as shown in the figure.

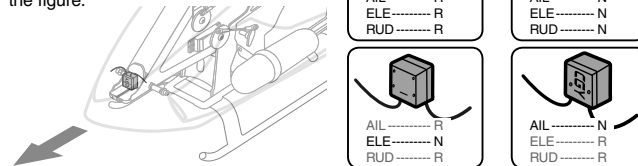

Gyro Set Dir---6

*Depending on the type of mounting plate, it is also possible to mount as shown in the figure.

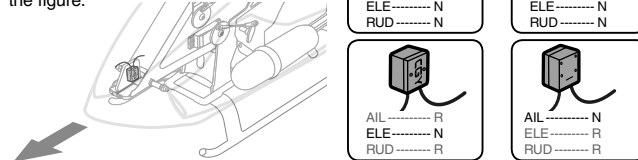

It is necessary to set the motion direction of each gyro by "AGy.Dir", "EGy.Dir" of "SWH. BASIC" menu (page 49) and "Gyro.Dir" of "RUD BASIC" menu (page 63).

AIL-Aileron (Roll) axis / ELE-Elevator (Pitch) axis / RUD-Rudder (Yaw) axis
N --- Normal / R --- Revers

*Please fix the cord connected to the main body with a margin.

Please install the CGY760R as it is in the center (vertical direction and horizontal direction) of the tape without cutting the attached mount pad. This tape is designed to effectively absorb the vibration from the model.

*Clean the oil on the bottom of the CGY760R and the machine mounting part with a vacuum cleaner or the like.

*The CGY760R is designed to be screwed to the gyro mount. Please refer to the end of this manual for fixing method of screws and notes on installation.

The CGY760R Cant Be Mounted TROUBLESHOOTING

If any issues are noted during flight (such as drifting, inconsistent hold or inconsistent control rates) then please review the following troubleshooting recommendations.

1. Always verify that the tail rotor and swash plate mechanisms operate, and that the drive system is in proper working order.
2. Electromagnetic interference could be causing the problem. If you feel everything is set up correctly and that the model is vibration free, then consider moving the gyro sensor to a new location away from servos, ESC and drive motors.
3. Vibrations will decrease the performance of all gyro systems. Even though the CGY760R gyro sensor is the most vibration resistant gyro sensor available, eliminating vibrations will always improve performance. The CGY760R gyro sensor performs best when the sensor is mounted rigidly to the airframe. This is mainly due to the sensing of all 3 axes. It is highly recommended to avoid using soft foam pads as this may allow the gyro to bounce around on the roll and pitch axis, causing instabilities and possible loss of control during flight so that the roll and pitch sensing axis are in alignment with the model. Any misalignments over 1/2 of a degree will cause a loss in performance. Please take extra care in this step to ensure the optimum flight performance.

Using The CGY760R With A Electric Model

⚠ DANGER

⚠ It is necessary to remove the pinion gear from the electric motor or disconnect the motor from the ESC before powering the model up for setup or bench testing. Electric motors are extremely powerful and capable of delivering the power instantly, causing injury to yourself, others, or the surroundings.

Once the ESC is connected to the CGY760R, you need to complete all necessary transmitter settings (ATV / EPA / REV / ETC) according to ESC instructions. Please refer to page 109 of this manual for further suggestions on the use of the governor of CGY760R and the electric model.

Link Method With Transmitter (FASSTest / T-FHSS)

1. Connect the CGY760R and GPB-1 and set the same mode as the transmitter linking the CGY760R communication mode on the "Receiver" screen. (See page 40)
 2. Keep the transmitter and receiver close to each other and turn on the receiver with the transmitter in the link mode.
 3. Wait for link waiting about 2 seconds after turning on receiver power.
 4. If the RX LED changes from red flashing to green lighting, the link is complete. (The link wait state ends in about 1 second.)
- * Refer to the transmitters operation manual for complete details on how to place the transmitter into the linking mode.
- * When many FASSTest systems are turned on near the FASSTest system or when many T-FHSS systems are turned on near the T-FHSS system, the CGY760R establishes a link to the transmitter It may be difficult. This is rare. However, if another FASSTest transmitter / receiver is linked at the same time, the CGY760R may link to the wrong transmitter. If you do not notice such a situation, this is very dangerous. To avoid this problem, we strongly recommend that you reconfirm if the CGY760R is actually controlled by the transmitter.
- * If the System Type of the transmitter is changed, the receiver will need to be re-linked to the transmitter.

⚠ WARNING

⚠ Do not perform the linking procedure while the motor's main wire connected or the engine is operating as it may result in serious injury.

⚠ When the linking is complete, please cycle the receiver power and ensure the receiver is properly linked to the transmitter.

⚠ Please power up your system in this order. Transmitter first, followed by the receiver.

⚠ If the CGY760R was previously linked to another transmitter, make sure that transmitter is not operating while linking the receiver to the new transmitter.

Connecting The CGY760R

GX (Gyro) LED

LED	State
Lights red	During normal operation
Blinking green	Normal blinking (about 2 / sec): S.BUS data wait time High-speed blinking (about 5 / sec): Backing up data ⊙Never shut down during backup
Blinking red	Error such as abnormality of gyro sensor If you can not recover by turning the power back on or replacing the battery, please contact our customer service.



RX (Receiver) LED

LED	State
Lights green	During normal operation
Lights red	No signal reception
Red and Green turn on alternately	Unrecoverable failure (EEPROM, etc.) If you can not recover by turning the power back on please contact our customer service.

(9) P.BOX:

- Connect to CGY760R when making settings. When setting is completed remove it.



LCD

- Displays menus, parameters.

Edit key

- Used to set operating parameters.

(10) Transmitter Connection Code:

- Connect when using the transmitter to wirelessly transfer settings of GPB-1 to CGY760R.

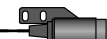

(1) RPM (Revolution sensor):

- Connect the revolution sensor.

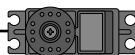

(2) AIL Output:

- Connect the aileron (roll) servo.

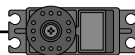

(3) ELE Output:

- Connect the elevator (pitch) servo.



(4) PIT Output:

- Connect the pitch (collective pitch) servo.



(5) THR Output:

- Connect the throttle servo.
- Connect the ESC w/BEC and set the operation mode to Gyro+THR mode.

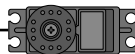

(6) RUD Output:

- Connect the rudder (yaw) servo.



(7) ELE2 Output:

- Connect the second elevator servo. (Swash mode: H4-XX)

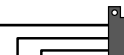

(8) S.B2 Output:

- Connect the S.BUS2 tool.

Terminal box

Connect the receiver battery (3.5 to 8.4 V) to one of the "AIL" to "S.B2" connectors other than "RPM" and "P.BOX".

(Do not connect to "RPM" and "P.BOX".)

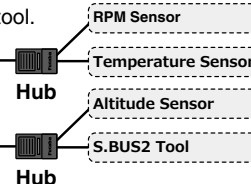

*This diagram shows the various connections between the CGY760R and receiver, servo, or sensors.

*S.BUS2 is a system that supports bidirectional communication from a telemetry sensor to a receiver by extending the conventional S.BUS. Telemetry sensor etc are connected to S.BUS2 connector and used. S.BUS compatible servo etc can not be used with S.BUS 2 connector terminal.

S.BUS Channel Setting

The default CGY760R S.BUS channel assignments should work properly with most Futaba transmitters. If you experience any problems please refer to the S.BUS section of the manual to set / verify each channel number for each function.

1. The SBUS basic menu (page 44) of CGY760R is displayed.
2. Use the [▲/+] or [▼/-] key to select "AIL CH #" and press the [Enter] key to enter setting mode. Check the transmitter's aileron channel and set it to match the channel with the [▲ /+] or [▼/-] key. When you are done, press [Enter] key to exit setting mode.
3. Perform the same operation as above and set the function (such as aileron, pitch, collective, gain, ail gain, ele gain, rpm, gv on/off) channels to the transmitter.
4. If your transmitter does not offer enough channels to operate all of the CGY760R's functions, it is possible to operate the CGY760R without the Gov SW, Ail Gain, and Ele Gain channels connected. When any these functions are not used, it is necessary to set the channel number to "INH" within the CGY760R's S.BUS menu to disable the function and to use the setting value inside the CGY760R menu instead. When the Gov SW channel is not used, the governor on/off control is handled by the [Stick Switch] function.

Governor Installation

Modify the cooling fan and install the accessory magnet and attach the magnetic sensor to the engine at the position shown below. Balance the cooling fan as needed following magnet installation.

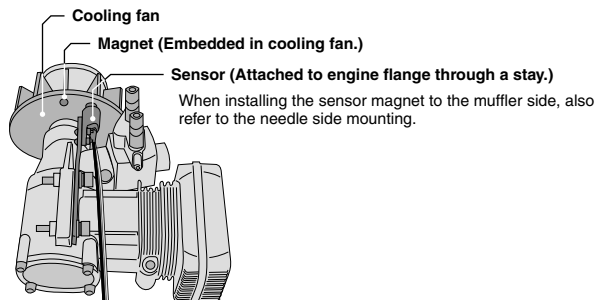

❑ Magnet Operating Side Check

Bring the magnet near the end of the sensor and check the operating side.

*This is the side at which the displayed value increases in the "Revolution sensor testing" menu within the "Governor Basic Setting" section earlier in this manual. Install the magnet with this side facing the sensor. Mark this side of the magnet with a felt tip pen.

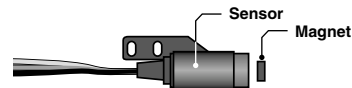

❑ Cooling Fan Modification

1. Drill a hole in the fan at the magnet mounting position. Make the hole about 4.1mm in diameter and 1.5 to 1.7mm deep.
2. Embed the magnet in this hole in the direction in which an output is obtained. Use epoxy adhesive that cures in 30 minutes or longer. Do not use epoxies that contain metal such as JB Weld.

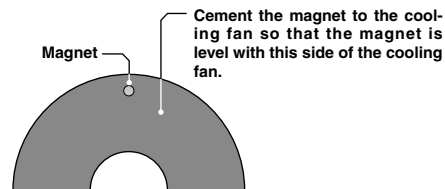

3. If the cooling fan is unbalanced and vibrates, etc., balance it by mounting the spare magnet to the opposite side of the cooling fan in the opposite polarity (so that it does not output a signal).

❑ Sensor Mounting

The sensor mounting method depends on the model and engine.

1. Mount the sensor to the sensor stay. (Temporary assembly)
2. Drill a hole in the fan cover at the part corresponding to the sensor so that the distance between the sensor and magnet can be made 1 to 2mm.

3. Tighten the sensor stay together with the engine mounting flange. (Temporary assembly)
4. Select the mounting method so that the sensor does not touch the frame, or other parts of the model. Temporarily mount the sensor and select the magnet mounting position.
5. Install the sensor to the sensor stay using the accessory screws and washers.
6. Tighten the sensor stay together with the engine using the engine mount screw.

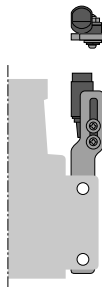

□ Sensor Adjustment

1. Adjust the sensor position to obtain a sensor output of at least 60% in the "Revolution sensor testing" menu within the "Governor Basic Setting" .

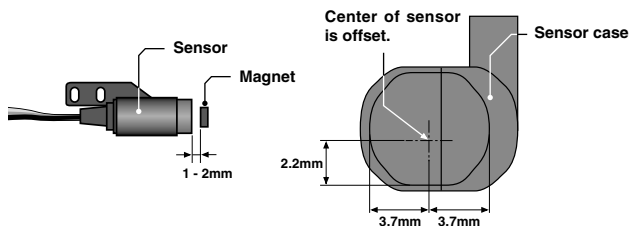

2. The center of the sensor is different from the center of the sensor case so be careful when mounting the sensor.
If the display is less than 60% when the magnet is directly below the sensor, bring the sensor closer to the magnet so that the 60% or more is displayed. The magnet and sensor gap criteria is approximately 1 to 2mm. If a sensor output is not obtained even when the sensor is brought close to the magnet, the magnet and sensor center positions may have changed.
3. Complete assembly of the sensor by securely tightening the screws that were temporarily tightened.
4. Recheck the sensor output.

□ Throttle Servo Linkage Precautions

- To effectively use the governor, observe the following precautions when connecting the servo linkage.
- Make the servo operating range as wide as possible. Make the throw of the transmitter EPA (ATV) function and AFR function as close as possible to 100%.
- Fly with the governor turned OFF and adjust the needle so that the engine smoothly reacts to movement of the transmitter stick.
- If there is a point at which the reaction of the engine is considerably different due to a too rich or too lean mixture, the governor may not operate to its maximum potential.

□ Fuselage Vibration Countermeasures

If the model frame is weak, or the engine mount is deformed or not installed properly, the vibrations applied by the engine will increase. Engine vibrations will lead to unstable speed and prevent the governor from providing maximum performance. Therefore, make sure that the engine is vibration free and that the carburetor provides linear throttle control because the governor cannot correct engine problems.

□ Use Of A Tuned Silencer

The use of a tuned pipe type silencer may cause the engine throttle response to be substantially different from that of a normal muffler. Adjust the needle (and pipe length) so that engine speed changes are proportional to the throttle opening. The governor will not perform satisfactorily with a muffler or a pipe that does not allow the carburetion to be linear.

Connect GPB-1 (Gyro Program Box) And CGY760R

Set GPB-1 display setting, CGY760R reception system setting, gyro and governor settings.

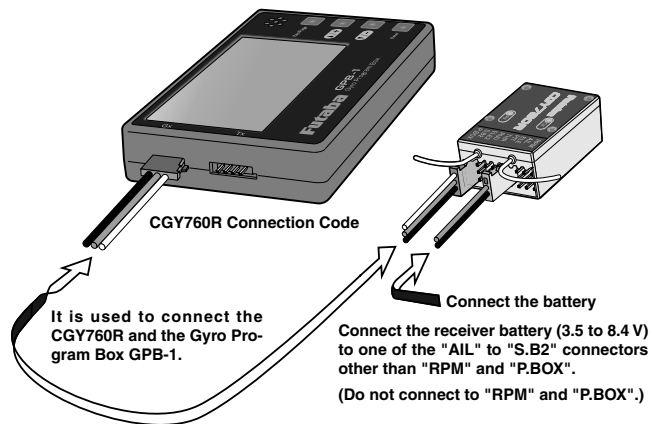

CAUTION

⚠ Be sure to connect and disconnect the CGY760R and GPB-1 connection cord with the power off.

Opening Screen And Home Screen

When GPB-1 starts up with power on, the opening screen is displayed first, then the home screen is displayed.

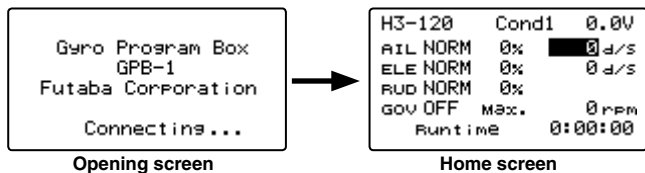

Each menu screen is displayed from the home screen.

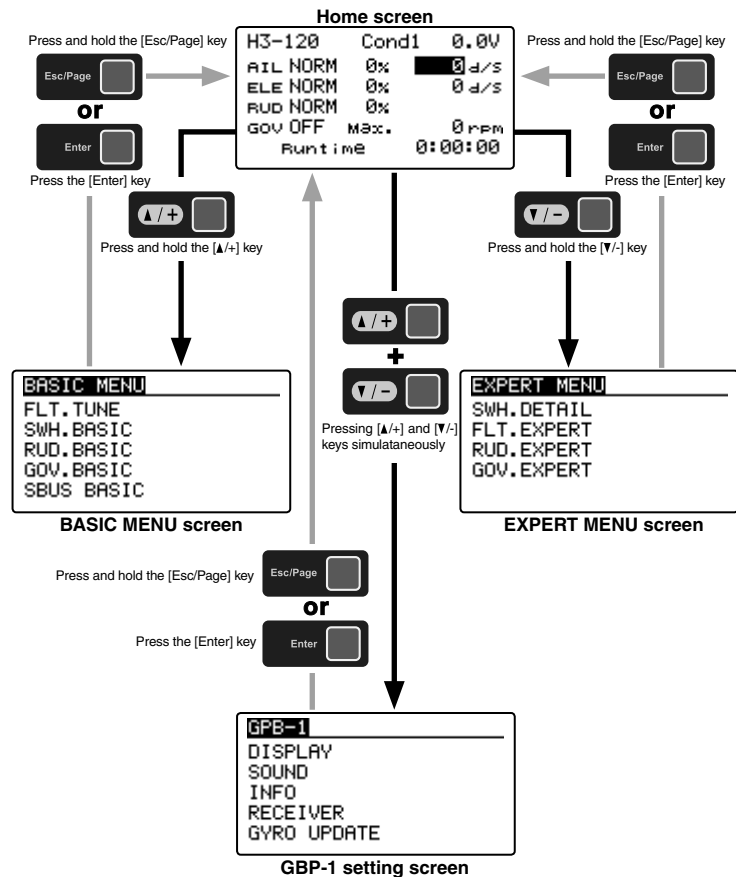

HOME SCREEN

Home Screen Display

On the home screen, basic information such as swash type, gyro operation mode, sensitivity and governor ON / OFF, engine operating time etc. are displayed.

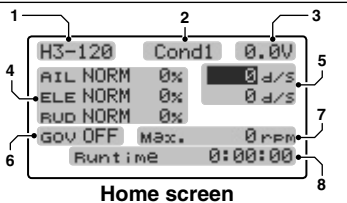

1. Swash plate type

Displays the swash plate type set in "SWH. BASIC" menu.

2. Condition number

With switch operation from the transmitter, several parameters can be switched by setting up to 5 types of data. If you set the condition switch to the channel having the AFR function of the transmitter and set the point for each flight condition with the AFR point curve, it can also be linked with the flight condition switch.

•When set to SW of DG 1 or DG 2, it becomes as follows.

Function Menu of your transmitter (DG1). Assigning DG1 to a switch or flight mode allows the use of two separate values for the condition selectable parameters.

For functions that can set conditions in this manual, mark **Cond** is written.

Cond1 (Condition 1)

- SWS.Rate ● Cnt.AuthAl ● HeadHid E ● GOV.Gain
- PIT.Rate ● Cnt.AuthEL ● StpTune A ● Lmt.Hov
- SWS.Ring ● EXPO ● StpTune E ● L.Lmt.IdUp
- FLT.Styl ● HeadHid A ● CYC.Rt

Cond2 (Condition 2)

- SWS.Rate ● Cnt.AuthAl ● HeadHid E ● GOV.Gain
- PIT.Rate ● Cnt.AuthEL ● StpTune A ● L.Lmt.Hov
- SWS.Ring ● EXPO ● StpTune E ● L.Lmt.IdUp
- FLT.Styl ● HeadHid A ● CYC.Rt

*Indicates when the setup style is "3D".

Switch Channel Rate

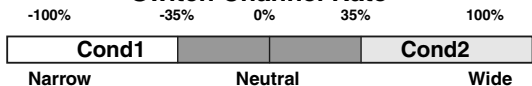

•If you set a condition switch channel to an empty channel that can set the AFR function and set a point curve for each flight condition of the transmitter, it becomes as follows.

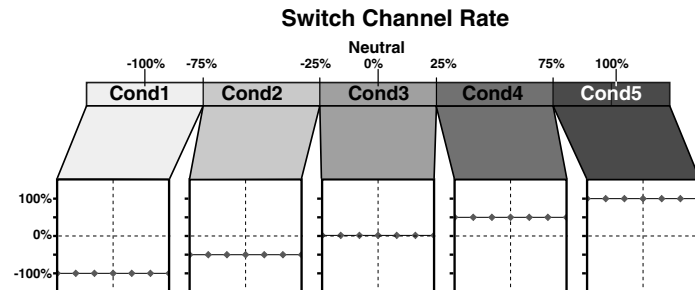

Set the point curve with AFR for each flight condition of the transmitter.

3. Battery voltage

Displays the voltage of the receiver battery connected to CGY760R.

4. Gyro operation mode / Gyro gain

Displays "AVCS" or "Normal" operation mode and setting sensitivity of aileron (roll), elevator (pitch) and ladder (yaw) axis.

5. Roll and Elevator rate maximum display

This screen displays the maximum roll rate and maximum elevator rate recorded during flight. Data is reset when the power is turned off. If you want to check the maximum rate, leave the power on after flight. Use the [▲/+] or [▼/-] key to move the cursor to each rate display and press and hold [Enter] key to reset the display.

6. Governor ON / OFF

Indicates the ON / OFF switch status of the governor function. When "ON" is displayed, the governor function is activated.

7. RPM display

The maximum revolutions of the engine memorized by the governor during operation is displayed. Data is reset when the power is turned off. If you want to check the maximum speed, leave the power on after flight. Use the [▲/+] or [▼/-] key to move the cursor to the rotation number display and press and hold [Enter] key to reset the display.

8. Engine running time

Displays the running time of the engine. Up to 9,999 hours are displayed.

Use the [▲/+] or [▼/-] key to move the cursor to the operation time display and press and hold [Enter] key to reset the display. The operation time is stored in memory even when the power is turned off until it is reset.

Data saving screen

After setting change the following screen will be displayed when saving data.

(Display is short time)

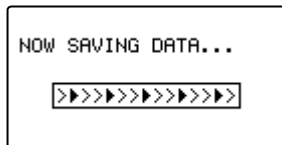

How to operate each menu screen

Use the [▲/+] or [▼/-] key to move the cursor to the setting item on the screen and press the [Enter] key to enter the setting mode. [▲/+] or [▼/-] key to change the setting contents. When you are done, press [Enter] key to exit setting mode.



GPB-1 MENU

It is a menu for setting GPB-1 display etc.

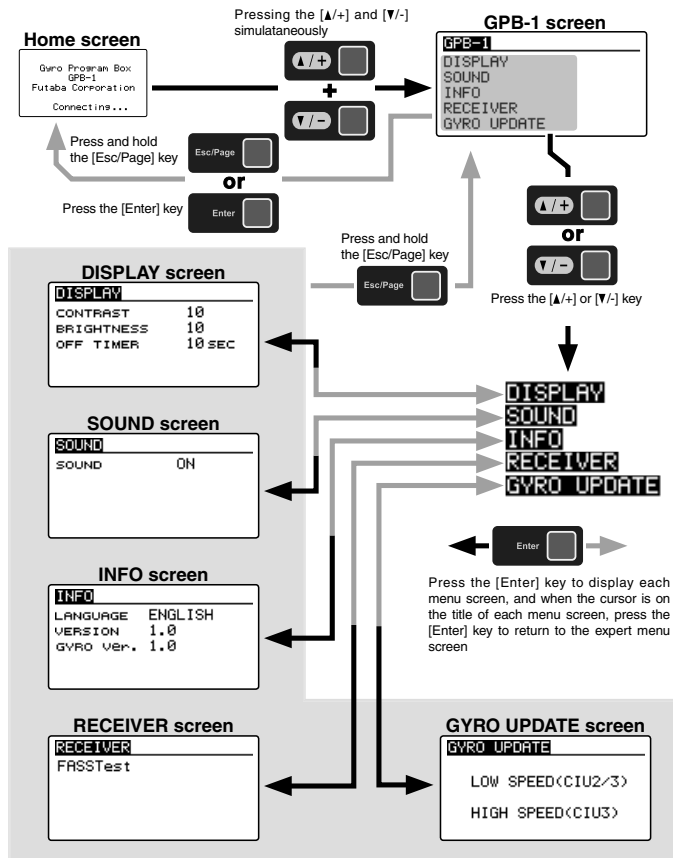

DISPLAY (display setting of GPB-1)

Set the contrast and brightness of the screen of the GPB-1 and the lighting time of the backlight. Refer to page 37 to display the "DISPLAY" screen from the GPB-1 menu screen.

DISPLAY screen

DISPLAY
CONTRAST 10
BRIGHTNESS 10
OFF TIMER 10 SEC

CONTRAST 10

BRIGHTNESS 10

OFF TIMER 10 SEC

(1) CONTRAST CONTRAST 10

Move the cursor to "CONTRAST" with the [▲/+] or [▼/-] key and press the [Enter] key to enter the setting mode. Adjust the contrast with the [▲/+] and [▼/-] keys. When you finish adjusting, press [Enter] key to exit setting mode.

Setting ranges: 0 ~ 20 Initial value: 10

(1) BRIGHTNESS BRIGHTNESS 10

Move the cursor to "BRIGHTNESS" with the [▲/+] or [▼/-] key and press the [Enter] key to enter the setting mode. Adjust the brightness with the [▲/+] and [▼/-] keys. When you finish adjusting, press [Enter] key to exit setting mode.

Setting ranges: OFF (Backlight off) / 0 ~ 20 Initial value: 10

(1) OFF TIMER OFF TIMER 10 SEC

Adjust the time until the backlight turns off after the last key operation. Move the cursor to "OFF TIMER" with the [▲/+] or [▼/-] key and press the [Enter] key to enter the setting mode. Use the [▲/+] and [▼/-] keys to adjust the lighting time of the backlight. When you finish adjusting, press [Enter] key to exit setting mode.

Setting ranges: OFF (Always on) / 0 ~ 240 sec Initial value: 10 sec

SOUND (Key operation sound of GPB-1)

It is ON/OFF setting of key operation sound of GPB-1. Refer to page 37 to display the "SOUND" screen from the GPB-1 menu screen.

SOUND screen

SOUND ON

SOUND ON

(1) SOUND SOUND ON

Set ON / OFF of key operation sound of GPB-1. Move the cursor to "SOUND" with the [▲/+] or [▼/-] key and press the [Enter] key to enter the setting mode. Select the ON or OFF of key operation sound with the [▲/+] or [▼/-] key. When you finish setting, press [Enter] key to exit setting mode.

Setting: ON / OFF Initial setting: ON

INFO (Display language and version of GPB-1)

Displays the GPB-1 display language setting, program version and gyro version. Refer to P37 and display the information screen from the GPB-1 menu screen.

INFO screen

INFO
LANGUAGE ENGLISH
VERSION 1.0
GYRO ver. 1.0

LANGUAGE ENGLISH

(1) LANGUAGE LANGUAGE ENGLISH

Set the display language of GPB-1. Move the cursor to "LANGUAGE" with the [▲/+] or [▼/-] key and press the [Enter] key to enter the setting mode. Select the display language with the [▲/+] or [▼/-] key. When you finish setting, press [Enter] key to exit setting mode.

Setting: ENGLISH / JAPANESE / GERMAN

RECEIVER (Receiver system setting)

On the "RECEIVER" screen, set the CGY760R receiver system to the same mode as the transmitter to use. Refer to page 37 and display the "RECEIVER" screen from the GPB-1 menu screen.

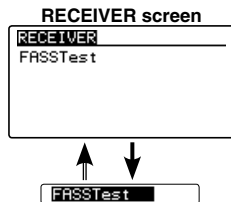

(1) RECEIVER FASSTest

Set the same system as the transmitter to be linked. Move the cursor to the system such as "FASSTest" with the [▲/+] or [▼/-] key and press the [Enter] key to enter the setting mode. Then select the system with the [▲/+] or [▼/-] key. Since "EXECUTE: Enter (1sec)" is displayed. Pressing the [Enter] key for about 1 second changes the selected system and exits the setting mode.

Setting: FASSTest- / T-FHSS

NOTE:

To change the "Receiver System" type, first power off the TX and RX, and re-power the CGY760R while the TX is still in the OFF position. The only way to change the RX type is by power cycling the gyro first.

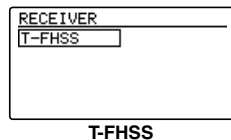
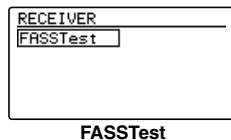

GYRO UPDATE (Update mode of CGY760R)

It is a menu to set the update mode to update CGY760R from PC using CIU-2 or CIU-3.

- * The following optional products are required for the update.
 - CIU-2 or CIU-3
 - Code for CGY760R / GY701 / GY520 or DSC code for update

(1) Download CGY760R update file

Download the CGY760R update file from our website or your local distributor's website.

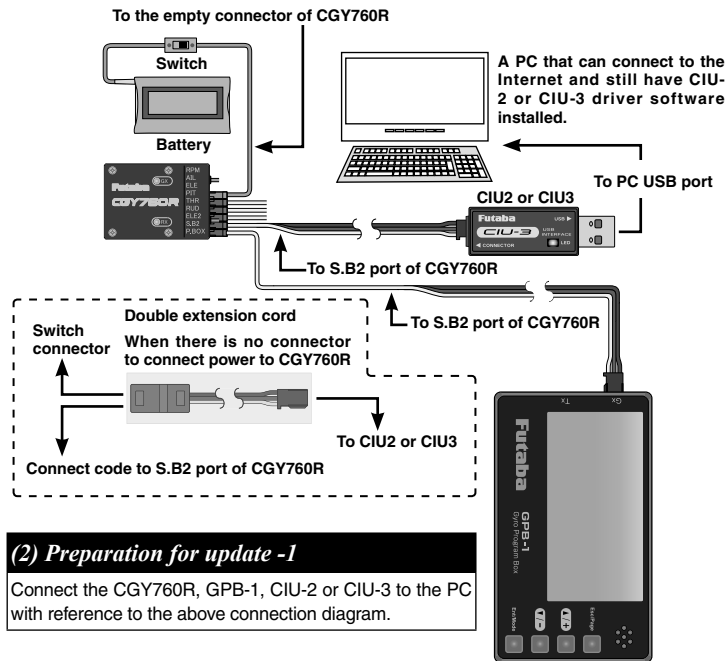

(2) Preparation for update -1

Connect the CGY760R, GPB-1, CIU-2 or CIU-3 to the PC with reference to the above connection diagram.

GYRO UPDATE screen

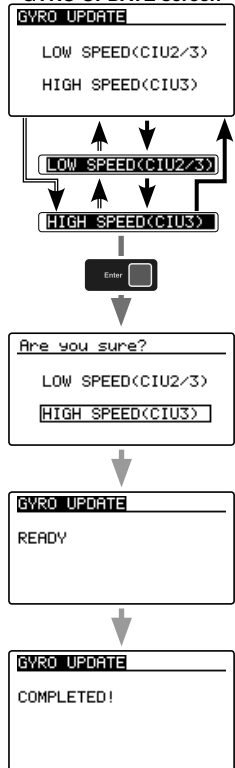

(3) Preparation for update -2

Refer to page 37 and display the "GYRO UPDATE" screen from the GPB-1 menu screen.

(4) Selection of CIU (Speed)

Use the [▲/+] or [▼/-] key to move the cursor to "LOW SPEED (CIU2/3)" or "HIGH SPEED CIU3" and press the [Enter] key. It shows. When ready, "READY" will be displayed.

(5) Perform update

Click on the update file downloaded to the PC to update the CGY760R.

(6) Update complete

When the update is successfully completed, "Completed" appears on the screen of GPB-1.

If the update is not performed normally, "Shippai Shimashita" will be displayed. In that case please try again from the beginning. If it fails again please download the update file again.

BASIC MENU

It is a menu which makes basic setting of CGY760R. Make sure to set each basic menu.

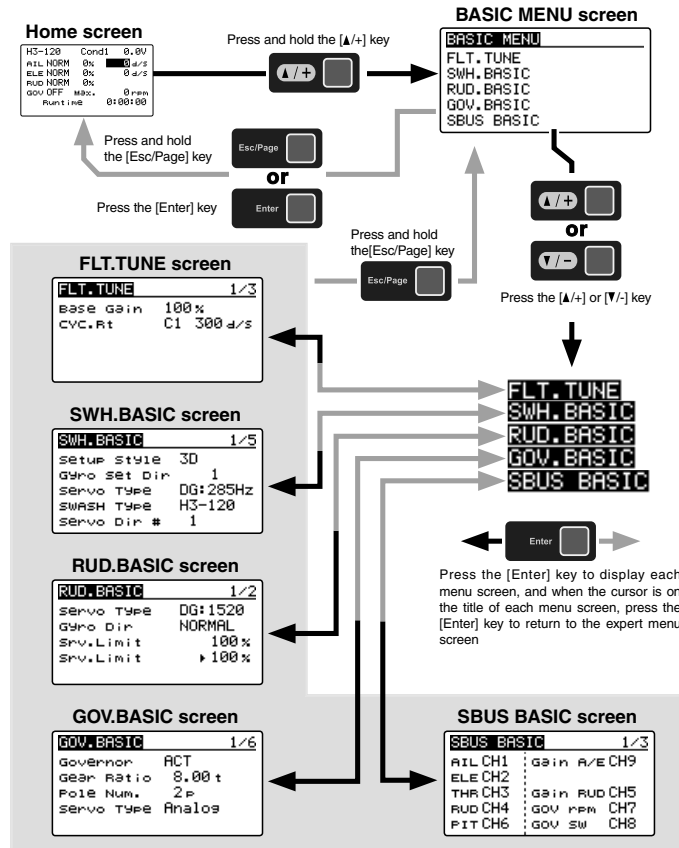

Press the [Enter] key to display each menu screen, and when the cursor is on the title of each menu screen, press the [Enter] key to return to the expert menu screen

SBUS BASIC MENU (S.BUS BASIC SETTING)

The SBUS basic screen is displayed from the basic menu screen (see page 39). Set the CH for each function according to the transmitter to be used. Set unused functions to [INH]. If a function is not going to be used, then it must be set to [INH]. If a function is not going to be used, then it must be set to [INH]. For example, if the Gain A/E and Gain RUD remote gain functions are not going to be used, then set them to [INH] and the CGY760R will then allow you to make gain adjustments within the respective menu.

From 3/3 >>> From the "RESET" of SBUS BASIC screen 3/3

SBUS BASIC screen 1/3

SBUS BASIC 1/3	
AIL CH1	Gain A/E CH9
ELE CH2	
THR CH3	Gain RUD CH5
RUD CH4	GOV rpm CH7
PIT CH6	GOV SW CH8

Go to 2/3 from any cursor position

[▲/+] : =>

[▼/-] : =>

[Esc/Pop] : >>>

Settings (all in common):
1 to 16ch, DG1, DG2, INH

AIL CH1

ELE CH2

THR CH3

RUD CH4

PIT CH6

WARNING

Always verify that the S.BUS function assignments match your transmitter's function (in the FUNCTION menu) assignments. If any changes are made within the transmitter function assignments, then it will also be necessary to make the changes within the S.BUS function assignments.

(1) S. BUS connection: AIL (Aileron) channel AIL CH1

Move the cursor to "AIL CH #" by pressing the [▲/+] or [▼/-] key and press the [Enter] key to enter the setting mode. Use the [▲/+] or [▼/-] key to set the aileron channel of the transmitter. When you are done, press [Enter] key to finish.

(2) S. BUS connection: ELE (Elevator) channel ELE CH2

Using the [▲/+] or [▼/-] key to set the correct channel number.

(3) S. BUS connection: THR (Throttle) channel THR CH3

Using the [▲/+] or [▼/-] key to set the correct channel number.

(4) S. BUS connection: RUD (Rudder) channel RUD CH4

Using the [▲/+] or [▼/-] key to set the correct channel number.

(5) S. BUS connection: PIT (Pitch) channel PIT CH6

Using the [▲/+] or [▼/-] key to set the correct channel number.

From 1/3 >>>

SBUS BASIC screen 2/3

SBUS BASIC 2/3	
Cond	-100 0 +10
Cond2	>

Cond DG1

(6) S. BUS connection: Gain A/E channel Gain A/E CH9

Using the [▲/+] or [▼/-] key to set the correct channel number.

Gain AIL CH9

F3C

Gain ELE CH10

If the "Setup Style" setting of the "SWH BASIC" menu on page 49 is "F3C", set the aileron (Roll) gain and the elevator (Pitch) gain on separate channels. (Gain AIL and Gain ELE display)

(7) S. BUS connection: Gain RUD channel Gain RUD CH5

Using the [▲/+] or [▼/-] key to set the correct channel number.

(8) S. BUS connection: GOV rpm channel GOV rpm CH7

Using the [▲/+] or [▼/-] key to set the correct channel number.

(9) S. BUS connection: GOV sw channel GOV SW CH8

Using the [▲/+] or [▼/-] key to set the correct channel number.

(10) S. BUS connection: Condition on change channel Cond DG1

Select "Cond CH #" in the same way and use the [▲/+] or [▼/-] key to set the condition change channel of the transmitter.

As with the flight condition function of the transmitter, you can set up and use up to five data of several parameters by switch operation from the transmitter. By setting the condition switch on the channel with the AFR function of the transmitter and setting the point for each flight condition with the AFR point curve, you can switch the condition of CGY760R in conjunction with the flight condition switch of the transmitter.

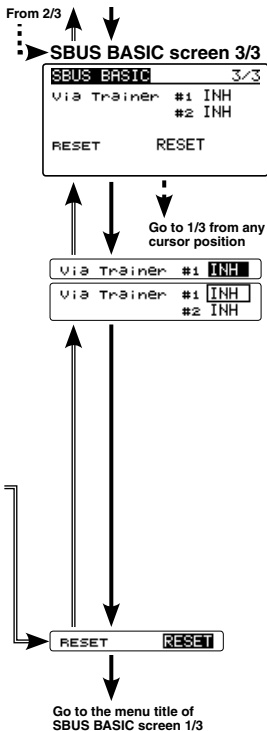

(11) S. BUS connection: Via trainer channel

Via Trainer #1 INH

Select "Cond #" in the same way and use the [▲/+] or [▼/-] key to set the via trainer channel of the transmitter.

The transmitter's trainer channel uses two consecutive channels. For example, if CH11 is set to "# 1", CH12 is automatically set to "# 2". Therefore, when using this function, two consecutive free channels are required for the transmitter.

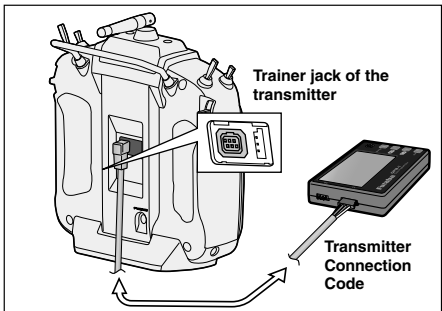

CAUTION

❗ Be sure to connect and disconnect the transmitter and GPB-1 connection cord with the power off.

(12) RESET: S.BUS data reset

RESET RESET

This resets the S.BUS channel assignments back to the defaults. Move the cursor to "RESET" by pressing the [▲/+] or [▼/-] key, and press the [Enter] key to enter the reset mode. Since "EXECUTE: Enter (1sec)" is displayed, press and hold the [Enter] key for about 1 second to initialize S.BUS channel setting. If you do not reset, press [Enter] key or [Esc/Page] key to exit reset mode.

About Transfer Function Of Gyro Setting Data

With this function, by connecting the transmitter and the GPB-1 with the transmitter connection cord, it is possible to wirelessly change the setting of the CGY 760R mounted on the model via the transmitter. For the list of functions that can be changed, refer to pages 106 to 107. Before connecting the GPB-1 to the transmitter, please connect to the CGY 760R and save the original data to GPB-1.

Setting on transmitter side

- Follow the transmitter's instruction manual, use the channel function function to connect two consecutive AUX 2.
- Set the two free channels to the following settings.
 - Sub Trim: ----- 0
 - Fail safe: ----- hold
 - Battery fail safe: ----- OFF
 - Set the end point: ----- 100
 - The limit point: ----- 155 (maximum)
 - Servo speed: ----- 0
 - Servo Reverse: ----- Normal
- Set the trainer function as follows according to the transmitter's instruction manual.
 - Always ON
 - Teacher / Student: ----- Teacher
 - Channel mode: ----- 16CH
 - Mode: ----- Normal
 - Rate: ----- 100

After connecting the GPB-1 to the TX via trainer port, power on the TX. Upon turning the TX "On" the GPB-1 will show the opening screen and the ID screen will be displayed. The ID number should be the same as the ID sticker on the CGY760R. If the ID numbers match, press and hold the [Esc / Page] key to display the trainer via function setting screen. **Note:** If the ID is different on the ID confirmation screen, connect CGY760R and GPB-1 that you set once and save the data of CGY760R to GPB-1.

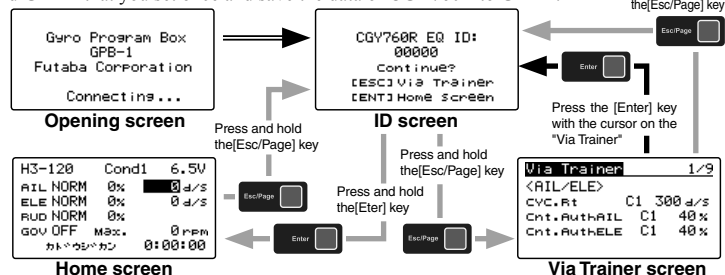

SWH. BASIC MENU (SWASH BASIC SETTING)

Perform basic setting of swash motion. When using the aileron, elevator gyro, be sure to make this swash basic setting. Refer to page 39 to display the "SWH. BASIC" screen from the "BASIC MENU" screen.

The CGY760R corresponds to the following six types of swash plate.

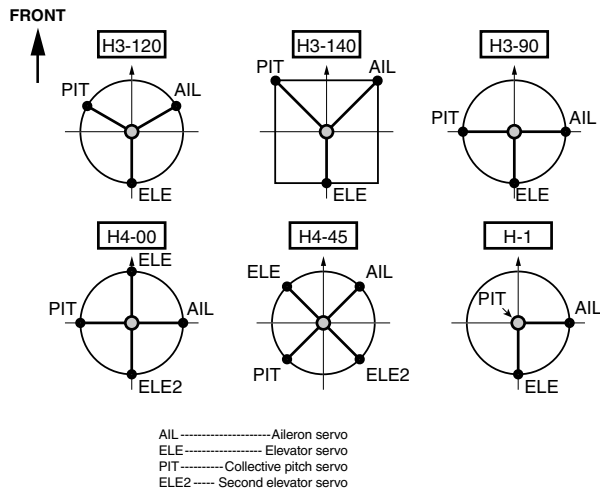

Your transmitter should be reset to the default settings and the swash plate type selected with the transmitter should be set to "H-1" or single servo mode. All CCPM mixing is set up and handled with the CGY760R, and the transmitter functions should not be used. Before starting model set-up, be sure that all dual rates, pitch curve, and endpoint values are set to 100/100.

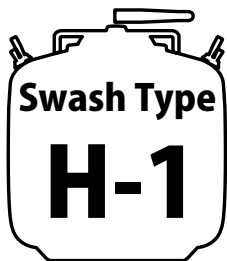

⚠ WARNING

⚠ Do not connect the servo to the gyros until you select the servo type in the swash basic menu.

*If the servo type is wrong, CGY760R or servo malfunction may result.

From 5/5... From the "Pit.Low" of SWH. BASIC screen 5/5

SWH. BASIC screen 1/5

```
SWH.BASIC 1/5
Setup style 3D
Gyro Set Dir 1
Servo Type DG:285Hz
SWASH Type H3-120
Servo Dir # 1
```

Go to 2/5 from any cursor position

Setup style 3D

(1) Setup style Setup style 3D

3D mode contains a proven set of parameters which are good for not only 3D but also F3C flying. F3C Mode is for Advanced F3C tuning only.
*The changed menu is indicated on a map.
*When the style is changed, setting of AIL/ELE/RUD is initialized.
Move the cursor to "Setup style" by pressing the [▲/+] or [▼/-] key and press the [Enter] key to enter the setting mode. Use the [▲/+] or [▼/-] key to set the style. Since "EXECUTE: Enter (1sec)" is displayed. Pressing the [Enter] key for about 1 second changes the selected style and exits the setting mode.

Gyro Set Dir 1

(2) Gyro Set Dir: Mounting direction Gyro set Dir 1

Set the roll axis, pitch axis, yaw axis according to the mounting direction of CGY 760R. Set mounting direction with reference to page 18 - 19.
Move the cursor to "Gyro Set Dir" by pressing the [▲/+] or [▼/-] key and press the [Enter] key to enter the mounting direction. Then select the mounting direction # with the [▲/+] or [▼/-] key. When you finish setting, press [Enter] key to exit setting mode. When the LED on the Gx side finishes blinking, please turn the power off and on again to confirm that it is working properly.

Setting: 1 ~ 6 Initial setting: 1

⚠ WARNING

If you do not turn the power back on after changing "Gyro Set Dir", the gyro-scope will not operate properly, there is a danger of crashing.

Servo Type DG:285Hz

(3) Servo Type

Servo Type DG:285Hz

This selects the swash servo types. There are four kinds of the servo driving frequency selection, AN:70Hz, DG:95Hz, DG:140Hz, DG285Hz. Previous version supported Analog= AN: 70Hz and DG:1520= DG:285Hz only. All Futaba digital servos can be operated with fastest DG:285Hz mode but some of other brands servos do not support DG:285Hz mode. In this case, select the proper servo driving frequency per the manufacturer's specifications. Move the cursor to "Servo Type" by pressing the [▲/+] or [▼/-] key and press the [Enter] key to enter the setting mode. Then select the servo type with the [▲/+] or [▼/-] key. Since "EXECUTE: Enter (1sec)" is displayed. Pressing the [Enter] key for about 1 second changes the selected type and exits the setting mode.

Setting: AN:70Hz/ DG:95Hz/ DG:140Hz/ DG:760µs / DG:285Hz
Initial setting: DG:285Hz

⚠ WARNING

❗ The servo type parameter within the CGY760R must match the type of servo you are using. Incorrect setting may damage the CGY760R or the servo. Incorrect setting may also result in a loss of control during flight.

SWASH Type H3-120

(4) SWASH Type: Swash plare type

SWASH TYPE H3-120

Select the swash plate type. Move the cursor to "SWASH Type" by pressing the [▲/+] or [▼/-] key and press the [Enter] key to enter the setting mode. Then select the swash plate type with the [▲/+] or [▼/-] key. Since "EXECUTE: Enter (1sec)" is displayed. Pressing the [Enter] key for about 1 second changes the selected type and exits the setting mode. When you change the setting, other data is initialized.

Setting: H-1/ H3-120/ H3-140/ H3-90H3-90/ H4-00/ H4-45
Initial setting: H3-120

⚠ WARNING

❗ All of the swash plate parameters are reset when the swash plate type is changed. Please proceed through the entire setup process before attempting to fly the model.

Servo Dir # 1

(5) Servo Dir #: Servo direction

Servo Dir # 1

Using different servo combinations will create the proper swash plate servo movement electronic CCPM models (eCCPM) In the H3-xx swash mode, three of the swash servos directions are changed by pressing the [▲/+] or [▼/-] key. Choose the combination number which produces level swash plate travel with a collective pitch input from the transmitter. There are 8 combination choices for the H3-xx swash mode. On H4-xx swash mode, there are 16 combination choices. After selecting the combination number, aileron, elevator, pitch, and 2nd elevator servo parameters are automatically set.

NOTE: Occasionally the aileron or elevator function directions are reversed even though collective pitch direction is correct. In this case, change the direction of the affected function using the "SWS. Dir" parameter on "SWH. BASIC" screen 3/5.

From 1/5

H1 or H3	SWH. BASIC screen 2/5	H4
SWH.BASIC	2/5	SWH.BASIC 2/5
AIL.Ntr	+0	AIL.Ntr +0
ELE.Ntr	+0	ELE.Ntr +0
PIT.Ntr	+0	PIT.Ntr +0
		ELE2.Ntr +0

Go to 3/5 from any cursor position

AIL.Ntr +0

ELE.Ntr +0

PIT.Ntr +0

ELE2.Ntr +0

(6) AIL, ELE, PIT. Ntr: Servo neutral adjustment

AIL.Ntr +0	ELE.Ntr +0
PIT.Ntr +0	ELE2.Ntr +0

Use the [▲/+] or [▼/-] key to adjust the neutral position of the swash servo (aileron, elevator, pitch, second elevator). The second elevator (ELE2) is displayed only when the swash type is H4-xx.

Setting ranges: +240 ~ -240 Initial value: 0

ELE.2 is displayed only when the swash type is H4-xx

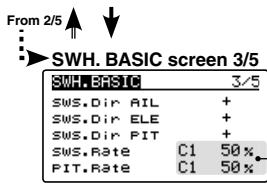

*The setting with "C#" display can be set for each condition.

1. Use the [▲/+] or [▼/-] key to move the cursor to "C#" and press the [Enter] key to enter the condition selection mode. Use the [▲/+] or [▼/-] key to select the condition number "C#" and press the [Enter] key to decide the condition number.
2. Next, move to the set value of the condition selected by the [▲/+] or [▼/-] key, and press the [Enter] key to enter the setting mode. Use the [▲/+] and [▼/-] keys to change the setting value. When you are done, press the [Enter] key to exit the setting mode.



(7) SWS. Dir: Swash direction setting



This selects the aileron, elevator and collective pitch direction. Reverse the direction when the stick movement and swash movement are opposite. Each time you press the [▲/+] or [▼/-] key, the polarity switches.

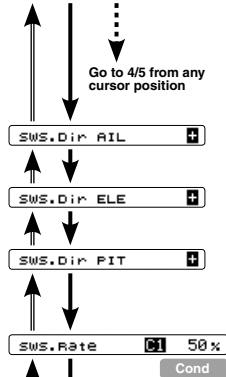

(8) SWS. Rate: Rate adjustment

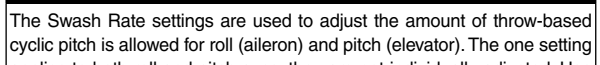

The Swash Rate settings are used to adjust the amount of throw-based cyclic pitch is allowed for roll (aileron) and pitch (elevator). The one setting applies to both roll and pitch axes; they are not individually adjusted. Use the [▲/+] or [▼/-] key to make an adjustment. (DUAL RATES MUST BE 100)

- Suggested amount of base cyclic pitch
- *800 size – 10 degrees
- *700 size – 9 degrees
- *600 - 550 size – 8 degrees
- *500 size 7 degrees
- *450 and below- 6 degrees

Setting ranges: 0 ~ 100% Initial value: 50%

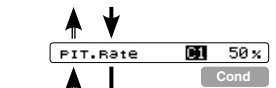

(9) PIT. Rate: Rate adjustment

The [PIT.Rate] is the amount of collective pitch travel allowed. A good starting range for Sport, 3D and F3C is +/-10 to +/-12 degrees. Use the [▲/+] or [▼/-] key to make an adjustment.

Setting ranges: 0 ~ 100 Initial value: 50%

SWH. BASIC screen 4/5

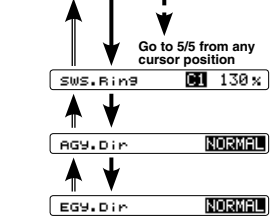

(10) SWS. Ring

This parameter is used to prevent binding of the swash plate servos when the transmitter control stick is moved toward a corner (for example, full right and full aft cyclic). Press the [▲/+] or [▼/-] key to adjust the value.

Setting ranges: 50 ~ 100% Initial value: 130%

(11) AGY. Dir: Aileron (roll) Gyro direction
EGY. Dir: Elevator (Pitch) Gyro direction



This parameter controls which direction the CGY760R (roll / pitch axis) will compensate when the helicopter rolls (pitches). Pick the helicopter up and roll the helicopter to the right. The CGY760R should compensate by adding left cyclic to the swash plate. (Pick the helicopter up and rotate the nose of the helicopter downward. The CGY760R should compensate by adding aft cyclic to the swash plate.) If the CGY760R compensates in the wrong direction, then it will be necessary to reverse the compensation direction setting by pressing the [▲/+] or [▼/-] key once.

⚠ WARNING

Verify that the CGY760R compensates in the correct direction before flight. If the compensation direction is incorrect the model will roll or pitch uncontrollably even before it leaves the ground.

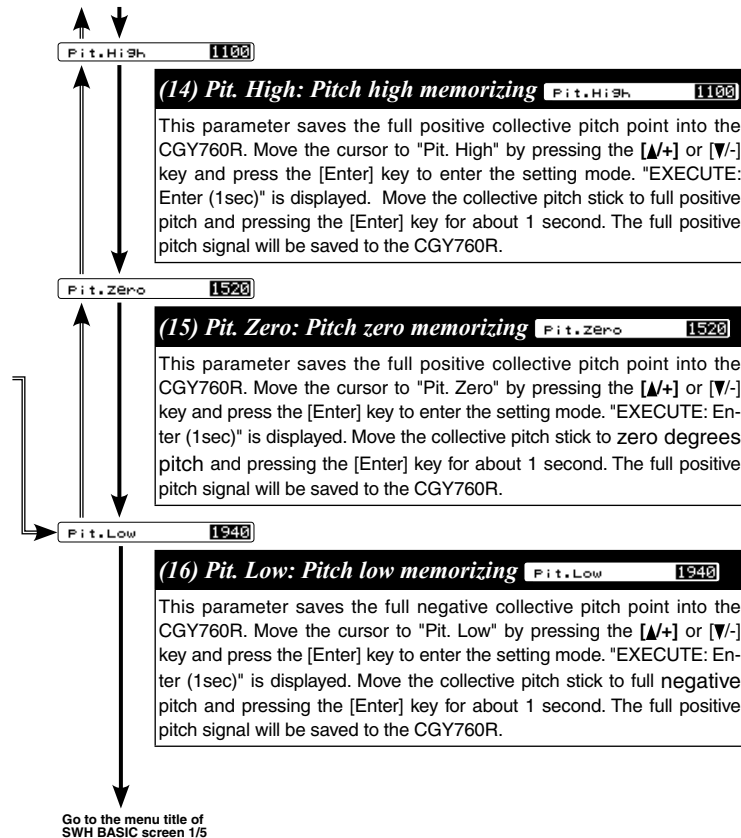
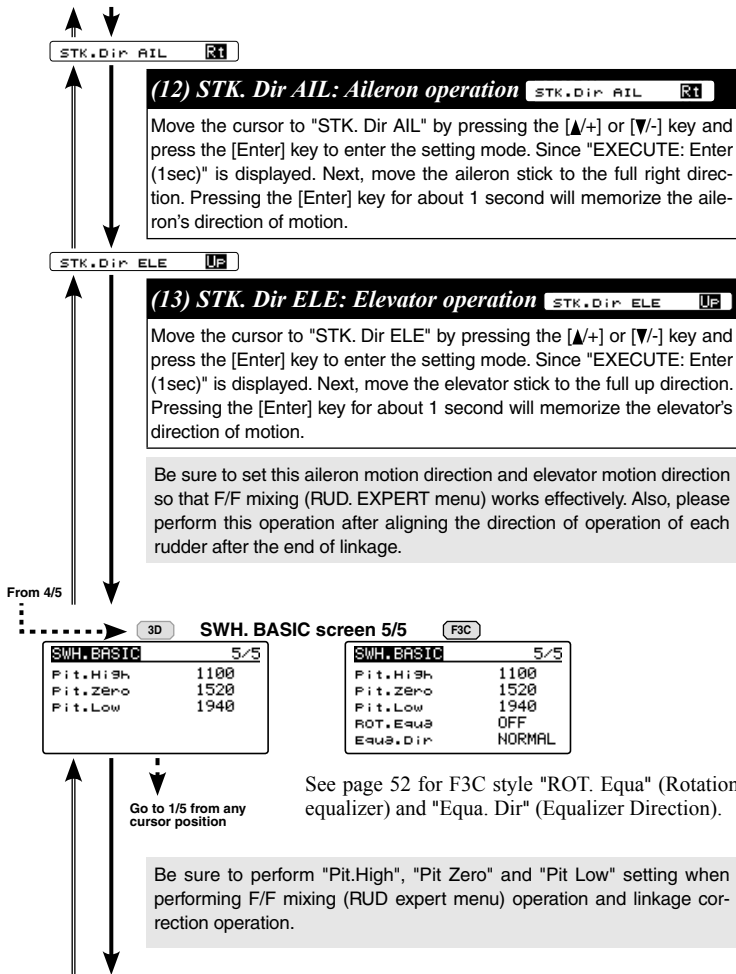

F3C style "ROT. Equa" and "Equa. Dir"

The following settings are displayed when "Setup Style" of page 45 is F3C. When it is 3D, it is not displayed in the automatic setting.

ROT.EQUA OFF F3C

ROT. Equa: Rotation equalizer ROT.EQUA OFF

This function stabilizes the helicopter by correcting the change of the rotor rotation surface at the time of the pyrouette. Move the cursor to "ROT.Equa" with the [▲/+] or [▼/-] key and press the [Enter] key to enter the setting mode. Select the ON or OFF of key with the [▲/+] or [▼/-] key. When you finish setting, press [Enter] key to exit setting mode.

EQUA.DIR NORMAL F3C

Equa. Dir: Equalizer Direction EQUA.DIR NORMAL

Sets the direction to correct for the phase equalizer and rotation equalizer. When entering this menu, the swash plate will tilt toward the elevator. I will remember the direction of the tilt. In this state, rotate the helicopter main body in the 90 deg ladder direction and set the correcting direction so that the inclination of the swash plate becomes the same direction. Move the cursor to "Equa.Dir" with the [▲/+] or [▼/-] key and press the [Enter] key to enter the setting mode. Each time you press the [▲/+] or [▼/-] key, the compensation direction changes. In order to operate the phase equalizer and the rotation equalizer normally, be sure to set the direction to correct exactly.

Operation check

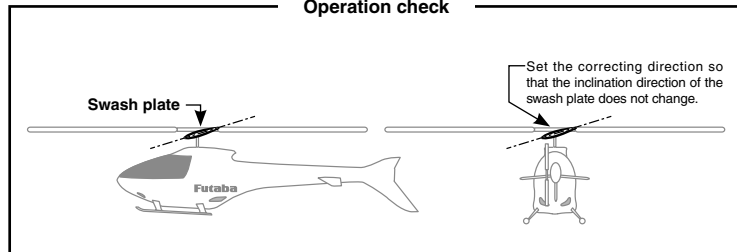

Installation And Setting Of Swash Servo

How to set the servo operation direction

1. Depending on the type of swash plate, place the servo as shown in the diagram on page 44.

2. (Initial setting on transmitter side)

Regardless of the swash plate type of helicopter to be set, set the transmitter setting to swash type "H-1".

* Swash mixing is done on the gyro side.

Set the reverse setting of aileron, elevator and collective pitch on the normal side. Set the operation amount (ATV / AFR / EPA) of aileron, elevator and collective pitch to 100%.

3. (Setting of swash plate type / see page 46)

In accordance with the swash plate of the helicopter to be used, set "Swash type" of "SWH. BASIC" menu.

4. (Servo type setting / see page 46)

In the "Servo Type" of the "SWH. BASIC" menu, select the type of servo that controls the swash plate.

* Use of digital servo is recommended.

5. (Neutral adjustment / see page 47)

Set the transmitter's collective pitch stick to the 0 deg pitch angle. Adjust the neutral of each servo with "AIL. Ntr" (aileron serve neutral), "ELE. Ntr" (Elevator serve neutral) and "PIT. Ntr" (collective pitch serve neutral) in the "SWH. BASIC" menu, on page 47 and each servo horn becomes perpendicular to the linkage rod match So adjust the neutral position. In this state, adjust the length of the linkage rod so that the swash plate surface is perpendicular to the rotor shaft.

6. (Setting of servo operation direction / see page 47)

Using different servo combinations will create the proper swash plate servo movement electronic CCPM models (eCCPM) In the H3-xx swash mode, three of the swash servos directions are changed by pressing the [▲/+] or [▼/-] key. Choose the combination number which produces level swash plate travel with a collective pitch input from the transmitter. There are 8 combination choices for the H3-xx swash mode. On H4-xx

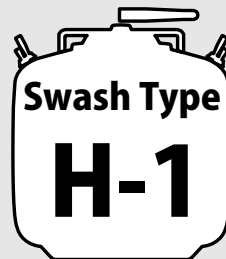

swash mode, there are 16 combination choices. After selecting the combination number, aileron, elevator, pitch, and 2nd elevator servo parameters are automatically set. Even if the swash plate servo moves in the same direction, the ailerons and elevators may move in opposite directions. At this time, reverse polarity with "SWS. Dir" of "SWH. BASIC" menu 3/5. Alternatively, reverse the aileron of the transmitter and the reverse setting of the elevator.

Adjust operation angle / see page 48, 49

Adjust the pitch motion of the aileron, elevator and collective pitch so that it moves at the specified angle by "SWS. Rate" and "PIT. Rate" in "SWH. BASIC" menu.

*Adjust the operating angle of the aileron, elevator and collective pitch of the transmitter (ATV / AFR / EPA) to 100%.

Swash ring setting / see page 53

Set the maximum inclination amount of the swash plate with "SWS. Ring" of "SWH. BASIC" menu.

*Set to the maximum value at which the linkage will not interfere when the aileron and elevator move simultaneously at the full positive collective pitch point and negative collective pitch point.

Linkage correction method

A helicopter with a swash type of H3-120 is taken as an example and the linkage correction method is explained.

*For the setting of the transmitter, please select the flight condition where the control angle of each servo becomes the maximum.

1. (pitch calibration)

Load pitch angle with "Pit. Zero", "Pit. Low" and "Pit. High" in the "SWH. BASIC" menu. (page 54 - 55)

•Set the collective pitch stick to the full positive collective pitch position. Move the cursor to "Pit. High" by pressing the [▲/+] or [▼/-] key and press the [Enter] key to enter the setting mode. "EXECUTE: Enter (1sec)" is displayed. Move the collective pitch stick to zero degrees pitch and pressing the [Enter] key for about 1 second.

The full positive collective pitch position is memorized.

•Set the collective pitch stick to the pitch angle 0 degree position. Move the cursor to "Pit. Zero" by pressing the [▲/+] or [▼/-] key and press the [Enter] key to enter the set-

ting mode. "EXECUTE: Enter (1sec)" is displayed. Move the collective pitch stick to zero degrees pitch and pressing the [Enter] key for about 1 second.

The pitch angle 0 degree position is memorized.

- Set the collective pitch stick to the full negative collective pitch position. Move the cursor to "Pit. Low" by pressing the [▲/+] or [▼/-] key and press the [Enter] key to enter the setting mode. "EXECUTE: Enter (1sec)" is displayed. Move the collective pitch stick to zero degrees pitch and pressing the [Enter] key for about 1 second. The full negative collective pitch position is memorized.

2. (Correction in the pitch direction / see page 86)

Make sure that the swash plate is level when collective pitch stick is also in position with full positive pitch.

If the swash plate is not level, adjust the rate of "PIT→AIL" and "PIT→ELE" in "SWH.DETAIL" menu of "EXPERT MENU" so that the swash plate becomes level. Adjust same at the full negative collective pitch position as well.

3. (Correction of aileron (roll direction) / see page 87)

•When the collective pitch stick is at the pitch angle 0 degree position

Move the aileron stick left and right at the collective pitch stick 0 degree pitch angle position. At this time, confirm that there is no interference with the collective pitch and the elevator (pitch). If there is interference, adjust the rate so that interference will be minimized by "AIL→PIT" in "SWH.DETAIL" menu of "EXPERT MENU". Adjust in both right and left direction of aileron.

•When the collective pitch stick is at the full positive collective pitch position

Move the aileron stick left and right at the full positive collective pitch position. At this time, confirm that there is no interference with the collective pitch and the elevator (pitch). If there is interference, adjust the rate so that interference will be minimized by "COMPENSATION AIL High" in "SWH.DETAIL" menu of "EXPERT MENU". Adjust in both right and left direction of aileron. If interference increases by adjusting "LEFT / RIGHT" of "COMPENSATION AIL High", reverse the correction direction of "AIL Dir".

•When the collective pitch stick is at the full negative collective pitch position

Move the aileron stick left and right at the full negative collective pitch position. At this time, confirm that there is no interference with the collective pitch and the elevator (pitch). If there is interference, adjust the rate so that interference will be minimized by "COMPENSATION AIL Low" in "SWH.DETAIL" menu of "EXPERT MENU". Adjust in both right and left direction of aileron.

4. (Correction of elevator (pitch direction) / see page 88)

•When the collective pitch stick is at the pitch angle 0 degree position

Move the elevator stick up and down at the collective pitch stick 0 degree pitch angle position. At this time, confirm that there is no interference with the collective pitch and the aileron (roll). If there is interference, adjust the rate so that interference will be minimized by "ELE→PIT" and "ELE→AIL" in "SWH.DETAIL" menu of "EXPERT MENU". Adjust in both Up and down direction of elevator.

•When the collective pitch stick is at the full positive collective pitch position

Move the elevator stick up and down at the full positive collective pitch position. At this time, confirm that there is no interference with the collective pitch and the aileron (roll). If there is interference, adjust the rate so that interference will be minimized by "COMPENSATION ELE High" in "SWH.DETAIL" menu of "EXPERT MENU". Adjust in both Up and down direction of elevator.

•When the collective pitch stick is at the full negative collective pitch position

Move the elevator stick up and down at the full negative collective pitch position. At this time, confirm that there is no interference with the collective pitch and the aileron (roll). If there is interference, adjust the rate so that interference will be minimized by "COMPENSATION ELE Low" in "SWH.DETAIL" menu of "EXPERT MENU". Adjust in both Up and down direction of elevator.

FLT. TUNE MENU (FLIGHT TUNING SETTING)

Flight tune sets control of helicopter roll (aileron) and pitch (elevator) axis. Refer to page 39 and display the "FLT. TUNE" screen from the "BASIC MENU" screen. The contents of part of the setting change in "Setup Style" of page 45 in F3C or 3D.

From 3/3... :>>> From the "HP.Auth." of FLT. Tune screen 3/3

3D FLT. TUNE screen 1/3 (F3C)

Go to 2/3 from any cursor position

See page 61 for F3C style "Work. Mode" (Gyro working mode) and "AIL. Sep3" (Aileron gain separation).

(1) Base. Gain: Gyro base gain setting Base Gain 100%

This sets the Cyclic Gyro Base Gain. If the aileron and elevator Gain Channels are set to "INH" within the CGY760R "SBUS.BASIC" menu, then the remote transmitter gain adjustment is not available. Thus the actual working gain for the cyclic gyros is set by using the [▲/+] or [▼/-] key within this parameter.

Set to 100, a TX Gain value of 100% will display 100% on the GPB-1. If a pilot is in need of more gain, base gain can be increased to allow the gain on the CGY760R to be higher than 100%.

NOTE: If using a 6CH or less "Base Gain" is equivalent to the rotor head gain and can be adjusted manually on the gyro instead of via TX.

Setting ranges: 0 ~ 150% Initial value: 100%

(2) CYC. Rt: Cyclic rate setting CVC.Rt 01 300 d/s

Cyclic rate sets the maximum cyclic pitch and roll rate (d/s) as limited by the model's ability to reach that set rate. Pitch and roll rates are set together with this single parameter. The cyclic rate is set by using the [▲/+] or [▼/-] key.

Setting ranges: 10 ~ 500d/s Initial value: 300d/s

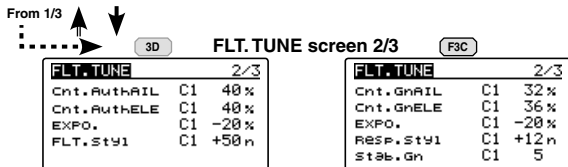

See page 61 for F3C style "Stab. Gn" (Stability gain).

Go to 3/3 from any cursor position



(3) Cnt. AuthAIL: Control Authority Aileron

Cnt. AuthAIL C1 40% Cnt. GnAIL C1 32% (Cnt. GnAIL)

Aileron Control Authority (Aileron Control Gain-F3C) changes the rate at which the gyro will try to achieve the set "CYC. Rt". A higher value will create a quicker accelerated reaction to a stick input to reach and stabilize to the "CYC. Rt" value; a lower value will reach the desired "CYC. Rt" slower and accelerate slower to the desired angular rate.

NOTE: Setting this value too high could lead to a jerky feeling when making FAST stick corrections, a value too low will give you the impression the model is not following the pilot's stick inputs. Values of 30-70 are useful for most helicopters.

Setting ranges: 0 ~ 100%

Initial value: Cnt. AuthAIL 3D = 40% / Cnt. GnAIL F3C = 32%



(4) Cnt. AuthELE: Control Authority Elevator

Cnt. AuthELE C1 40% Cnt. GneELE C1 36% (Cnt. GnAIL)

Elevator Control Authority (Elevator Control Gain-F3C) changes the rate at which the gyro will try to achieve the set "CYC. Rt". A higher value will create a quicker accelerated reaction to a stick input to reach and stabilize at the "CYC. Rt" value; a lower value will reach the desired "CYC. Rt" slower and accelerate slower to the desired angular rate.

NOTE: Setting this value too high could lead to a jerky feeling when making FAST stick corrections, a value too low will give you the impression the model is not following the pilot's stick inputs. Values of 30-70 are useful for most helicopters.

Setting ranges: 0 ~ 100%

Initial value: Cnt. AuthELE 3D = 40% / Cnt. GneELE F3C = 32%

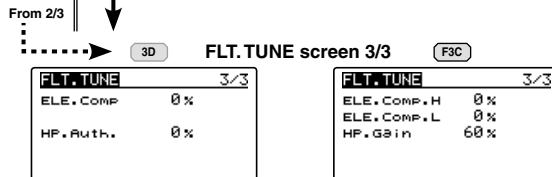
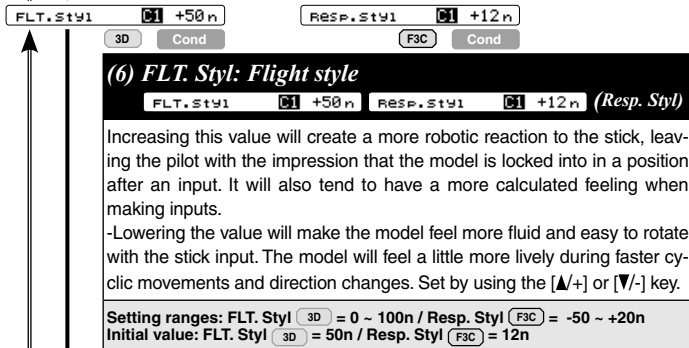
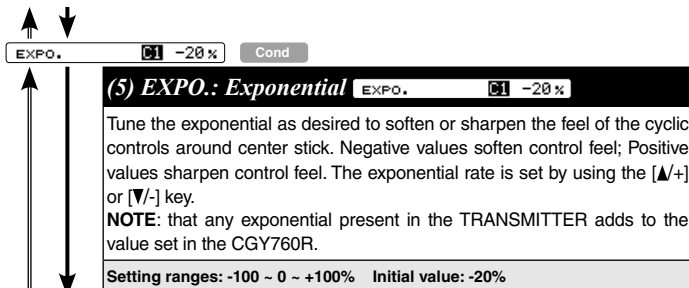

Go to 1/3 from any cursor position

NOTE: To effectively operate the next "ELE Comp" (elevator correction), make sure to set "Pit High", "Pit Zero", "Pit Low" on the "SWITCH BASIC" menu on page 51.

ELE. Comp 0% 3D

(7) ELE. Comp: Elevator pre compensation

On a clockwise rotating disk helicopter naturally will want to pull the nose towards the rotor disk with positive blade pitch and push the nose away with negative pitch. In an instance of a slower servo set-up or larger (heavier) rotor blades, a small amount of elevator pre compensation may be needed to keep the nose of the helicopter flat at all times during collective pitch changes. In most cases with helicopter high speed servos and standard 3D rotor blades, this function is not needed. If you do notice a slight tendency for the nose to try to rise or fall with collective input, increasing "ELE Comp" will reduce this behavior.

Setting ranges: 0 ~ 100% Initial value: 0%

ELE. COMP. H 0% F3C

When "Setup Style" on page 45 is "F3C" elevator pre compensation is adjusted separately for low and high.

ELE. COMP. L 0% F3C

HP. Auth. 0% 3D

HP. Gain 60% F3C

(8) HP. Auth.: High pitch authority

HP. Auth. 0% HP. Gain 60% (HP. Gain)

On a clockwise rotating disk helicopter naturally will want to pull the nose towards the rotor disk with positive blade pitch and push the nose away with negative pitch. In an instance of a slower servo set-up or larger (heavier) rotor blades, a small amount of elevator pre compensation may be needed to keep the nose of the helicopter flat at all times during collective pitch changes. In most cases with helicopter high speed servos and standard 3D rotor blades, this function is not needed. If you do notice a slight tendency for the nose to try to rise or fall with collective input, increasing "ELE Comp" will reduce this behavior.

Setting ranges: 0 ~ 100% Initial value: HP. Auth. 3D = 0% /HP. Gain F3C = 60%

Go to the menu title of FLT. TUNE screen 1/3

F3C style "Work Mode", "AIL. Sepa" and "Stab. Gn"

The following settings are displayed when "Setup Style" of page 45 is F3C.

FLT. TUNE screen 1/3

Work Mode CMT F3C

Work Mode: Gyro working mode

The available choices are CMT, Normal or AVCS. The CMT mode will allow you to select either AVCS or Normal mode via the transmitter. In Normal mode the gyro will always operate in Normal Rate Mode, and when AVCS it will always operate in AVCS Mode. Use the [▲/+] or [▼/-] key to select the desired working mode.

Setting: CMT / Normal / AVCS Initial setting: CMT

AIL. Sepa 6pnt F3C

AIL. Sepa: Aileron gain separation

This parameter sets the aileron and elevator of the gyro gain separation. 6pnt means the aileron gain is lesser 6 points with elevator gain. It is useful when the aileron and elevator gain channels are set to same channel and aileron and elevator gain are adjusted at the same time. The rationale for this parameters lies in the fact that most models functionally will tolerate more gyro gain on the elevator axis than on the aileron axis.

Setting ranges: 0 ~ 10% Initial value: 0%

FLT. TUNE screen 2/3

Stab. Gn C1 5 F3C Cond

Stab. Gn: Stability gain

Depending on many variables such as model, rotor blade design, head speed, head dampening, and servo choice, the amount of transmitter cyclic gyro gain that the model will tolerate without oscillation may be lower than the percentage that provides the most stable flight. If the model is observed to be oscillating or wobbling at your chosen headspeed with low transmitter cyclic gyro gain percentages, lowering the Stability.Gn parameter a point or two will allow for higher cyclic gyro gain without inducing a wobble or oscillation in the model.

Setting ranges: 1 ~ 10 Initial value: 5

RUD. BASIC MENU (RUDDER GYRO BASIC SETTING)

In the "RUD. BASIC" menu, you make the basic setting of the rudder gyro. Refer to page 39 and display the "RUD. BASIC" screen from the "BASIC MENU" screen.

⚠ WARNING

⚠ Do not connect the tail rotor servo to the gyro until the servo type has been selected. Operating the servo using the incorrect setting may damage the CGY760R or the servo.

⚠ Do not operate with the linkage connected until the "Srv. Limit" function correctly sets the servo limit point. If the servo operates beyond the linkage operating range, there is a danger of servo or helicopter being damaged.

Setting on transmitter side

The following transmitter setting example shows the case of using Futaba GY gyro mixing. Please read in accordance with your system.

1. Enable rudder gyro mixing.
2. In the gyro mode select "GY".
3. Temporarily set the gyro sensitivity of normal condition and hold condition to AVCS 75%. Also, temporarily set the gyro sensitivity of all idle up conditions to AVCS 50%.
4. Set the channel angle setting function (ATV / AFR / EPA) of the rudder channel and sensitivity setting channel to 100%.
5. Temporarily set the D/R function of the rudder channel to 75% both left and right.
6. We recommend that you temporarily set the EXP function of the ladder channel to about -30% (mild side 30%).

* Adjust the temporary setting of each item above to the optimum value by the later test flight.

From 2/2 >>> From the "Work Mode." of RUD. BASIC screen 2/2

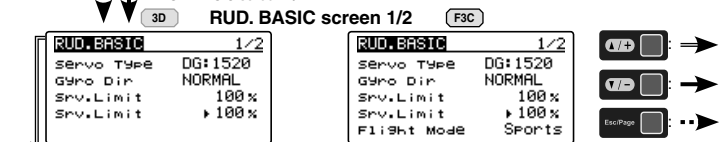

See page 65 for F3C style "Flight Mode".

⚠ WARNING

⚠ The servo type parameter within the CGY760R must match the type of servo you are using. Incorrect setting may damage the CGY760R or the servo. Incorrect setting may also result in a loss of control during flight.

Servo Type DG:1520

(1) Servo Type Servo Type DG:1520

Select the appropriate setting for the tail rotor servo. Move the cursor to "Servo Type" by pressing the [▲/+] or [▼/-] key and press the [Enter] key to enter the setting mode. Then select the servo types: DG1520, DG760 or Analog with the [▲/+] or [▼/-] key. Since "EXECUTE: Enter (1sec)" is displayed. Pressing the [Enter] key for about 1 second changes the selected type and exits the setting mode.

Setting: Analog / DG:1520 / DG760
Initial setting: DG:1520
DG 1520: BLS254, BLS257, S9254, S9257
DG 760: BLS276SV, BLS251SB, BLS251, S9256, S9251

Gyro Dir NORMAL

(2) Gyro. Dir: Gyro direction Gyro Dir NORMAL

This parameter controls which direction the CGY760R (yaw axis) will compensate when the helicopter rotates. Hold the tail rotor linkage over the linkage ball on the servo, pick the helicopter up by the main shaft and rotate the mechanics counter-clockwise. The CGY760R should compensate by adding clockwise rotation pitch to the tail rotor blades. If the CGY760R compensates by adding counter-clockwise rotation pitch to the tail rotor blades, then it will be necessary to reverse the Compensation Direction setting by pressing the [▲/+] or [▼/-] key.

Setting value: Normal / Revers Initial value: Normal

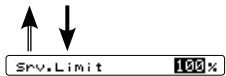

(3) Srv. Limit: Limit setting

Srv.Limit 100%

When the CGY760R is in the "Srv.Limit" parameter the gyro will no longer operate and the tail servo will always center when the tail rotor stick is released. Always exit setup functions before attempting to fly the model. Before each flight always ensure that the gyros are operating and compensating in the correct direction. The Servo Limit parameter within the CGY760R is used to set the mechanical limits for the tail rotor servo. To obtain the best performance it is recommended to set the limit in the CGY760R to 100% for both directions and then adjust the servo arm length to set the mechanical endpoints. After that has been completed use the servo limit parameter to make small adjustments that could not be made mechanically. Values between 90% and 110% are considered optimal. Hold the cursor to "Srv.Limit" by pressing the [▲/+] or [▼/-] key. Gradually move the rudder stick to the left or right by the maximum amount the "►" cursor moves. Enter the setting mode by pressing the [Enter] key, increase or decrease the maximum throw using the [▲/+] or [▼/-] key, and then press the [Enter] key to exit the setting mode. Set the same way on the other side. Make sure that the pitch slider does not restrain beyond the maximum movement amount.

⚠ WARNING

❗ When using the CGY760R for the first time, or when making mechanical changes involving throw, you must check and set the servo limits again to prevent binding.

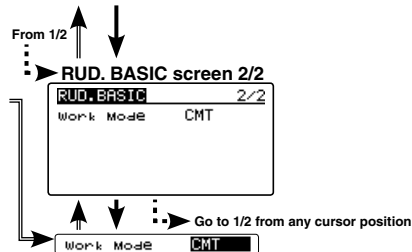

(4) Work Mode: Gyro working mode

Work Mode CMT

The available choices are CMT, Normal or AVCS. The CMT mode will allow you to select either AVCS or Normal mode via the transmitter. In Normal mode the gyro will always operate in Normal Rate Mode, and when AVCS it will always operate in AVCS Mode. Use the [▲/+] or [▼/-] key to select the desired working mode.

Setting: CMT / Normal / AVCS Initial setting: CMT

Go to the menu title of RUD. Basic screen 1/2

F3C style "Flight Mode"

The following settings are displayed when "Setup Style" of page 45 is F3C.

Flight Mode Sports F3C

Flight Mode Flight Mode Sports

Set the flight style. The Sports mode enables fine ladder operation. In 3D mode ladder operation becomes sensitive, and the pyrouette speed is also set fast. Use the [▲/+] or [▼/-] key to select the desired flight mode. Since "EXECUTE: Enter (1sec)" is displayed. Pressing the [Enter] key for about 1 second changes the selected mode and exits the setting mode.

Setting: Sports / 3D Initial setting: Sports

GOV. BASIC MENU (GOVERNOR BASIC SETTING)

This menu sets the governor's fundamental functions. The menu Servo limit point setting must be set first. Refer to page 39 and display the "GOV. BASIC" screen from the "BASIC MENU" screen.

From 6/6 ... From the "SBUS2 rpm Slot" of GOV. BASIC screen 6/6

GOV. BASIC screen 1/6

GOV. BASIC 1/6

Governor ACT

Gear Ratio 8.00 t

Pole Num. 2P

Servo Type Analog

Go to 2/6 from any cursor position

(1) Governor: Governor active Work Mode CMT

Set the governor operation mode of CGY760R. The initial setting is "ACT (active)" where the governor operates. If you do not want to use governor, select "INH (Inhibit)".

Setting: ACT (active) / INH (Inhibit) Initial setting: ACT

Governor ACT

(2) Gear Ratio: Gear Ratio 8.00 t

Input the main rotor gear ratio by pushing the [▲/+] or [▼/-] key to select the desired working mode.

Setting ranges: 1.00 ~ 50.00t Initial value: 8.00t

Notes:

- If the gear ratio is not properly set, the set speed and actual engine speed will be different.
- The gear ratio should be given in the helicopter instruction manual. If the helicopter instruction manual does not give the gear ratio, calculate the gear ratio as follows:

Engine pinion gear N2

Rotor main gear N1

Gear ratio = N1/N2

Carry values less than 1/1000 to the next whole number.

Gear Ratio 8.00 t

(3) Pole Num.: Pole number Pole Num. 2P

This parameter is used when using a direct phase sensor attachment to a brushless motor lead. Input the motor pole count as specified by the brushless motor manufacturer. When using any revolution sensor other than a direct phase sensor type, set the pole number to 2p.

NOTE: For nitro use, set to 2p.

NOTE: The input signal range of the CGY760R is 0.0v-3.0v. Exceeding this voltage range may cause damage to the CGY760R.

Setting ranges: 2 ~ 24P Initial value: 2P

Pole Num. 2P

(4) Servo Type Servo Type Analog

Select the throttle servo type. Digital servos offer the best response. Move the cursor to "Servo Type" by pressing the [▲/+] or [▼/-] key and press the [Enter] key to enter the setting mode. Then select the servo type with the [▲/+] or [▼/-] key. Pressing the [Enter] key exits the setting mode.

Setting: Analog / DG:1520 Initial setting: Analog

WARNING

⚠ The servo type parameter within the CGY760R must match the type of servo you are using. Incorrect setting may damage the CGY760R or the servo. Incorrect setting may also result in a loss of control during flight.

Servo Type Analog

GOV. BASIC screen 2/6

GOV. BASIC 2/6

RPM Set 3 000 Off

Stick SW ON 230%

ON/OFF SW INH

BAT F/S INH

Go to 3/6 from any cursor position

RPM Set 1 1000 RPM

RPM Set 2 1500 RPM

RPM Set 3 2000 RPM

From 1/6

GOV. BASIC screen 2/6

GOV. BASIC 2/6

RPM Set 3 000 Off

Stick SW ON 230%

ON/OFF SW INH

BAT F/S INH

Go to 3/6 from any cursor position

RPM Set 1 1000 RPM

RPM Set 2 1500 RPM

RPM Set 3 2000 RPM

(5) RPM set.: RPM setting RPM Set 1 1000 RPM

Setting the main rotor RPM. This is calculated by engine revolution with the gear ratio of the main shaft.

When the rotation speed can be set with the governor mixing function of the transmitter, it is necessary to first match the display rpm value of 1-2-3 of "RPM Set" with the display rpm value of the transmitter.

Setting ranges: off / 700 ~ 4,000rpm **Initial value:** 1,000rpm

*To set lower than 1,000 rpm, set "Low. Revo" (page 108) of "GOV. EXPERT" menu to 700 rpm.

Stick SW OFF 0%

(6) Stick sw.: Stick switch Stick SW OFF 0%

The governor can be activated by throttle stick position. Move the cursor to "Stick sw" by pressing the [▲+] or [▼-] key and press the [Enter] key to enter the setting mode. "EXECUTE: Enter (1sec)" is displayed. Move the throttle stick to the desired governor on position and pressing the [Enter] key for about 1 second, memorizing that point.

This stick switch function is always enabled when the next "ON/OFF sw" is "INH" or the "Governor ON / OFF switch is not set by S.BUS setting.

When governor is turned on and off by transmitter throttle stick

The data is set so that the governor can be turned on and off with the transmitter throttle stick. The following describes this operation.

- Throttle stick over set point and more than 60% of set rotation speed →→→ ON

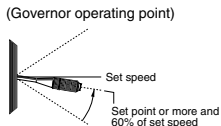

- Throttle stick held at the set point or more Remains →→→ ON



- Throttle stick lowered past the set point or less than the slow side →→→ OFF

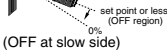

When idle up

- When the throttle curve is set at idle up, when the throttle output is over the set value (initial value: 30%), it will always remain ON even if the stick is lowered to the bottom.

ON/OFF SW INH

(7) ON/OFF sw.: Governor on/off switch ON/OFF SW INH

This parameter allows turning of the governor on and off via a transmitter switch. Pressing the [▲+] or [▼-] key activates the function. Choose INH if you do not want to use it.

When turning on / off governor with switch

In advance, select the ON / OFF switch channel with "GOV sw channel" on "S.BUS BASIC" menu on page 41.

When governor turned on and off by switch. Setting the switch to the ON position turns on the governor. The following describes this operation.

- Switch set to on position and engine running at 60% or more of set speed →→→ ON
- Throttle stick set to maximum slow position →→→ ON
- Switch set to off position →→→ OFF

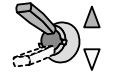

Governor can be turned on and off by a switch.

ON/OFF SW ON REV

When you activate the switch, the direction setting of the switch is displayed. Select the switch ON / OFF direction (NORM / REV) with the [▲+] or [▼-] key.

BAT F/S INH

(8) BAT F/S: Battery fail safe BAT F/S INH

When the receiver battery voltage becomes equal to or less than "BFS. Volt" (page 108) set in the "GOV EXPERT" menu, the battery fail safe function is activated, the governor function is turned OFF, and the throttle servo moves to the set position.

BAT F/S ACT 0%

When Battery Fail Safe is enabled, items for setting the throttle servo position are displayed. The setting method is the same as "Stick sw", so please refer to it.

From 2/6
GOV. BASIC screen 3/6

GOV. BASIC 3/6
Lim.Set Id SET
Lim.Set Hi SET
Limit Test Idle HIGH

Lim.Set Id SET

(9) Lim. set.: Servo limit point setting

Lim.Set Id SET Lim.Set Hi SET

Servo limit point setting defines the overall travel range for the throttle servo. It is fundamental for governor operation and must be set prior to other functions. Servo limits must also be reset when the throttle linkage or trim are changed. Refer to the next page for setting.

⚠ WARNING

❗ When using the CGY760R for the first time, or when making changes in the throw of a servo and its linkage, always perform the limit setting operation.

How to set the servo limit point:

Set the transmitter's throttle stick to the idle position. Select [Lim. Set Id] with the [▲/+] or [▼/-] key and press the [Enter] key to enter the setting mode. "EXECUTE: Enter (1sec)" is displayed. Press the [Enter] key for about 1 second. The cursor will move to "Lim. Set IH". Set the stick to the full high position and set the same as "Lim. Set Id". If the setting data is not normal (servo operation amount is 50% or less), "Err" is displayed. In this case, check the transmitter setting and execute the above set again.

Limit Test Idle HIGH

(10) Limit Test: Battery fail safe Limit Test Idle HIGH

Check the set limit point. Use the [▲/+] or [▼/-] key to move the cursor to "LIMIT Test Idle" and press the [Enter] key to move the servo to the idle point and display "END". Similarly on the high side, use the [▲/+] or [▼/-] key to select the cursor "LIMIT Test HIGH" and test it with the [Enter] key.

From 3/6

GOV. BASIC screen 4/6

```
GOV. BASIC      4/6
Response       Middle
GOV.Gain       C1 40%
L Lmt.Hov      C1 25%
L Lmt.IdUp     C1 45%
```

Go to 5/6 from any cursor position

Response Middle

(11) Response Response Middle

This parameter selects the governor operation response. Select the best match for your engine type. Pushing data+ or - key, the mode is changed. Recommended selection are, Middle → glow engine, Moderate → gasoline engine, Quick → brushless motor, Silent → electric models when RPM detection is accomplished either with a magnet on the motor's rotor or with a brushless phase sensor.

*The setting with "C1" display can be set for each condition.

1. Use the [▲/+] or [▼/-] key to move the cursor to "C#" and press the [Enter] key to enter the condition selection mode. Use the [▲/+] or [▼/-] key to select the condition number "C#" and press the [Enter] key to decide the condition number.
2. Next, move to the set value of the condition selected by the [▲/+] or [▼/-] key, and press the [Enter] key to enter the setting mode. Use the [▲/+] and [▼/-] keys to change the setting value. When you are done, press the [Enter] key to exit the setting mode.

GOV.Gain C1 40% Cond

(12) GOV Gain: Governor gain GOV.Gain C1 40%

Governor Gain. Too low of number the RPM will fluctuate with collective pitch and cyclic changes. Too high of gain the RPM will oscillate and possibly surge during flight.

Setting ranges: 1 ~ 100%

Initial value: Middle = 40%, Moderate = 30%, Quick = 60%, Silent = 10%

L Lmt.Hov C1 25% Cond

L Lmt.IdUp C1 45% Cond

(13) L Lmt. Hov / Idle : Low limit RPM

L Lmt.Hov C1 25% L Lmt.IdUp C1 45%

Low RPM Limit sets the minimum amount of throttle that the governor will command during an over-speed situation. Too low of value the engine could shut off or not recover power quickly enough during the next collective movement. If the value is set too high, the governor will not control overspeed with the rotor head is unloaded.

Use:

L Lmt. Hov: For RPMS of 700-1700

L Lmt. Idle: For RPMS of 1701-4000

Setting ranges: L Lmt. Hov = 0 ~ 80%, L Lmt. Idle = 10 ~ 80%

Initial value: L Lmt. Hov = 25%, L Lmt. Idle = 45%

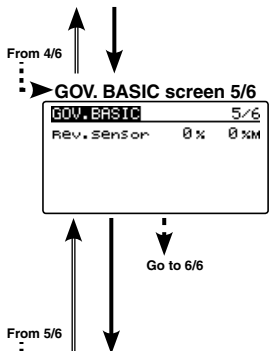

(14) Rev. Sensor: Revolution sensor testing

It tests the output level of the revolution sensor. No key operation is necessary. When this GOV basic 5/6 screen is displayed, it displays a test display. Turn the engine by hand, and check the output level. The display indicates the current level on left side numbers, maximum level on right side numbers. The output level needs to be more than 60% for correct governor operation. Also, when using the backplate sensor, the signal level of the backplate sensor varies depending on the rotation speed (3,000 rpm or more is the detectable rotation speed). For the test method, do not heat the plug, use the starter to check.

By the telemetry function, the number of revolutions read by the governor sensor can be displayed on the monitor of the transmitter. In order to be able to display, activate the telemetry rotation sensor (SBS-01RM) on the transmitter and set the gear ratio to 1.00.

NOTE: It can not be used when the transmitter is FASSTest 12CH system.

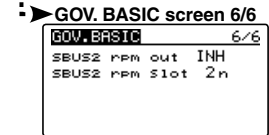

SBUS2 rpm out ACT

(15) SBUS2 rpm out: RPM display on transmitter

SBUS2 rpm out ACT

When displaying the rpm with the telemetry function, set it to ACT.

Setting: ACT (active) / INH (Inhibit) Initial setting: INH

SBUS2 rpm slot 2n

(16) SBUS2 rpm Slot: RPM display on transmitter

SBUS2 rpm out ACT

Set the slot number of the telemetry rotation sensor registered on the transmitter side.

Go to the menu title of GOV. BASIC screen 1/6

Governor Speed Setting

The CGY760R's rpm selection is accomplished by setting the channel in the section (8) "RPM channel" menu within the "S.BUS Basic Setting" to the governor speed setting channel of your system (page 41). When using an independent governor on/off switch, activate the section (7) "Governor on/off switch" function within the "Governor Basic Setting" section earlier in this manual (page 69).

Direct set by transmitter on Gov. mixing

- When governor mixing is used to switch the RPM of the rotor head speed, the head speed can be switched with each condition or the switch.

- For a description of the governor mixing, refer to your transmitter's manual.

Using by 3 position switch

- Set the RPM at each switch position in the "(2) RPM setting" menu within the "Governor Basic Setting" section earlier in this manual (page 68).

Governor operation

The CGY760R operates from 700 to 4000rpm main rotor speed. However, the engine must be running at the set speed. The CGY760R turns off the governor when the engine is starting or idling.

Condition of the governor to be on

For safety purposes, the governor is turned on when the conditions below are satisfied.

- The on/off switch conditions are set to off during power on.
- The stick switch is in the on position when it is used.
- The on/off switch is in the on position when it is used.
- Setting speed is not off.
- The engine speed exceeds to 60 % of the setting speed.
- The speed sensor is working properly.

⚠WARNING

⚠ Safety reminder: Remember to configure your transmitter fail safe settings for not only the throttle channel but also governor ON/OFF channel to ensure the governor correctly disengages should the radio enter fail safe.

RECOMMENDED GYRO GAIN SETTINGS

Recommended gain settings:

The optimum sensitivity is the position just before starting hunting. Adjust with actual flight.

Size	Recommended Gyro Gain	
	AIL/ELE Gyro	RUD Gyro
450-550	45 ~ 55%	45 ~ 55%
600-700	50 ~ 60%	50 ~ 60%
750-more	55 ~ 65%	55 ~ 65%

*50% is a good starting point for rudder gain regardless of model size.

ADJUSTMENTS DURING THE TEST FLIGHT

Pre-flight checklist

- Check that the transceiver's battery is fully charged.
- Check whether the gyro tape is torn or peeled.
- Turn on the transmitter / receiver and initialize the gyroscope.
- Check whether the servo type setting matches the servo being used (ladder / swash).
- Check that the servo horn is neutral and perpendicular to the push rod. (Ladder / Swash).
- Even if each rudder is manipulated to the maximum, it is confirmed whether there is a stroke of the servo operation (ladder / swash).
- Check that the gyro is operating in the correct mode (AVCS or normal) (ladder / aileron / elevator).
- Check whether the operation of each rudder matches the operation of the tail rotor / swash plate.
- When rotating the aircraft body, make sure that corrective action is performed in the correct direction.
- Is the gyro sensitivity set correctly for all flight conditions? Also, check whether it is operating in the correct mode (AVCS or normal).

WARNING

! Always level the swash plate using the cyclic stick before applying throttle and spooling the main rotor blades up. During takeoff small corrections may be necessary. If you make large corrections while the helicopter is on the ground, it may tip over since the helicopter is firmly on the ground and the gyros are over-compensating due to the lack of movement.

! Some helicopters may have a tendency to resonate/shake during spool up. Always leave the helicopter on the ground until this resonance or shaking goes away. If this issue continues, it is recommended to try some rubber skid stops or take off from a softer surface such as grass. Vibrations contribute to this ground resonance. Verify that everything on your model is balanced correctly. **yond the linkage operating range, there is a danger of servo or helicopter being damaged.**

*When the CGY760R is used with a ESC or BEC and a power switch is not used there is a possibility that the intermittent connection as you connect the flight battery may cause the CGY760R initialization to fail. Always ensure that the gyro has initialized properly by verifying that the gyros are compensating as the helicopter is moved. It is recommended to use a power switch on the power supply line to avoid this possibility.

Rudder Gyro Trim Flight:

The tail rotor/rudder AFR or D/R function within the transmitter is used to adjust the pirouette rate of the helicopter to suit your requirements. Do NOT use ATV or rudder channel travel adjustment for this purpose. For optimum performance, the tail rotor should be trimmed in Normal/Rate mode as closely as possible with adjustments to the tail rotor pushrod length before finalizing with transmitter trim and then memorizing that value into the CGY760R.

The tail rotor gyro gain should be raised until the tail begins to oscillate quickly (also called tail "wag"). Once this point has been achieved, reduce the gain as needed a few percent at a time to eliminate the oscillation. Repeat the process for all flight conditions. The main rotor speed, tail rotor ratio, tail rotor pitch range and tail blade length play a large part in achieving optimum tail rotor performance. The gain value can vary drastically from model to model, and the exact value should not play a part in the evaluation of the gyro's performance.

⚠ WARNING

ⓘ Safety Reminder: Remove both main and tail blades from the model and/or disengage the motor's pinion from the main gear before proceeding with any electric governor set up.

- Make sure your ESC is configured for external governor use. Refer to the owner's manual for your ESC.
- You may use either a brushless phase sensor or the traditional governor magnetic sensor with a magnet mounted in a collar on the main shaft or in the main gear. With one magnet, set the gear ratio to 1:1.
- When choosing a brushless phase sensor, observe the input signal range of the CGY760R specified in the Governor Basic section.
- Refer to the manufacturer's documentation for your electric motor to select the correct pole count when using a brushless phase sensor. Pole count is set to 2 when using a magnetic sensor.
- Set the governor Working Mode (Wrk.Mode) to "GOV EXPERT" menu.
- Set the servo type (ServoTyp) to DG:1520.
- Make sure you correctly calibrate your ESC.
- Make sure you calibrate the governor speed ranges in the transmitter's governor menu and set the high and low limits for throttle in the Governor Basic menu.
- If a tail "kick" or "jerk" is observed when switching from one idle-up headspeed to another, INCREASE the Revolution Up and Down delays (Revo.Up Dly/Revo.Dn Dly – "GOV. EXPERT" Menu). Increase 2-5% at a time until the tail "kick" is suppressed.
- The greater the electronic speed control headroom built into the model as a function of its gearing, the more prone the tail will be to kicking with aggressive flying. Models geared for high headspeed but flown aggressively at low headspeed present the greatest challenge for the governor. The more optimally your model is geared for your chosen headspeed, the better the governor will function.
- Excessive governor gain worsens tail kick. Use as little gain as necessary for adequate headspeed control.
- If the model yaws nose left with aggressive collective input, activate and adjust the PIT→RUD F/F (feed forward) mixing. Increase in 2-5% increments. F/F mixing should ADD pitch to rudder with added positive or negative collective pitch assuming a CW main rotor direction.

Using the Remote Gain Functions (roll, pitch and yaw)

1. Some Futaba transmitters contain auxiliary gain functions for aileron, elevator and yaw. Please refer to your transmitter's instruction manual. Assign the Gyro (RUD), Gyro (AIL) and Gyro (ELE) channels within the transmitter. Within the CGY760R "S.BUS BASIC" menu → Rotor Head Gyro Gain "Gain A/E" – In the SBUS menu assigning "Gain A/E" to a channel will allow the Rotor head gain to be adjusted via the TX. If you are using a 6CH or less TX, setting "Gain A/E" to "INH" will then default the gain to "BaseGain" in the "FLT. TUNE" menu. Suggested setting and default is CH9. Tail Rotor Gain "Gain RUD" – In the SBUS menu assigning "Gain RUD" to a free TX channel will allow for the tail rotor gain to be adjusted via the TX. Suggested setting and default is CH5.
2. The gyro function within your transmitter should list all three gain channels. Adjustments can be made from within this function. The gyro function can usually be assigned to various switches or conditions to offer greater adjustability. Please refer to your transmitter's instruction manual for further details.

Setting the CGY760R gains by using endpoints or manual adjustments**⚠ WARNING**

ⓘ Verify that the gyro compensates in the correct direction for all three axes before flight. If the compensation direction is incorrect, the model will roll, flip, or pirouette uncontrollably even before it leaves the ground.

1. If your transmitter does not support the remote gain adjustment it is still possible to use spare channel on the transmitter to make the adjustments. Assign unused channel (verify that these channels are not assigned or operated by a switch or dial) within the transmitter. Set the "Gain A/E" channels in the "S.BUS.Basic" menu to the appropriate channel. Use the end point adjustment within your transmitter for these channels to make the gain adjustments and the reverse function within the transmitter to set the mode "AVCS/NOR". Conditions with the transmitter may also be used to achieve different gains based upon flight modes. Please refer to your transmitter's instruction manual for further details.

Manual gain adjustment

1. If your setup does not leave any channels free or if your transmitter does not support auxiliary gain adjustment, then it is possible to adjust the gain manually within the CGY760R. Set both the "Gain A/E" in the "SBUS. BASIC" menu to "INH". The gain adjustments are now made by entering the "BaseGain" in the "FLT. TUNE" menu and pressing the [▲/+] or [▼/-] key.

EXPERT MENU (SETUP STYLE: 3D)

This menu sets the user to further refine the gyro and governor settings. The menu changes on "Setup Style" on page 45 with "3D" and "F3C". (F3C see page 97)

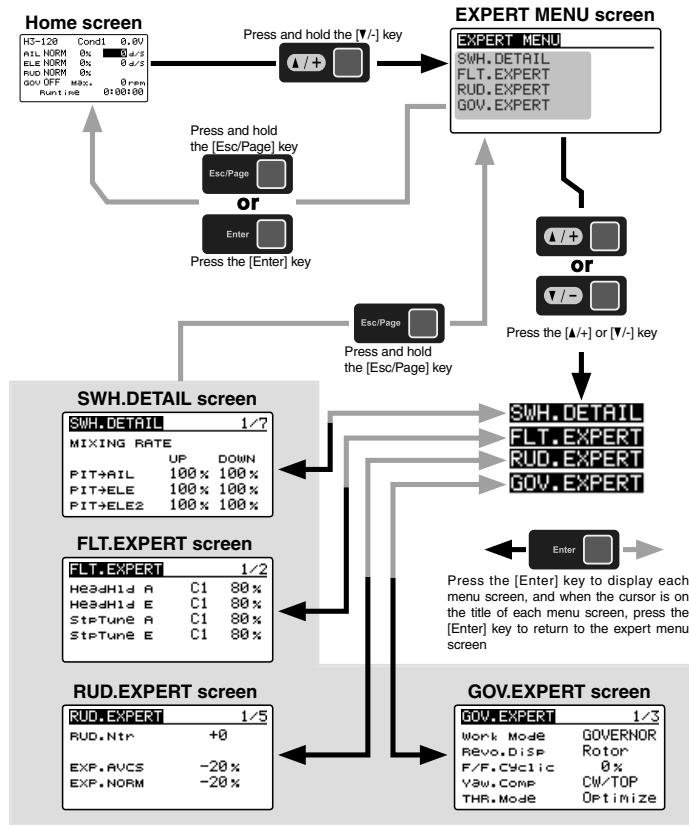

RUD. EXPERT MENU (RUDDER GYRO EXPERT SETTING)

The rudder Expert menu allows for further refinement of the tail rotor gyro performance. Refer to page 78 and display the "RUD. EXPERT" screen from the "EXPERT MENU 3D" screen.

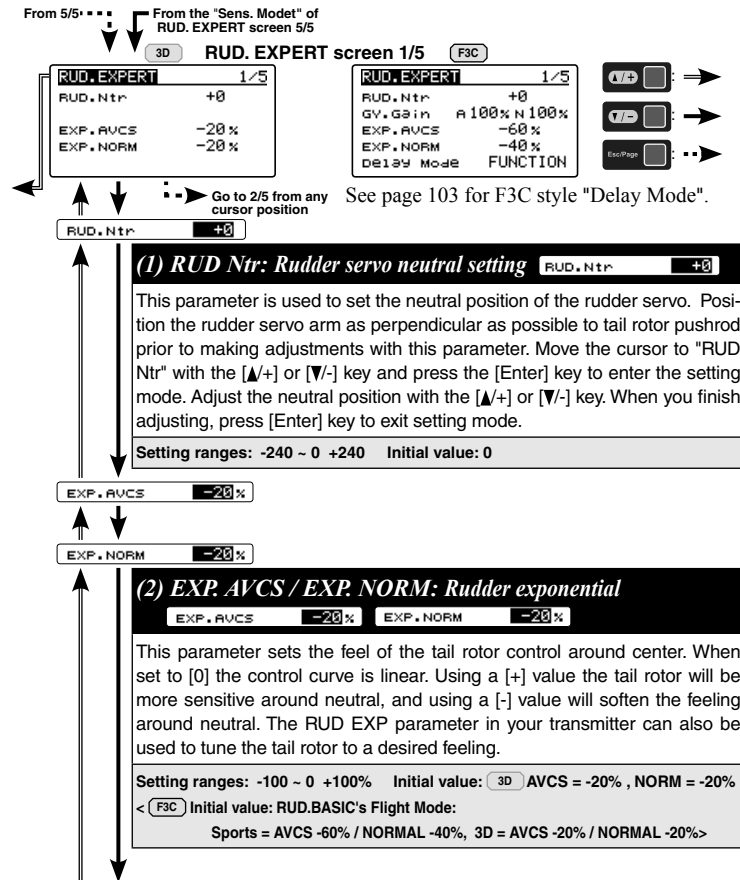

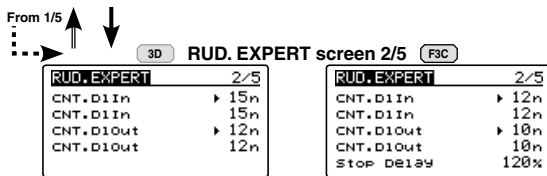

See page 103 for F3C style "Stop Delay".

Go to 3/5 from any cursor position

CNT.D1In ▶ 15n

(3) CNT.D1In: Control delay in CNT.D1In ▶ 15n

This parameter sets the delay as you move the stick from neutral toward left or right. Larger values result in a softer tail rotor feel off center. This parameter must be adjusted individually for LEFT and RIGHT tail rotor commands. Hold the cursor to "CNT.D1In" by pressing the [▲/+] or [▼/-] key. Move the rudder stick to the left or right by amount the "▶" cursor moves. Enter the setting mode by pressing the [Enter] key, djst the amount of delay with the [▲/+] or [▼/-] key, and then press the [Enter] key to exit the setting mode. Set the same way on the other side.

Setting ranges: 0 ~ 20 n Initial value: 3D = 15 n

< F3C Initial value: RUD.BASIC's Flight Mode: Sports = 12 n, 3D = 15 n >

CNT.D1Out ▶ 12n

(4) CNT.D1Out: Control delay out CNT.D1Out ▶ 12n

This parameter sets the delay when the stick is returned back to the neutral position. This parameter is useful to tune how aggressively the tail rotor stops following a pirouette. The higher the value, the softer the stop. This parameter must be adjusted individually for LEFT and RIGHT tail rotor commands. The setting method is the same as "CNT.D1In", so please refer to it.

Setting ranges: 0 ~ 20 n Initial value: 3D = 12 n

< F3C Initial value: RUD.BASIC's Flight Mode: Sports = 10 n, 3D = 12 n >

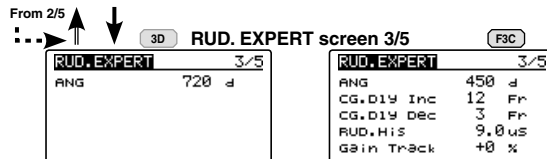

See page 103 and 104 for F3C style "CG. Dly Inc", "CG. Dly Dec", "RUD. His" and "Gain Track".

Go to 4/5 from any cursor position

ANG 720 d

(5) ANG: Pirouette speed ANG 720 d

This parameter adjusts the maximum pirouette speed of the tail rotor that the gyro will allow at 100% dual rate. Use the [▲/+] or [▼/-] key to adjust the maximum commanded pirouette rate.

Setting ranges: 100 ~ 999 d Initial value: 3D = 720 d, F3C = 450 d,

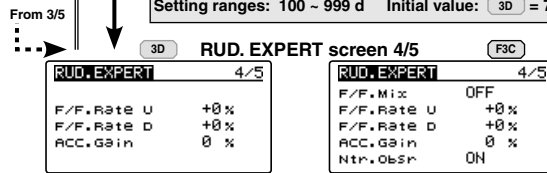

See page 104 for F3C style "F/F. Mix".

Go to 5/5 from any cursor position

F/F.Rate U +0%

F/F.Rate D +0%

(6) F/F.Rate U / F/F.Rate D: F/F mixing rate

F/F.Rate U +0% F/F.Rate D +0%

Feed Forward mix is used to counteract sudden increases in torque from the motor during fast collective pitch changes. If you notice a tail kick, using (right rudder on Clockwise rotor disk, left rudder on CCW) F/F mixing can be tuned to reduce the tail kick. Mixing amount can be individually set for high pitch side (U) and low pitch (D) side with pitch zero as the center.

Setting ranges: -100 ~ 0 ~ +100% Initial value: +0%

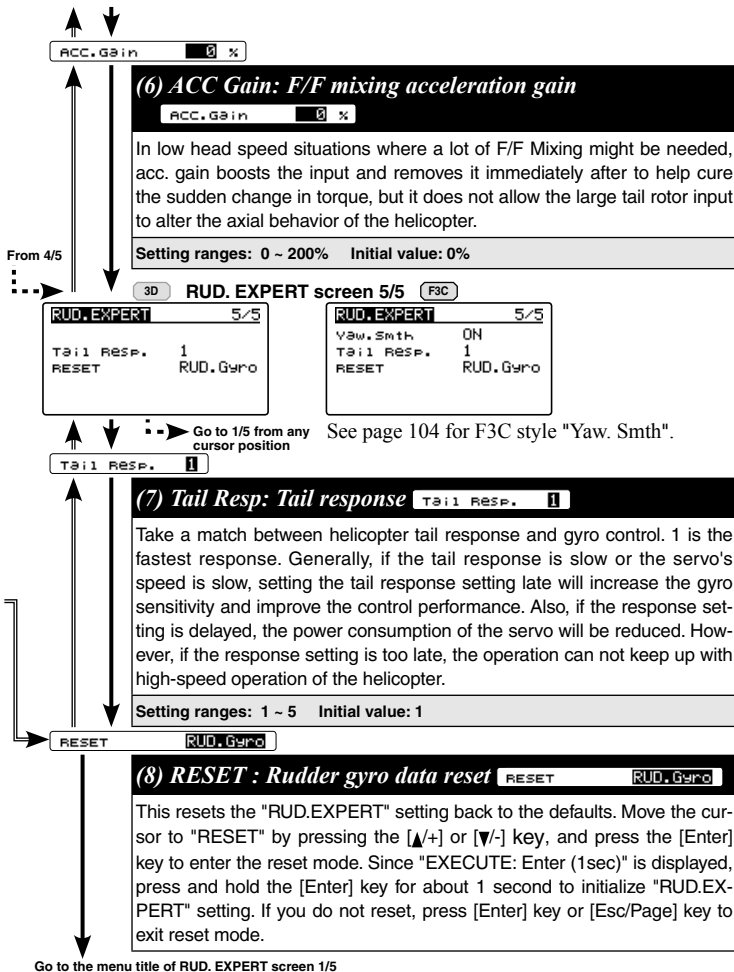

FLT. EXPERT MENU (CYCLIC GYRO EXPERT SETTING)

The "FLT.EXPERT" menus allow further refinement of cyclic gyro performance. Refer to page 78 and display the "FLT. EXPERT" screen from the "EXPERT MENU 3D" screen.

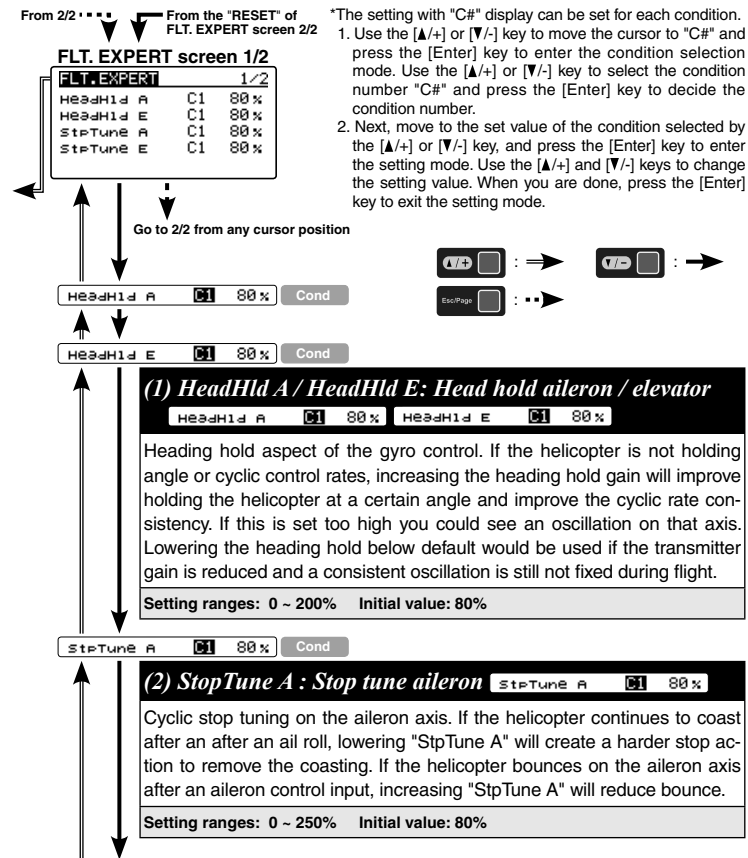

StpTune E Cond

(3) StopTune E: Stop tune elevator StpTune E

Cyclic stop tuning on the elevator axis. If the helicopter after an elevator flip continues to coast, lowering "StopTune E" will create a harder stop action to remove the coasting. If the helicopter continues to coast after an elevator flip, lowering the "Stop tune E" will reduce bounce.

Setting ranges: 0 - 250% Initial value: 80%

FLT. EXPERT screen 2/2

FLT. EXPERT 2/2

HeadResp	1
DeadBand	4.0
RESET	FLT. Tun

Go to 1/2 from any cursor position

HeadResp

(4) HeadResp: Head Response HeadResp

Head Response matches the gyro control speed to that which the helicopter is capable of reacting. In a standard helicopter a Head Response of 1 should always be used, but on some scale applications, or uniquely designed rotor heads, increasing head response might be needed to cure over correction of the gyro.

Setting ranges: 1 - 10 Initial value: 1

DeadBand

(5) DeadBand: Dead band DeadBand

Transmitter control dead band. If you are noticing inconsistent swash plate drift or poor initialization it could be poor TX potentiometer resolution. If you have to increase past 10.0 it is best to check calibration on your TX.

Setting ranges: 0 - 25 Initial value: 4.0

RESET

(6) RESET : FLT tune data reset RESET

This resets the "FLT.Tun" setting back to the defaults. Move the cursor to "RESET" by pressing the [▲/+] or [▼/-] key, and press the [Enter] key to enter the reset mode. Since "EXECUTE: Enter (1sec)" is displayed, press and hold the [Enter] key for about 1 second to initialize "FLT.Tun" setting. If you do not reset, press [Enter] key or [Esc/Page] key to exit reset mode.

Go to the menu title of FLT. EXPERT screen 1/2

SWH. DETAIL MENU (SWASH DETAIL SETTING)

The swash detail setting is used to keep the swash plate level at high and low collective pitch to cyclic interactions and cyclic pitch to collective pitch interactions. Refer to page 78 and display the "SWH. DETAIL" screen from the "EXPERT MENU 3D" screen.

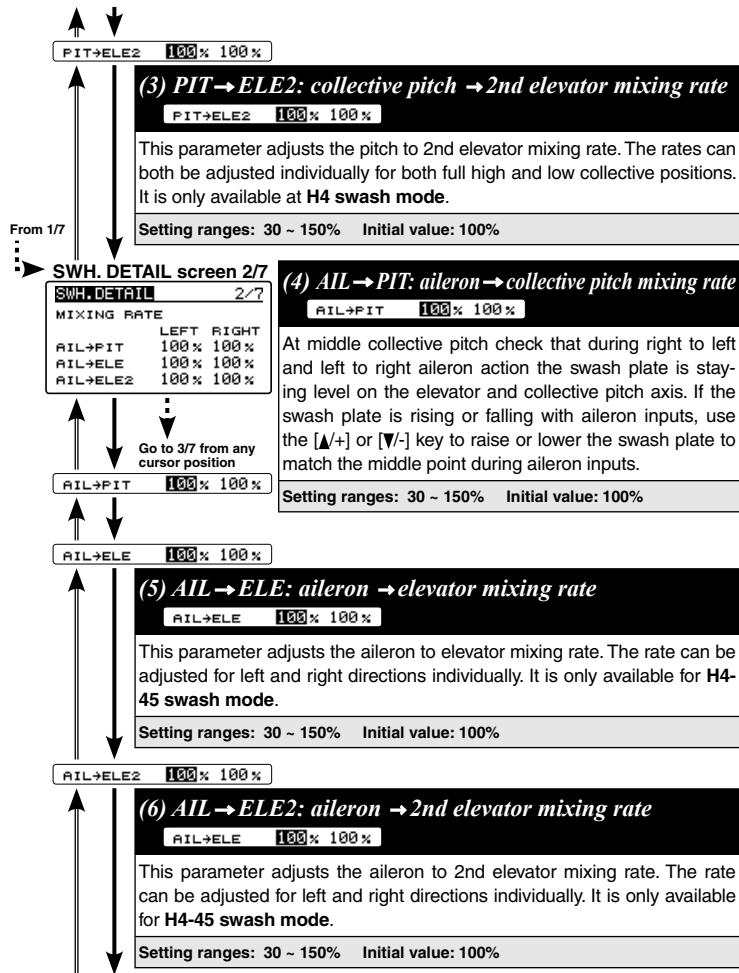
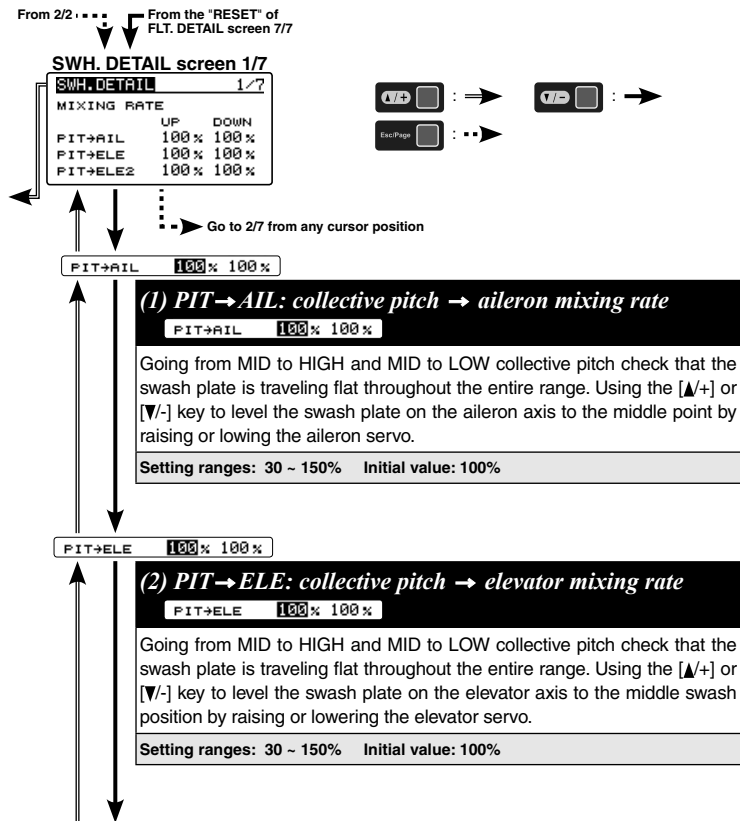

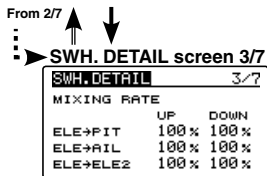

Go to 4/7 from any cursor position

ELE→PIT 100 % 100 %

(7) ELE→PIT: elevator→collective pitch mixing rate

AIL→PIT 100 % 100 %

During back and forward elevator inputs at middle collective, check if the swash plate is raising or lowering during the input. If it is moving use the [▲/+] or [▼/-] key to raise or lower the swash plate to match the middle point during elevator inputs.

Setting ranges: 30 ~ 150% Initial value: H3-120 = 50%, except H3-120 = 100%

ELE→AIL 100 % 100 %

(8) ELE→AIL: elevator→aileron mixing rate

AIL→PIT 100 % 100 %

While moving the elevator back and forth at middle collective, check to make sure the aileron axis is staying level. Use the [▲/+] or [▼/-] key to raise or lower to level the swash plate during full forward and back elevator input.

Setting ranges: 30 ~ 150% Initial value: H3-120 = 50%, except H3-120 = 100%

ELE→ELE2 100 % 100 %

(9) ELE→ELE2: elevator →2nd elevator mixing rate

ELE→ELE2 100 % 100 %

This parameter adjusts the elevator to 2nd elevator mixing rate. The rate can be adjusted for up and down directions individually. It is only available for H4 swash mode.

Setting ranges: 30 ~ 150% Initial value: 100%

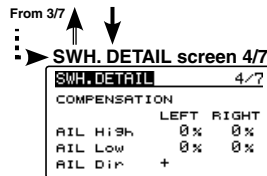

Go to 5/7 from any cursor position

AIL High 0 % 0 %

AIL Low 0 % 0 %

(10) AIL High / AIL Low: Linkage compensation aileron

AIL High 0 % 0 % AIL Low 0 % 0 %

At HIGH pitch and LOW pitch check to make sure that the swash plate is staying level on the elevator and collective axis when using aileron inputs. If the swash plate is raising or falling, use the [▲/+] or [▼/-] key to keep the swash plate position the same as middle during aileron inputs.

NOTE: check all four directions: high/right; high/left; low/right; low/left

Setting ranges: 0 ~ 100% Initial value: 0%

AIL Dir +

(11) AIL Dir: Compensation direction of the aileron

AIL Dir +

If the above Data (+/-) correction from 0-100 is NOT in the correct compensation direction, change the value from [+] or [-] using the [▲/+] or [▼/-] key.

Setting: +/- Initial setting: +

From 4/7
 SWH.DETAIL screen 5/7

SWH.DETAIL 5/7		
COMPENSATION		
	DOWN	UP
ELE High	0%	0%
ELE Low	0%	0%
ELE Dir	+	

ELE High 0% 0%

ELE Low 0% 0%

(12) ELE High / ELE Low: Linkage compensation elevator

ELE High 0% 0% ELE Low 0% 0%

At HIGH pitch and LOW pitch check to make sure that the swash plate is staying level on the aileron and collective axis when using elevator inputs. If the swash plate is raising or falling, use the [▲/+] or [▼/-] key to keep the swash plate position the same as middle during elevator inputs.

NOTE: check all four directions: high/back; high/forward; low/back; low/forward.

Setting ranges: 0 ~ 100% Initial value: 0%

ELE Dir +

(13) ELE Dir: Compensation direction of the elevator

ELE Dir +

If the above Data (+/-) correction from 0-100 is NOT in the correct compensation direction, change the value from [+] or [-] using the [▲/+] or [▼/-] key.

Setting: +/- Initial setting: +

From 5/7
 SWH.DETAIL screen 6/7

SWH.DETAIL 6/7	
Speed Comp	0%
SWASH Rot	+0 DEG.

SWH.DETAIL 6/7	
Speed Comp	0%
SWASH Rot	+0 DEG.
ROT. Trak	+0.0%
PHASE Equ	OFF
PIT COMP	ON

See page 105 for F3C style "ROT. Trak", "Phase Equ" and "PIT Comp".

Speed Comp 0%

(14) Speed Comp: Speed compensation

Speed Comp 0%

In 120 degree CCPM all servos do not travel the same distance on elevator input. Having previously set the ELE-PIT and ELE-AIL parameters, if during FAST movement of the elevator axis the swash plate is not staying level, use the [▲/+] or [▼/-] key to match all servo speeds (+ will slow the Aileron/Pitch Servo – will reduce speed comp on Aileron/Pitch Servo)

Setting ranges: 0 ~ 100% Initial value: H3-120 = 50%, except H3-120 = 0%

SWASH Rot +0 DEG.

(15) SWASH Rot: Swash rotation

SWASH Rot +0 DEG.

Using the [▲/+] or [▼/-] key electronically add rotor head phasing to the swash plate controls. If possible, it is recommended to use mechanical phasing adjustment, but if the rotor head does not allow this and you feel that the model is NOT flying axially on each control input, using this parameter can be used to adjust the pure reaction of each axis in flight. (Typically advanced phasing on clockwise rotor disk and a slight clockwise increase in swash plate alignment vs rotor axle are needed to create a axial reaction, vice versa for a counterclockwise rotor disk model.)

Setting ranges: -90 deg ~ +90 deg Initial value: +0 deg

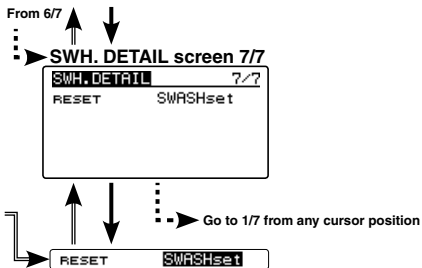

(16) RESET : Swash detail data reset RESET SWASHset

This resets the "SWH.DETAIL" setting back to the defaults. Move the cursor to "RESET" by pressing the [▲/+] or [▼/-] key, and press the [Enter] key to enter the reset mode. Since "EXECUTE: Enter (1sec)" is displayed, press and hold the [Enter] key for about 1 second to initialize "SWH.DETAIL" setting. If you do not reset, press [Enter] key or [Esc/Page] key to exit reset mode.

Go to the menu title of SWH.DETAIL screen 1/7

GOV. EXPERT MENU (GOVERNOR EXPERT SETTING)

This menu sets the Governor Expert allows the user to further refine the governor settings. Refer to page 78 and display the "GOV EXPERT" screen from the "EXPERT MENU 3D" screen.

From 3/3 ... From the "RESET" of GOV. EXPERT screen 3/3

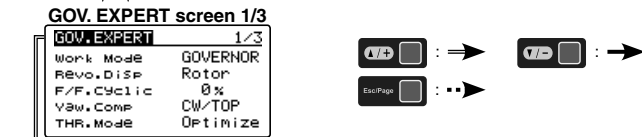

Go to 2/3 from any cursor position

Work Mode GOVERNOR

(1) Work Mode: Governor working mode Work Mode GOVERNOR

Sets the governing type mode.

- **GOVERNOR** (Governor Mode) – RPM is entirely controlled by the GOV once it has engaged. The GOV will do whatever it takes to hold a constant RPM throughout flight.
- **Rev. Lmt** (Limiter Mode) – Throttle control follows the throttle curves to advance the throttle position during flight, but controls the RPM during throttle reduction by not letting the RPM over speed past the set RPM.

Setting: GOVERNOR / Rev. Lmt Initial setting: GOVERNOR

Revo. Disp Rotor

(2) Revo Disp: Governor working mode Revo. Disp Rotor

Ability to choose to display desired Rotor RPM or Engine RPM.

Setting: Rotor / Engine Initial setting: Rotor

F/F. Cyclic 0%

(3) F/F. Cyclic: Feed Forward from Cyclic

F/F. Cyclic 0%

Increasing the value will add throttle with cyclic commands to aid in RPM stability.

Setting ranges: 0 ~ 100% Initial value: 0%

V3w. Comp CW/TOP

(4) Yaw. Comp: Governor working mode V3w. Comp CW/TOP

Yaw compensation allows the governor to more rapidly correct for changes in power demands of the model resulting from yaw input. Set the mode to match the gyro installing direction, either CW/TOP, CW/BOTM, CCW/TOP, CCW/BOTM by pressing the [▲/+] or [▼/-] key. At the governor only mode, this parameter is inhibited.

Revolution fluctuation in the case of pirouettes

The governor detects the rpm by the revolution sensor mounted in the engine section. At the time of the pirouettes, the helicopter itself rotates, so that its pirouettes speed is added (reduced) to the engine speed. Therefore, the main rotor speed of the ground will fluctuate. Since the CGY 760R has a gyro, it can accurately measure the pirouettes speed. The yaw rate correction is realized by a combination of gyro function and governor function.

CW: clockwise rotor direction
CCW: counter clockwise rotor direction
TOP: Gyro top/name emblem facing up
BOTM: Gyro top/name emblem facing down

Setting: CW/TOP, CW/BOTM, CCW/TOP, CCW/BOTM Initial setting: CW/TOP

THR. Mode Optimize

(5) THR. Mode: Throttle data mode THR. Mode Optimize

This parameter selects the throttle input operation. pressing the [▲/+] or [▼/-] key, the mode is changed.

Optimize:
 CGY760R sets the throttle input signal to optimum. There is no need to consider the throttle curve setting on the transmitter.

Fixed:
 The fixed throttle input is utilized related to the revolution. It is recommended for electric motors.

Tx.Curve:
 CGY760R uses the exact throttle input from the transmitter. The throttle curve setting on the transmitter is required. When the Rev.Lmt mode is selected, this mode should be selected.

Setting: GOVERNOR / Rev. Lmt Initial setting: GOVERNOR

From 1/3

GOV. EXPERT screen 2/3

GOV. EXPERT	2/3
Revo. Up Dly	8 Frm
Revo. Dn Dly	10 Frm
Start Dly	5 Frm
Gov. On. Revo	60 %
BFS. Volt	3.8 v

Go to 3/3 from any cursor position

Revo. Up Dly 8 Frm

Revo. Dn Dly 10 Frm

(6) Revo. Up Dly: Revolution change up delay Revo. Up Dly 8 Frm

How quickly the RPM changes when increasing RPM between two different RPM conditions and flight modes. A higher number slows the RPM change rate; a lower value speeds up the RPM change rate.

Setting ranges: 2 ~ 40 Frm Initial value: 8 Frm

Revo. Dn Dly 10 Frm

(7) Revo. Dn Dly: Revolution change down delay Revo. Dn Dly 10 Frm

How quickly the RPM changes when reducing RPM between two different RPM conditions and flight modes. A higher number slows the RPM change rate; a lower value speeds up the RPM change rate.

Setting ranges: 2 ~ 40 Frm Initial value: 10 Frm

Start Dly 5 Frm

(8) Start Dly: Start delay Start Dly 5 Frm

How quickly the RPM stabilizes to the set RPM from when the GOV is turned ON. A higher value slows down the spool up rate; a lower value speeds up the spool up rate.

Setting ranges: 2 ~ 20 Frm Initial value: 5 Frm

Gov. On. Revo 60 %

(9) Gov. On. Revo: Governor ON revolution setting Gov. On. Revo 60 %

This parameter tells the governor at what percentage of the set rpm it is to become active. The default value is 60 %. In this case, the governor will not engage until the engine rpm reaches 60 % of the set rpm. If you feel that the time for governor engagement is too slow, decrease the value to 50 ~ 55%. The starting time will be faster.

Setting ranges: 50 ~ 90% Initial value: 60%

↑ ↓

BFS.Volt 3.8 v

(10) BFS. Volt: Battery F/S voltage setting BFS.Volt 3.8 v

This parameter sets the battery fail safe and low battery alarm voltage. Set the proper voltage by the battery type. The battery characteristics are different depending on cell type/chemistry. The voltage setting is changed by pushing the [▲/+] or [▼/-] key. Suggested setting voltages are as follows.

- 4 cells NiCd or NiMH (Normal: 4.8v) = 3.8 v
- 2 cells LiFe (Normal: 6.6 v) = 6.0 ~ 6.2 v
- 2 cells LiPo (Normal: 7.4 v) = 7.2 ~ 7.4 v

From 2/3

GOV. EXPERT screen 3/3

GOV. EXPERT 3/3

Low. Revo 1000rpm

RESET Governor

↑ ↓

Low. Revo 1000rpm

(11) Low. Revo: Low revolution setting Low. Revo 1000rpm

This value is set to assign the lowest possible governing RPM. If the RPM is set below, or cannot reach this RPM, the governor will not engage. Select 1,000 rpm or 700 rpm. It corresponds also to a helicopter with a rotor speed of 1,000 rpm or less such as a large gas power machine.

Setting: 700 / 1,000 rpm Initial setting: 1000 rpm

↑ ↓

RESET Governor

(12) RESET : Governor expert data reset RESET Governor

This resets the "GOV. EXPERT" setting back to the defaults. Move the cursor to "RESET" by pressing the [▲/+] or [▼/-] key, and press the [Enter] key to enter the reset mode. Since "EXECUTE: Enter (1sec)" is displayed, press and hold the [Enter] key for about 1 second to initialize "GOV. EXPERT" setting. If you do not reset, press [Enter] key or [Esc/Page] key to exit reset mode.

Go to the menu title of GOV. EXPERT screen 1/3

EXPERT MENU (SETUP STYLE: F3C)

It is a menu which makes detailed setting of each gyro and governor of CGY760R. Set as required. The menu changes on "Setup Style" on page 45 with "3D" and "F3C". (3D see page 78) The "FLT. EXPERT" of "3D" separates into "AIL EXPERT" and "ELE EXPERT" and the function setting will be detailed. From here, it explains "AIL EXPERT" and "ELE EXPERT". For other expert menu, please refer to "EXPERT MENU 3D" and "F3C SPECIAL EXPERT SECTION" described after this.

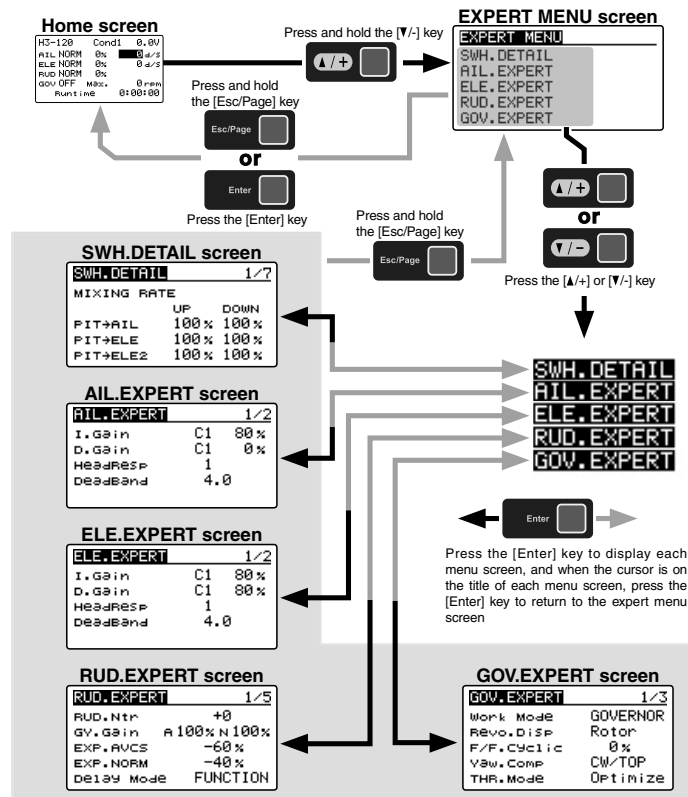

AIL. EXPERT MENU (AILERON EXPERT SETTING)

The "AIL.EXPERT" menus allow further refine the aileron performance of the cyclic gyro. Refer to page 97 and display the "AIL.EXPERT" screen from the "EXPERT MENU F3C" screen.

From 2/2 ... From the "RESET" of AIL. EXPERT screen 2/2

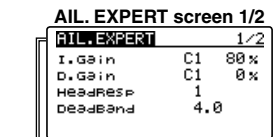

Go to 2/2 from any cursor position

*The setting with "C#" display can be set for each condition.

1. Use the [▲/+] or [▼/-] key to move the cursor to "C#" and press the [Enter] key to enter the condition selection mode. Use the [▲/+] or [▼/-] key to select the condition number "C#" and press the [Enter] key to decide the condition number.
2. Next, move to the set value of the condition selected by the [▲/+] or [▼/-] key, and press the [Enter] key to enter the setting mode. Use the [▲/+] and [▼/-] keys to change the setting value. When you are done, press the [Enter] key to exit the setting mode.



I.Gain C1 80%

(1) I.Gain : Integral gain I.Gain C1 80%

I gain tunes the ability of the model to maintain a given heading. Inadequate I gain results in a change in model heading especially with aggressive collective pitch input. Excessive I gain can result in oscillations in forward flight or with cyclic input. Use the [▲/+] or [▼/-] key to make an adjustment.

Setting ranges: 0 ~ 200% Initial value: 80%

D.Gain C1 0%

(2) D.Gain : Derivative gain D.Gain C1 0%

I gain tunes the ability of the model to maintain a given heading. Inadequate I gain results in a change in model heading especially with aggressive collective pitch input. Excessive I gain can result in oscillations in forward flight or with cyclic input. Use the [▲/+] or [▼/-] key to make an adjustment.

Setting ranges: 0 ~ 250% Initial value: 0%

HeadResp 1

(3) HeadResp : Head Response HeadResp 1

Head Response matches the gyro control speed to that which the helicopter is capable of reacting. In a standard helicopter a Head Response of 1 should always be used, but on some scale applications, or uniquely designed rotor heads, increasing head response might be needed to cure over correction of the gyro.

Setting ranges: 1 ~ 10 Initial value: 1

DeadBand 4.0

(4) DeadBand: Dead band DeadBand 4.0

Transmitter aileron control dead band. Use the [▲/+] or [▼/-] key to make an adjustment. If you are noticing inconsistent swash plate drift or poor initialization it could be poor TX potentiometer resolution. If you have to increase past 10.0 it is best to check calibration on your TX.

Setting ranges: 0 ~ 25 Initial value: 4.0

From 1/2

AIL. EXPERT screen 2/2



Go to 1/2 from any cursor position

AIL. Comp U 0%

AIL. Comp D 0%

(5) AIL.Comp U/D: Aileron compensation

AIL. Comp U 0% AIL. Comp D 0%

This parameter sets the mixing rate of the pitch to aileron mixing. The roll axis may be affected by positive/negative collective pitch movement as manifested by the model rolling off either to the left or to the right during rapid ascent or descent. This mixing compensates this effect. The mixing amount can be adjusted individually for both positive and negative collective pitch inputs.

Setting ranges: 0 ~ 100% Initial value: 0%

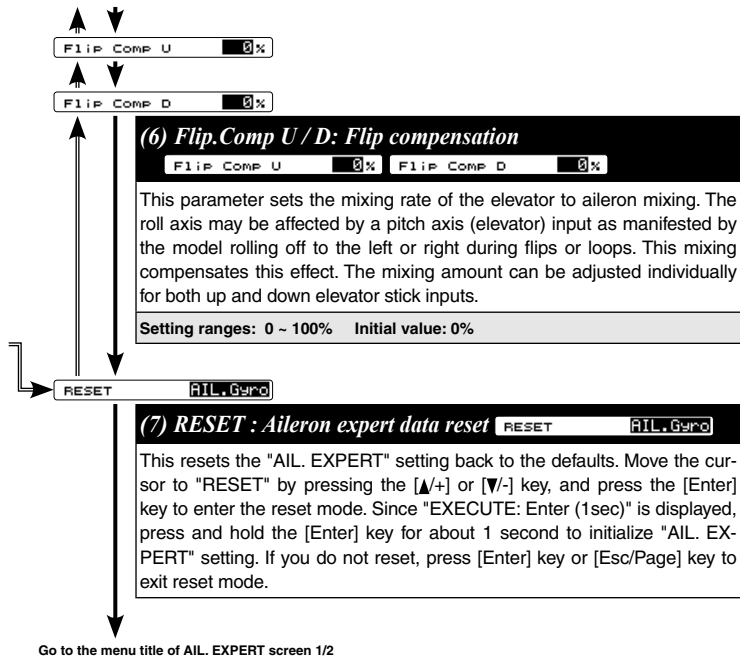

Go to the menu title of AIL. EXPERT screen 1/2

ELE. EXPERT MENU (ELEVATOR EXPERT SETTING)

The "ELE.EXPERT" menus allow further refine the elevator performance of the cyclic gyro. Refer to page 97 and display the "ELE.EXPERT" screen from the "EXPERT MENU F3C" screen.

From 2/2 ... From the "RESET" of ELE. EXPERT screen 2/2

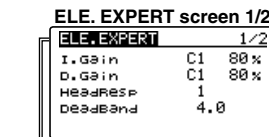

*The setting with "C#" display can be set for each condition.

1. Use the [▲/+] or [▼/-] key to move the cursor to "C#" and press the [Enter] key to enter the condition selection mode. Use the [▲/+] or [▼/-] key to select the condition number "C#" and press the [Enter] key to decide the condition number.
2. Next, move to the set value of the condition selected by the [▲/+] or [▼/-] key, and press the [Enter] key to enter the setting mode. Use the [▲/+] and [▼/-] keys to change the setting value. When you are done, press the [Enter] key to exit the setting mode.

Go to 2/2 from any cursor position



I.Gain C1 80%

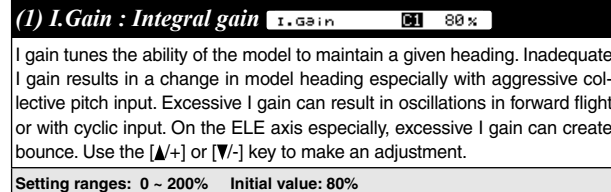

D.Gain C1 80%

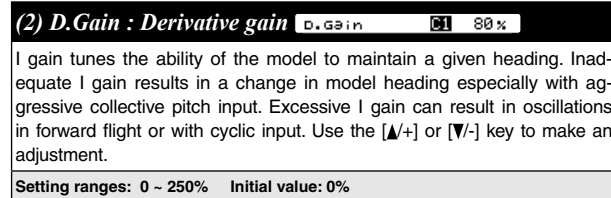



The following settings are displayed in "EXPERT MENU" when "Setup Style" of page 45 is "F3C".

RUD. EXPERT MENU

RUD. EXPERT screen 1/5

Delay Mode **FUNCTION** **F3C**

Delay Mode: Rudder gyro gain setting Delay Mode **FUNCTION**

Select "FUNCTION" for a softer control feel and "CONSTANT" for a linear and aggressive feel.

Setting: **FUNCTION / CONSTANT** Initial Setting: **FUNCTION**

RUD. EXPERT screen 2/5

Stop Delay **120%** **F3C**

Stop Delay: Rudder gyro gain setting Stop Delay **120%**

This parameter may also be used to adjust the aggressiveness of the stop but is individually NOT tuneable for LEFT versus RIGHT tail rotor commands. Larger values will soften the tail stops resulting in less bounce.

Setting ranges: 100 ~ 400% Initial value: 120%

RUD. EXPERT screen 3/5

CG. Dey Inc **12** Fr **F3C**

CG. Dey Inc: Gain change up delay CG. Dey Inc **12** Fr

This parameter sets the delay of change of the gyro gain from low to high when switching from idle up to hover and helps avoid the chance for tail rotor hunting during this switch.

Setting ranges: 1 ~ 50 Fr Initial value: 12 Fr

CG. Dey Dec **3** Fr **F3C**

CG. Dey Dec: Gain change down delay CG. Dey Dec **3** Fr

This sets the delay of the gyro gain from high to low as would occur during a switch from hover into idle up and helps prevent the tail from feeling "loose" while the head speed accelerates to the higher rate.

Setting ranges: 1 ~ 50 Fr Initial value: 3 Fr

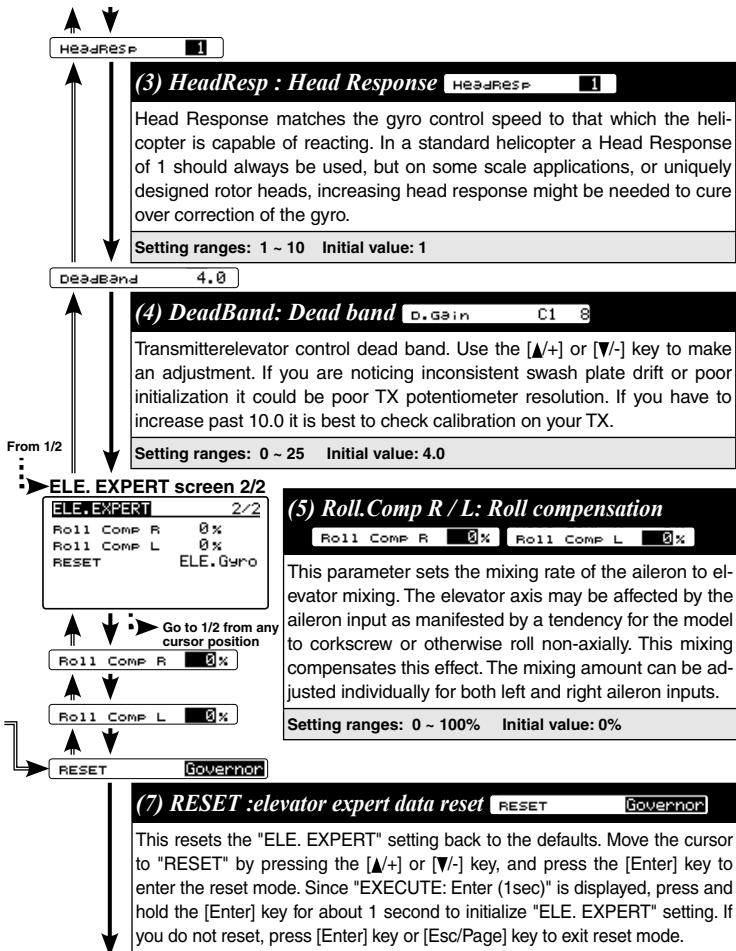

Go to the menu title of AIL. EXPERT screen 1/2

RUD.His 9.0 μs F3C

RUD. His: Rudder histeresis CG.Dly Dec 3 Fr

Hysteresis adjusts the range right around center of tail rotor stick travel within which a tail rotor input will result in no rudder servo movement. The greater the value, the wider the range where stick movement yields no servo movement.

Setting ranges: 0 ~ 50 μs Initial value: 9.0 μs

Gain Track +0 % F3C

Gain Track: Gain tracking Gain Track +0 %

Gain tracking is another method to adjust how the tail rotor stops. For example, when there is a bounce when stopping a left pirouette or the helicopter coasts when stopping right pirouette, increase gain tracking in the + direction. In the opposite situation, shift the gain tracking in the - direction.

Setting ranges: -20 ~ 0 ~ -20% Initial value: +10%

RUD. EXPERT screen 4/5

F/F.Mix OFF F3C

F/F. Mix: F/F mixing F/F.Mix OFF

Feed Forward mixing is activated with this parameter. F/F mixing is a pitch to rudder mix applied outside of the gyro compensation's control loop and before the gyro itself can even sense undesired tail rotor movement. F/F mixing is handled within the CGY760R. Do not attempt to use revolution or acceleration mixing within your transmitter as this will actually adjust the input signal to the gyro and cause drifting.

Setting: ACTIVE / OFF Initial Setting: OFF

RUD. EXPERT screen 5/5

Yaw.Smth ON F3C

Yaw. Smth: Yaw smoother Yaw.Smth ON

This parameter selects the rudder control feeling. When turned on, rudder control becomes more exact. When turned off, rudder control authority increases. Select the rudder control feeling to your taste.

Setting: ON / OFF Initial Setting: ON

SWH. DETAIL MENU

SWH. DETAIL screen 6/7

ROT.Trak +0.0% F3C

ROT. Trak: Rotational tracking ROT.Trak +0.0%

This parameter tunes the rotational equalizer to the pirouette characteristics of the model. When pirouetting the model at the desired rate, observe the model's rotor DISK (NOT the mechanics) and tune the ROT.Trak until the disk stays flat during the pirouette. Find the best average setting for both left and right pirouettes.

Setting ranges: -5.0 ~ 0 ~ 5.0% Initial value: +0.0%

Phase Equ OFF F3C

Phase. Equ: Phase equalizer Phase Equ OFF

This parameter optimizes swashplate phasing during pirouettes. Press the [▲/+] or [▼/-] key to turn the function on or off.

NOTE: This parameter needs rotor head RPM and direction of rotation to work correctly, so please set the rotor head RPM and direction in the governor menu. NOTE that rotor head speed information must still be set into the CGY760R governor menu even if using an electronic speed control (ESC) with an electric model.

Setting: ON / OFF Initial setting: OFF

Phase Equ OFF F3C

PIT. Comp: Pitch Compensation Phase Equ OFF

This parameter works to hold the nose and the angle that the helicopter is set at regardless of collective pitch movements and direction changes. Press the [▲/+] or [▼/-] key to turn the function on or off.

Setting: ON / OFF Initial setting: ON

Via Trainer	1/9
<AIL/ELE>	
CYC.Rt	C1 300 d/s
Cnt.AuthAIL	C1 40%
Cnt.AuthELE	C1 40%

-FLT. TUNE

CYC. Rt: Cyclic rate setting (page 57)
 Cnt. AuthAIL: Control Authority Aileron (page 58)
 Cnt. AuthELE: Control Authority Elevator (page 58)

Via Trainer	2/9
<AIL/ELE>	
EXPO.	C1 -20%
FLT.Styl	C1 +50%

EXPO.: Exponential (page59)
 FLT. Styl: Flight style (page59)

Via Trainer	3/9
<SWASH>	
SWS.Rate	C1 50%
PIT.Rate	C1 50%
SWS.Ring	C1 130%

-SWH. BASIC

SWS. Rate: Rate adjustment (page 48)
 PIT. Rate: Rate adjustment (page 49)
 SWS. Ring (page 49)

Via Trainer	4/9
<GOVERNOR>	
GOV.Gain	C1 40%
L Lmt.L RPM	C1 25%
L Lmt.H RPM	C1 45%

- GOV. BASIC

GOV Gain: Governor gain (page 71)
 L Lmt. Hov : Low limit hovering RPM (page 71)
 L Lmt. Idle : Low limit idling RPM (page 71)

Via Trainer	5/9
<FLT>	
HeadHld A	C1 80%
StopTune A	C1 80%
HeadRESP	1

-FLT. EXPERT

HeadHld A : Head hold aileron (page 83)
 StopTune A : Stop tune aileron (page 83)
 HeadResp: Head Response (page 84)

Via Trainer	6/9
<FLT>	
HeadHld E	C1 80%
StopTune E	C1 80%

HeadHld E: Head hold elevator (page 83)
 StopTune E : Stop tune elevator (page 83)

Via Trainer	7/9
<RUD>	
EXP.AVCS	-20%
EXP.NORM	-20%

-RUD. EXPERT

EXP. AVCS: Rudder exponential AVCS (page 79)
 EXP. NORM: Rudder exponential NORMAL (page 79)

Via Trainer	8/9
<RUD>	
CNT.DlIn	15n
CNT.DlOut	15n
CNT.DlOut	12n
CNT.DlOut	12n

CNT. DlIn: Control delay in (page 80)
 CNT. DIOut: Control delay out (page 80)

Via Trainer	9/9
<RUD>	
ANG	720 d
Tail Resp.	1

ANG: Pirouette speed (page 81)
 Tail Resp: Tail response (page 82)

Via Trainer	1/9
<AIL/ELE>	
CYC.Rt	C1 300 d/s
Cnt.GnAIL	C1 32%
Cnt.GnELE	C1 36%

-FLT. TUNE

CYC. Rt: Cyclic rate setting (page 57)
 Cnt. GnAIL: Control Gain Aileron (page 58)
 Cnt. GnELE: Control Gain Elevator (page 58)

Via Trainer	2/9
<AIL/ELE>	
EXPO.	C1 -20%
RESP.Styl	C1 +12%
Stab.Gn	C1 5

EXPO.: Exponential (page59)
 FLT. Styl: Flight style (page59)
 Stab. Gn: Stability gain (page61)

Via Trainer	3/9
<SWASH>	
SWS.Rate	C1 50%
PIT.Rate	C1 50%
SWS.Ring	C1 130%

-SWH. BASIC

SWS. Rate: Rate adjustment (page 48)
 PIT. Rate: Rate adjustment (page 49)
 SWS. Ring (page 49)

Via Trainer	4/9
<GOVERNOR>	
GOV.Gain	C1 40%
L Lmt.Hov	C1 25%
L Lmt.Idle	C1 45%

- GOV. BASIC

GOV Gain: Governor gain (page 71)
 L Lmt. Hov : Low limit hovering RPM (page 71)
 L Lmt. Idle : Low limit idling RPM (page 71)

Via Trainer	5/9
<AIL>	
I.Gain	C1 80%
D.Gain	C1 0%
HeadRESP	1

-AIL. EXPERT

I.Gain : Integral gain (page 98)
 D.Gain : Derivative gain (page 98)
 HeadResp: Head Response (page 99)

Via Trainer	6/9
<ELE>	
I.Gain	C1 80%
D.Gain	C1 80%
HeadRESP	1

-ELE. EXPERT

I.Gain : Integral gain (page 101)
 D.Gain : Derivative gain (page 101)
 HeadResp: Head Response (page 102)

Via Trainer	7/9
<RUD>	
EXP.AVCS	-60%
EXP.NORM	-40%

-RUD. EXPERT

EXP. AVCS: Rudder exponential AVCS (page 79)
 EXP. NORM: Rudder exponential NORMAL (page 79)

Via Trainer	8/9
<RUD>	
CNT.DlIn	12n
CNT.DlIn	12n
CNT.DlOut	10n
CNT.DlOut	10n

CNT. DlIn: Control delay in (page 80)
 CNT. DIOut: Control delay out (page 80)

Via Trainer	9/9
<RUD>	
Stop Delay	120 %
ANG	450 d
Tail Resp.	1

Stop Delay: Rudder gyro gain setting (page 103)
 ANG: Pirouette speed (page 81)
 Tail Resp: Tail response (page 82)

WARNING

❗ When installing with screws, take countermeasures against vibration damping of the machine and make the state with less vibration.

*Please do not mounting with machine screws with vibration, please mounting with a dedicated mounting pad.

Drill holes in the plate

Refer to the figure below and drill holes to attach to the plate.

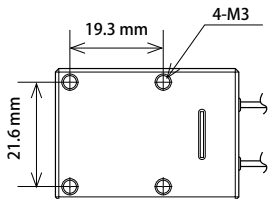

Screw size for fixing

The effective length of the fixing screw hole of the CGY760R main unit is 7mm.

Use the M3 screw whose length is less than the plate thickness plus 7mm.

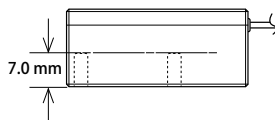

Mounting

Fix it with M3 screw from the bottom of the plate as shown on the right. Please refer to the above explanation for the length.

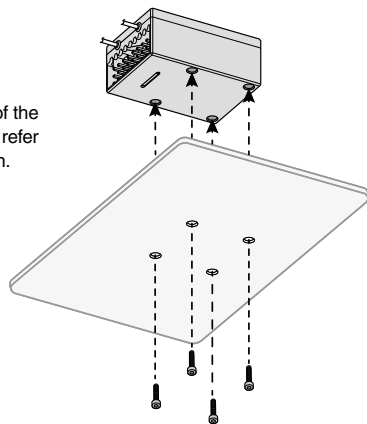

NOTE:

*Please take measures to prevent looseness so that the screw does not become loose during flight.

*CGY 760R main body Since the case is made of aluminum, be careful not to over-tighten the screw.

CGY760R

Control System: Digital advanced control

Angular Velocity Range: $\pm 1,000$ Degrees Per Second (Gyro)

Sensor: Micro Electromechanical Systems (MEMS) Gyro
Hall effect sensor

Governor Resolution: 0.1Hz (6rpm) (Engine RPM)

RPM Accuracy: 1%

Head Speed Range: 700-4,000rpm

Selectable Servo Frame: 70Hz, 280Hz and 560Hz (Rudder Gyro only) Rate

Center Pulse Width: 1520 μ s (70Hz & 280Hz) 760 μ s (560Hz)

Receiving system: FASSTest-2.4GHz (18CH/12CH mode)/T-FHSS-2.4GHz
S.BUS2 / S.BUS Port and 6 Channels for Conventional System

Antenna: Dual antenna diversity

Rated voltage: 3.7V to 7.4V DC* (Operating Voltage:3.5V to 8.4V)

Current Drain: 85mA (When receiving, no servo, no RPM sensor)

Operating Temperature: 14°F to 113°F (-10°C to +45°C)

Size (CGY760R): 1.055in [26.8mm](W)/1.476in [37.5mm](L)/0.63in [16mm](H)

Size (Revolution sensor): 0.827in [21mm](W)/0.63in [16mm](L)/0.39in [10mm](H)

Weight (CGY760R): 0.713oz [20.2g]

Weight(RPM sensor): 0.141oz [4g]

*The operating voltage shown only applies to the CGY760R and GBP-1. Always verify that your receiver, servos, tail rotor servo, switch and any other electronic components used in your installation are capable of operating at the voltage you plan to use.

GBP-1

Rated voltage: 3.7V to 7.4V DC* (Operating Voltage:3.5V to 8.4V)

Current Drain: 62mA

Operating Temperature: 14°F to 113°F (-10°C to +45°C)

Display: 128 x 64 dot graphics

Size: 2.126in [54mm](W)/3.543in [90mm](L)/0.6102in [15.5mm](H)

Weight(RPM sensor): 1.88oz [53.3g]

FUTABA CORPORATION

oak kandakajicho 8F 3-4 Kandakajicho, Chiyoda-ku, Tokyo 101-0045, Japan

TEL: +81-3-4316-4820, FAX: +81-3-4316-4823