

12K

14-Channel Digital Proportional R/C System

S.BUS 2™



INSTRUCTION MANUAL



1M23N33602

Futaba®

Digital Proportional R/C System

TABLE OF CONTENTS

INTRODUCTION	4	BASIC OPERATION	39
●Support and Service	4	●How to Turn Transmitter Power ON/OFF ...	39
●Application, Export, and Modification	5	●User Name Registration	39
●Compliance Information.....	5	●Home Screen	40
●Safety Precautions (do not operate without reading)	7	●User Menu	41
<hr/>		●Link Procedure T-FHSS Air	42
BEFORE USE	11	●Link Procedure S-FHSS	44
●Features of T12K	11	●Range Testing Your R/C System.....	45
●Contents and Technical Specifications.....	12	<hr/>	
●System Compatibility	12	RECEIVER AND SERVO INSTALLATION .	46
●Accessories.....	13	●Servo Connection By Model Type	46
●Transmitter Controls.....	15	●Model Basic Setting Procedure.....	49
●Installation and Removal of the Battery	16	<hr/>	
●Battery Charging	17	FUNCTIONS OF SYSTEM MENU	55
●Transmitter's Antenna	18	Trainer.....	56
●Switch (SA-SH)	19	Display.....	59
●Stick Control	19	User Name.....	60
●Stick Adjustment	23	Sound.....	61
●Digital Trims T1-T4.....	25	H/W Setting.....	62
●Push Dial Operation	26	Start SEL.	64
●HOME/EXIT and U.MENU/MON. Button .	27	Auto Lock	67
●Volume	27	Information	68
●Slide Lever.....	27	SBUS Servo	69
●Connector / Plug	28	<hr/>	
●Micro SD Card.....	29	FUNCTIONS OF LINKAGE MENU	74
●Receiver Nomenclature	31	(Common Functions)	
●Receiver's Antenna Installation.....	33	Linkage Menu Functions Table	74
●S.BUS/S.BUS2 Installation	35	Servo Monitor.....	75
●S.BUS Wiring example.....	36	Model Select.....	76
●S.BUS2 System.....	37	Model Type.....	78
●Telemetry System.....	38	System	80
		Function	81
		Sub-Trim	83
		Reverse	84
		Fail Safe.....	85
		End Point	86
		Servo Speed	87

Throttle Cut (Air/Heli Only).....	88	THR Delay (Air Only)	139
Idle Down (Air Only)	89	AIL Differential (Air/Glid Except 1-AIL)..	140
Swash Ring (Heli Only)	90	Flap Setting (Air/Glid 2-FLP and Up)	142
Swash (Heli Only, Except H-1).....	91	AIL to Camber FLP (Air/Glid 2-AIL+2-FLP and Up)	143
T1-T4 Setting	94	AIL to Brake FLP (Glid Only, 4-FLP)	144
Stick Alarm	95	AIL to RUD (Air/Glid).....	145
Warning.....	96	RUD to AIL (Air/Glid).....	146
Telemetry Set	97	Camber Mix (Air/Glid Except 1-AIL).....	148
Telemetry.....	100	ELE to Camber (Air/Glid Except 1-AIL)..	150
Telemetry:Rx-batt.....	104	Camber FLP to ELE (Air/Glid 2-AIL+1-FLP and Up).....	151
Telemetry:Ext-volt	105	Butterfly (Glid Only, Normal Wing 2-AIL and Up, Flying Wing 2-AIL+1FLP and Up)...	153
Telemetry:Temp.....	106	Trim Mix (Glid Only, 2-AIL and Up).....	155
Telemetry:RPM	107	Airbrake (Air Only, 2-AIL and Up).....	157
Telemetry:Altitude	108	Gyro (Air/Glid/Multirotor)	159
Telemetry:Vario.....	109	V-tail (Air/Glid)	161
Telemetry:Battery	112	Ailevator (Air/Glid).....	162
Telemetry:Distance.....	113	Winglet (Flying Wing Only).....	163
Telemetry:Speed	115	Motor (Air/Glid).....	164
Telemetry:Servo Sensor	116	RUD to ELE (Air Only).....	166
Telemetry:Current Sensor.....	119	Snap Roll (Air Only).....	167
Sensor	122	FLY Mode (Multirotor Only)	169
Sensor: Reload.....	123	•Helicopter Functions	170
Sensor: Register.....	123	Model Menu Functions List	170
Sensor: Relocate	124	PIT Curve/Pit Trim.....	171
Sensor: Set Slot.....	124	THR Curve/Throttle Hover Trim/Throttle Limiter	174
Data Reset	125	THR Hold.....	177
FUNCTIONS OF MODEL MENU	126	Swash Mix	178
•Common Functions	126	Throttle Mix.....	179
Servo Monitor (Linkage Menu)		PIT to RUD (Revolution Mix).....	180
Condition (Glid/Heli Only).....	127	Gyro (for GY Type Gyro)	181
Dual Rate	129	Governor	184
Program Mix.....	131		
Fuel Mix (Air/Heli Only)	133	APPENDIX.....	187
•Airplane/Glider/Multirotor Functions	135	Timer ST1/ST2	187
Model Menu Functions List	135	Switch Setting Method.....	190
Pitch Curve (Air Only)	137		
THR Curve (Air/Glid/Multirotor).....	138		

Technical updates and additional programming examples available at:
<http://www.futaba-rc.com/faq> **Entire Contents © 2017**

INTRODUCTION

Thank you for purchasing a Futaba® T-FHSS Air-2.4GHz* T12K series digital proportional R/C system. This system is extremely versatile and may be used by beginners and pros alike. In order for you to make the best use of your system and to fly safely, please read this manual carefully. If you have any difficulties while using your system, please consult the manual, our online Frequently Asked Questions (on the web pages referenced below), your hobby dealer, or the Futaba Service Center.

Due to unforeseen changes in production procedures, the information contained in this manual is subject to change without notice.

Support and Service: It is recommended to have your Futaba equipment serviced annually during your hobby's "off season" to ensure safe operation.

In North America

Please feel free to contact the Futaba Service Center for assistance in operation, use and programming. Please be sure to regularly visit the T12K Frequently Asked Questions web site at www.futaba-rc.com/faq/. This page includes extensive programming, use, set up and safety information on the T12K radio system and is updated regularly. Any technical updates and US manual corrections will be available on this web page. If you do not find the answers to your questions there, please see the end of our F.A.Q. area for information on contacting us via email for the most rapid and convenient response.

Don't have Internet access? Free internet access is available at most libraries and many other public resources. We find internet support to be a fabulous reference for many modelers as items can be printed and saved for future reference, and can be accessed at any hour of the day, night, weekend or holiday. If you do not wish to access the internet for information, however, don't worry. Our support teams are available Monday through Friday 8-5 Central time to assist you.

For Service Only:

Futaba Service Center
3002 N. Apollo Drive, Suite 1
Champaign, IL 61822
Phone: 217-398-0007
www.futaba-rc.com/service.html
Email: futabaservice@hobbico.com

For Support :

(Programming and user questions)

Please start here for answers to most questions:
www.futaba-rc.com/faq/
Fax: 217-398-7721
Phone: 217-398-8970 option 2

Outside North America

Please contact your Futaba importer in your region of the world to assist you with any questions, problems or service needs.

Please recognize that all information in this manual, and all support availability, is based upon the systems sold in North America only. Products purchased elsewhere may vary. Always contact your region's support center for assistance.

Application, Export, and Modification

1. This product may be used for unmanned aerial vehicle use. It is not intended for use in any application other than unmanned aerial vehicle control. The product is subject to regulations of the Ministry of Radio/Telecommunications and is restricted under Japanese law to such purposes.

2. Exportation precautions:

(a) When this product is exported from the country of manufacture, its use is to be approved by the laws governing the country of destination which govern devices that emit radio frequencies. If this product is then re-exported to other countries, it may be subject to restrictions on such export. Prior approval of the appropriate government authorities may be required. If you have purchased this product from an exporter outside your country, and not the authorized Futaba distributor in your country, please contact the seller immediately to determine if such export regulations have been met.

(b) Use of this product with anything other than models may be restricted by Export and Trade Control Regulations, and an application for export approval must be submitted. This equipment must not be utilized to operate equipment other than radio controlled models.

3. Modification, adjustment, and replacement of parts: Futaba is not responsible for unauthorized modification, adjustment, and replacement of parts on this product. Any such changes may void the warranty.

Compliance Information Statement (for U.S.A.)

This device complies with part 15 of the FCC Rules. Operation is subject to the following two conditions:

(1) This device may not cause harmful interference, and (2) This device must accept any interference received, including interference that may cause undesired operation.

(3) RF Radiation Exposure Statement (For T12K)

This equipment complies with FCC radiation exposure limits set forth for an uncontrolled environment.

This transmitter must not be co-located or operating in conjunction with any other antenna or transmitter.

RF Radiation Exposure Statement (For R3008SB)

This equipment complies with FCC radiation exposure limits set forth for an uncontrolled environment.

This equipment should be installed and operated with minimum distance 20cm between the radiator & your body.

The responsible party for the compliance of this device is:

Futaba Service Center

3002 N Apollo Drive Suite 1, Champaign, IL 61822 U.S.A.

TEL (217)398-8970 or E-mail: support@hobbico.com (Support)

TEL (217)398-0007 or E-mail: futabaservice@hobbico.com (Service)

CAUTION:

To assure continued FCC compliance:

Any changes or modifications not expressly approved by the grantee of this device could void the user's authority to operate the equipment.

Declaration of Conformity (for EU)

Hereby, Futaba Corporation declares that the radio equipment type is in compliance with Directive 2014/53/EU.

The full text of the EU declaration of conformity is available at the following internet address:

<http://www.rc.futaba.co.jp/english/dl/declarations.html>

IC

This device complies with Industry Canada license-exempt RSS standard(s). Operation is subject to the following two conditions: (1) this device may not cause interference, and (2) this device must accept any interference, including interference that may cause undesired operation of the device.

This equipment complies with IC radiation exposure limits set forth for an uncontrolled environment. This transmitter must not be co-located or operating in conjunction with any other antenna or transmitter.

French:

Cet appareil radio est conforme au CNR d'Industrie Canada. L'utilisation de ce dispositif est autorisée seulement aux deux conditions suivantes : (1) il ne doit pas produire de brouillage, et (2) l'utilisateur du dispositif doit être prêt à accepter tout brouillage radioélectrique reçu, même si ce brouillage est susceptible de compromettre le fonctionnement du dispositif.

Cet équipement est conforme aux limites d'exposition au rayonnement du CI établies pour un environnement non contrôlé. Cet émetteur ne doit pas être co-situé ou fonctionner conjointement avec une autre antenne ou émetteur.

Battery Recycling (for U.S.A.)



The RBRC™ SEAL on the (easily removable) nickel-cadmium battery and nickel-metal hydride battery contained in Futaba products indicates that Futaba Corporation is voluntarily participating in an industry program to collect and recycle these batteries at the end of their useful lives, when taken out of service within the United States. The RBRC™ program provides a convenient alternative to placing used nickel-cadmium batteries and nickel-metal hydride batteries into the trash or municipal waste system, which is illegal in some areas. You may contact your local recycling center for information on where to return the spent battery. Please call 1-800-8-BATTERY for information on NiCd/NiMH battery recycling in your area. Futaba Corporation's involvement in this program is part of its commitment to protecting our environment and conserving natural resources.

NOTE: Our instruction manuals encourage our customers to return spent batteries to a local recycling center in order to keep a healthy environment.

RBRC™ is a trademark of the Rechargeable Battery Recycling Corporation.

Flying Safety

Where to Fly

We recommend that you fly at a recognized model airplane flying field. You can find model clubs and fields by asking your nearest hobby dealer, or, in the US, by contacting the Academy of Model Aeronautics.

The national Academy of Model Aeronautics (AMA) has more than 2,500 chartered clubs across the country. Through any one of them, instructor training programs and insured newcomer training are available. Contact the AMA at the address or toll-free phone number below.

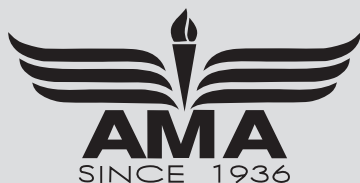

Academy of Model Aeronautics

5161 East Memorial Drive

Muncie, IN 47302

Tele. (800) 435-9262

Fax (765) 289-4248

or via the Internet at <http://www.modelaircraft.org>

Always pay particular attention to the flying field's rules, as well as the presence and location of spectators, the wind direction, and any obstacles on the field. Be very careful flying in areas near power lines, tall buildings, or communication facilities as there may be radio interference in their vicinity.

Precautions

Application, Export, and Modification Precautions.

1. This product is designed only for use with radio control models. Use of the product described in this instruction manual is limited to radio control models.
2. Export precautions:
 - a) When this product is exported, it cannot be used where prohibited by the laws governing radio waves of the destination country.
 - b) Use of this product with other than models may be restricted by Export and Trade Control Regulations.
3. Modification, adjustment, and parts replacement
Futaba is not responsible for unauthorized modification, adjustment, or replacement of parts on this product.

No part of this manual may be reproduced in any form without prior permission.

The contents of this manual are subject to change without prior notice.

Futaba is not responsible for the use of this product by the customer.

Company and product names in this manual are trademarks or registered trademarks of the respective company.

For safe use

Please observe the following precautions to ensure safe use of this product at all times.

Meaning of Special Markings:

The parts of this manual indicated by the following marks require special attention from the standpoint of safety.

⚠ DANGER - Procedures which may lead to dangerous conditions and cause death/serious injury if not carried out properly.

⚠ WARNING - Procedures which may lead to a dangerous condition or cause death or serious injury to the user if not carried out properly, or procedures where the probability of superficial injury or physical damage is high.

⚠ CAUTION - Procedures where the possibility of serious injury to the user is small, but there is a danger of injury, or physical damage, if not carried out properly.

⊘ = Prohibited ! = Mandatory

WARNING: Always keep electrical components away from small children.

Flying Precautions

⚠ WARNING

⊘ **Never grasp the transmitter antenna while flying.**

■ The transmitter output may drop drastically.

⊘ **Always make sure that all transmitter stick movements operate all servos properly in the model prior to flight. Also, make sure that all switches, etc. function properly as well. If there are any difficulties, do not use the system until all inputs are functioning properly.**

⊘ **Never fly in the range check mode.**

■ In the dedicated range test range check mode, the transmitter output range is reduced and may cause a crash.

⊘ **While operating, never touch the transmitter with, or bring the transmitter near, another transmitter, a cellphone, or other wireless devices.**

■ Doing so may cause erroneous operation.

⊘ **Do not point the antenna directly toward the aircraft during flight.**

■ The antenna is directional and the transmitter output is weakest. (The strength of the radio waves is greatest from the sides of the antenna.)

⊘ **Never fly on a rainy day, when the wind is strong, and at night.**

■ Water could lead to failure or improper functionality and poor control of the aircraft which could lead to a crash.

⊘ **Never turn the power switch on and off during flight or while the engine or motor is running.**

■ Operation will become impossible and the aircraft will crash. Even if the power switch is turned on, operation will not begin until transmitter and receiver internal processing is complete.

⊘ **Do not fly when you are physically impaired as it could pose a safety hazard to yourself or others.**

⊘ **Do not touch the engine, motor, or FET amp during and immediately after use.**

■ These items may become hot during use.

⊘ **Do not fly at the following places:**

- Near another radio control flying field.
- Near or above people.
- Near homes, schools, hospitals or other places where people congregate.
- Near high voltage lines, high structures, or communication facilities.

⚠ **For safety, fly so that the aircraft is visible at all times.**

- Flying behind buildings or other large structures will not only cause you to lose sight of the aircraft, but also degrade the RF link performance and cause loss of control.

⚠ **From the standpoint of safety, always set the fail safe function.**

- In particular, normally set the throttle channel to idle. For a helicopter, set the throttle channel to maintain a hover.

⚠ **When flying, always return the transmitter setup screen to the Home screen.**

- Erroneous input during flight is extremely dangerous.

⚠ **Always check the remaining capacity of the transmitter and receiver batteries before each flying session prior to flight.**

- Low battery capacity will cause loss of control and a crash.

⚠ **Always check operation of each control surface and perform a range test before each flying session. Also, when using the trainer function, check the operation of both the teacher and student transmitter.**

- Even one transmitter setting or aircraft abnormality can cause a crash.

⚠ **Before turning on the transmitter:**

1. Always move the transmitter throttle stick position to the minimum (idle) position.

2. Turn on the transmitter first and then the receiver.

⚠ **To turn off the transmitter's power switch, wait until after the engine or motor has stopped (the state in which it will not rotate again), and then:**

1. Turn off the receiver power switch.

2. Then turn off the transmitter power switch.

- If the power switch is turned on/off in the opposite order, the propeller may rotate unexpectedly and cause a serious injury.

- Also always observe the above order when setting the fail safe function.

- Maximum low throttle: Direction in which the engine or motor runs at the slowest speed or stops.

⚠ **When adjusting the transmitter, stop the engine except when necessary. In the case of a motor, disconnect the wiring and to allow it to continue operation. When doing so, please exercise extreme caution. Ensure that the aircraft is secured and that it will not come into contact with anything or anyone. Ensure that the motor will not rotate prior to making any adjustments.**

- Unexpected high speed rotation of the engine may cause a serious injury.

Battery and Charger Handling Precautions

⚠ DANGER

⊘ **Do not recharge a battery that is damaged, deteriorated, leaking electrolyte, or wet.**

⊘ **Do not use the charger in applications other than as intended.**

⊘ **Do not allow the charger or battery to become wet.**

- Do not use the charger when it or your hands are wet. Do not use the charger in humid places.

⊘ **Do not short circuit the battery.**

⊘ **Do not solder or repair, deform, modify, or disassemble the battery and/or battery charger.**

⊘ **Do not drop the battery into a fire or bring it near a fire.**

⊘ **Do not charge and store the battery in direct sunlight or other hot places.**

⊘ **Do not charge the battery if it is covered with any object as it may become very hot.**

⊘ **Do not use the battery in a combustible environment.**

- The gas could ignite and cause an explosion or fire.

⚠ **Always charge the battery before each flying session.**

- If the battery goes dead during flight, the aircraft will crash.

⚠ **Charge the nickel-metal hydride battery with the dedicated charger supplied with the set.**

- Charging the battery past the specified value may cause a fire, combustion, rupture, or liquid leakage. When quick charging, do not charge the battery above 1C.

- Do not charge the battery while riding in a vehicle. Vibration will prevent normal charging.

! Insert the power cord plug firmly into the receptacle up to its base.

! Always use the charger with the specified power supply voltage.

■ Use the special charger by connecting it to a proper power outlet.

⚠WARNING

⊘ Do not touch the charger and battery for any length of time during charging.

■ Doing so may result in burns.

⊘ Do not use a charger or battery that has been damaged.

⊘ Do not touch any of the internal components of the charger.

■ Doing so may cause electric shock or a burn.

⊘ If any abnormalities such as smoke or discoloration are noted with either the charger or the battery, remove the battery from the transmitter or charger and disconnect the power cord plug and do not use the charger.

■ Continued use may cause fire, combustion, generation of heat, or rupture.

⊘ Do not subject the batteries to impact.

■ Doing so may cause fire, combustion, generation of heat, rupture, or liquid leakage.

⊘ Do not repeatedly charge a nickel-metal hydride battery in the shallow discharge state.

■ The battery memory effect will substantially shorten the battery life even if it is recharged.

⚠CAUTION

⊘ Do not use the nickel-metal hydride battery with devices other than the corresponding transmitter.

⊘ Do not place heavy objects on top of the battery or charger. Also, do not place the battery or charger in any location where it could fall.

■ Doing so may cause damage or injury.

⊘ Do not store or use the battery and charger where it is dusty or humid.

■ Insert the power cord plug into the receptacle only after eliminating the dust.

⊘ After the transmitter has been used for a long time, the battery may become hot. Immediately remove from the transmitter.

■ Not doing so may cause a burn.

! If the battery liquid should get in your eyes, do not rub your eyes, but immediately wash them with tap water or other clean water and get treated by a doctor.

■ The liquid can cause blindness.

! Use and store the battery and battery charger in a secure location away from children.

■ Doing so may cause electric shock or injury.

! If the battery leaks liquid or generates an abnormal odor, immediately move it to a safe place for disposal.

■ Not doing so may cause combustion.

! If the battery liquid gets on your skin or clothing, immediately flush the area with tap water or other clean water.

■ Consult a doctor. The liquid can cause skin damage.

! After the specified charging time has elapsed, end charging and disconnect the charger from the receptacle.

! When recycling or disposing of the battery, isolate the terminals by covering them with cellophane tape.

■ Short circuit of the terminals may cause combustion, generation of heat or rupture.

⊘ Do not charge the battery in extreme temperatures.

■ Doing so will degrade the battery performance. An ambient temperature of 10 °C to 30 °C (50F to 86F) is ideal for charging.

! Unplug the charger when not in use.

⊘ Do not bend or pull the cord unreasonably and do not place heavy objects on the cord.

■ The power cord may be damaged and cause combustion, generation of heat, or electric shock.

Micro SD Card (Commercial Product) Handling Precautions

*Read the instruction manual supplied with the micro SD card for details.

⚠WARNING

- ⊘ Never disassemble or modify the micro SD card.
- ⊘ Do not unreasonably bend, drop, scratch or place heavy objects on the micro SD card.
- ⊘ If smoke or an abnormal odor emanates from the card, immediately turn off the transmitter power.

⚠CAUTION

- ❗ Since the micro SD card is an electronic device, be careful of static electricity.
 - Static electricity may cause erroneous operation.
- ⊘ Do not use the micro SD card near radio and television sets, audio equipment, motors and other equipment that generates noise.
 - Doing so may cause erroneous operation.
- ⊘ Do not store the micro SD card in the following places:
 - Where the humidity is high
 - Where the temperature difference is severe
 - Where it is very dusty
 - Where the card will be exposed to shock and vibration
 - Near speakers and other magnetic devices

- ⊘ Do not use the micro SD card where it may be exposed to water, chemicals, oil, or other fluids.
 - Doing so may cause a fire or electric shock by short circuiting.

- ⊘ Do not insert foreign matter into the transmitter card slot.
 - Doing so will cause trouble.
- ⊘ Do not expose the card to shock and vibration and do not remove the card from the card slot while data is being written or read.
 - The data may be damaged or lost.

●Recorded data

The data recorded on the micro SD card cannot be compensated regardless of the contents or cause of the trouble or obstruction.
Futaba does not perform data restoration or recovery work.

Storage and Disposal Precautions

⚠WARNING

- ⊘ Keep wireless equipment, batteries, aircraft, etc. away from children.

⚠CAUTION

- ⊘ Do not store wireless devices in the following places:
 - Where it is extremely hot (40°C [104F] or higher) or cold (-10°C [14F] or lower)
 - Where the equipment will be exposed to direct sunlight
 - Where the humidity is high
 - Where vibration is prevalent
 - Where it is very dusty
 - Where the device may be exposed to steam and heat

- ❗ When the device will not be used for a long time, remove the battery from the transmitter and aircraft and store them in a dry place where the temperature is between 0C and 30C [32F and 86F].

- Left standing 'as is' may cause battery deterioration, liquid leakage, etc.

Other Precautions

⚠CAUTION

- ⊘ Do not directly expose plastic parts to fuel, oil, exhaust gas, etc.
 - If left in such an environment, the plastic may be attacked and damaged.
 - Since the metal parts of the case may corrode, always keep them clean.

- ❗ Join the Academy of Model Aeronautics.
 - The Academy of Model Aeronautics (AMA) provides guidelines and liability protection should the need arise.
- ❗ Always use genuine Futaba products such as transmitter, receiver, servo, ESC, battery, etc.

- Futaba is not responsible for damage sustained by combination with other than Futaba Genuine Parts. Use the parts specified in the instruction manual and catalog.

- ⊘ This product SHOULD NOT be used for devices that are directly related to human life, and those that could be harmful to the human body, such as the applications below.
 - (1) Medical Devices
 - (2) Aerospace/Aviation Related Devices
 - (3) Nuclear Devices, etc.

BEFORE USE

Features

T-FHSS Air system

The T12K transmitter has adopted the bidirectional communication system "T-FHSS Air". Data from the receiver can be checked on your transmitter. T-FHSS Air is a maximum 14 channels (linear 12 channels + switch 2 channels) 2.4GHz dedicated system.

S.BUS2 system

By using the S.BUS2 system, multiple servos, gyros and telemetry sensors are easily installed with a minimum amount of cables.

Model types

Six swash types are available for helicopters. Six types of main wings and three types of tail wings are available for airplanes, multicopters and gliders. Functions and mixing functions necessary for each model type are set in advance at the factory.

Data input

Large graphic LCD and new type Push dial substantially improve ease of setup.

Stick

Improved feel, adjustable length and tension.

NiMH battery

T12K is operated by a 6.0 V/1,800 mAh Nickel-Metal Hydride battery.

Micro SD card (Secure Digital memory card) (Not included)

Model data can be saved to a micro SD card (SD:32MB-2GB SDHC:4GB-32GB). When T12K transmitter software files are released, the software can be updated by using a micro SD card update.

Edit button

Two edit buttons are provided, and the operating screen can be immediately "Returned" to the HOME screen during operation. Setting operation can be performed easily by combining this button with a Push dial.

Vibration function

Selects a function that alerts the operator to various alarms and timers by vibrating the transmitter in addition to sounding a buzzer.

Contents and Technical Specifications

Your **T12K** includes the following components:

(Specifications and ratings are subject to change without notice.)

- T12K Transmitter
- R3008SB Receiver
- HT5F1800B NiMH Battery & Charger

*The set contents depend on the type of set.

Transmitter T12K

(2-stick, 14-channel, T-FHSS Air-2.4G system)

Frequency band: 2.4GHz band

RF power output: 100mW EIRP

System: T-FHSS Air, S-FHSS, switchable

Power supply: 6.0V HT5F1800B NiMH battery

Receiver R3008SB

(T-FHSS Air-2.4G system, dual antenna diversity, S.BUS system)

Frequency band: 2.4GHz band

RF power output: 25mW EIRP

Power requirement: 4.8V~7.4V battery or regulated output from ESC, etc. (*1)

Size: 0.98 x 1.86 x 0.56 in. (24.9 x 47.3 x 14.3 mm)

Weight: 0.36 oz. (10.1g)

(*1) When using ESCs, make sure that the regulated output capacity meets your usage application.

Note: The battery in the T12K transmitter is not connected to the battery connector at initial. Please connect the battery connector before use.

System Compatibility

The **12K** is a **2.4GHz T-FHSS Air system**. The transmitter can also be switched to **S-FHSS**. (However, the telemetry system cannot be used with S-FHSS.) The usable receivers are shown below.

Communications System	Usable Receivers (2017,11)
T-FHSS Air	R3006SB, R3008SB, R3001SB
S-FHSS	R2001SB, R2008SB, R2006GS, R2106GF

NOTE :

*The Futaba **T-FHSS Air** system **cannot** be used with Futaba **S-FHSS/FASST/FASSTest** systems. Use it with a **T-FHSS Air** system transmitter and receiver. The **T12K** is a **T-FHSS Air system**, but can also be used with an **S-FHSS** receiver by switching to **S-FHSS**. However, in this case the telemetry system cannot be used.

*The **T-FHSS Air system** and **T-FHSS** surface system are different. The **T12K** cannot be used with the **R304SB, R304SB-E** or **T-FHSS** surface system receivers.

Accessories

The following additional accessories are available from your dealer. Refer to a Futaba catalog for more information:

- HT5F1800B Transmitter battery pack - the (1800mAh) transmitter NiMH battery pack may be easily exchanged with a fresh one to provide enough capacity for extended flying sessions.
- FT2F2100B/FT2F1700B Transmitter LiFe battery pack can also be used by using an exclusive spacer. However, charge only with a charger designed for LiFe batteries.
- Trainer cord - the optional training cord may be used to help a beginning pilot learn to fly easily by placing the instructor on a separate transmitter. Note that the T12K transmitter may be connected to another T12K system, as well as to any other models of Futaba transmitters. The T12K transmitter uses one of the three cord plug types according to the transmitter connected. (Refer to the description at the TRAINER function instructions). The part number of this cord is: FUTM4405.
- Servos - There are various kinds of servos. Choose the Futaba servos that are suited for your model and purpose.
- Telemetry sensor - With an optional sensor, you can set up a bidirectional communication system to receive information about a model in flight.
[Temperature sensor : SBS-01T/TE] [Altitude sensor : SBS-01A/02A] [RPM sensor magnet type : SBS-01RM] [RPM sensor optical type : SBS-01RO] [GPS sensor : SBS-01G/02G] [Voltage sensor : SBS-01V] [S.BUS servo sensor : SBS-01S] [Current sensor : SBS-01C]
- Neck strap - Connect a neck strap to your T12K to make it easier to handle and keep your hands free to improve your flying precision.
- Y-harnesses, servo extensions, hub, etc - Genuine Futaba extensions and Y-harnesses, including a heavy-duty version with heavier wire, are available to aid in your larger model and other installations.
- Gyros - a variety of genuine Futaba gyros is available for your aircraft or helicopter needs.
- Governor - for helicopter use. Automatically adjusts throttle servo position to maintain a constant head speed regardless of blade pitch, load, weather, etc.
- Receivers - various models of Futaba receivers may be purchased for use in other models. (Receivers for T-FHSS Air and S-FHSS types are available.)

Throttle stick position warning

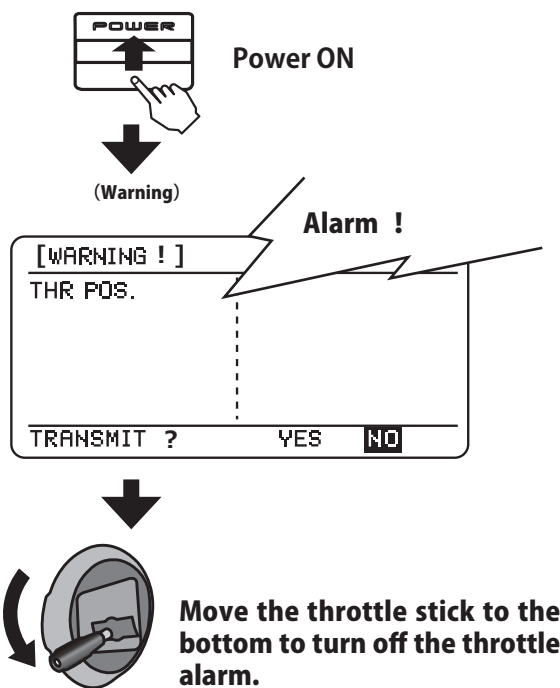

Release of the throttle position warning

LINKAGE MENU 2/2 ⇒ WARNING ⇒ THR POS. ⇒ OFF

WARNING	1/2
ON/OFF Vibes	
LOW BATTERY 5.6V	OFF
THR CUT	ON OFF
IDLE DOWN	ON OFF
THR POS.	ON OFF

WARNING

When using this transmitter with an RC airplane or helicopter, turn on a throttle position warning.

Transmitter Controls T12K

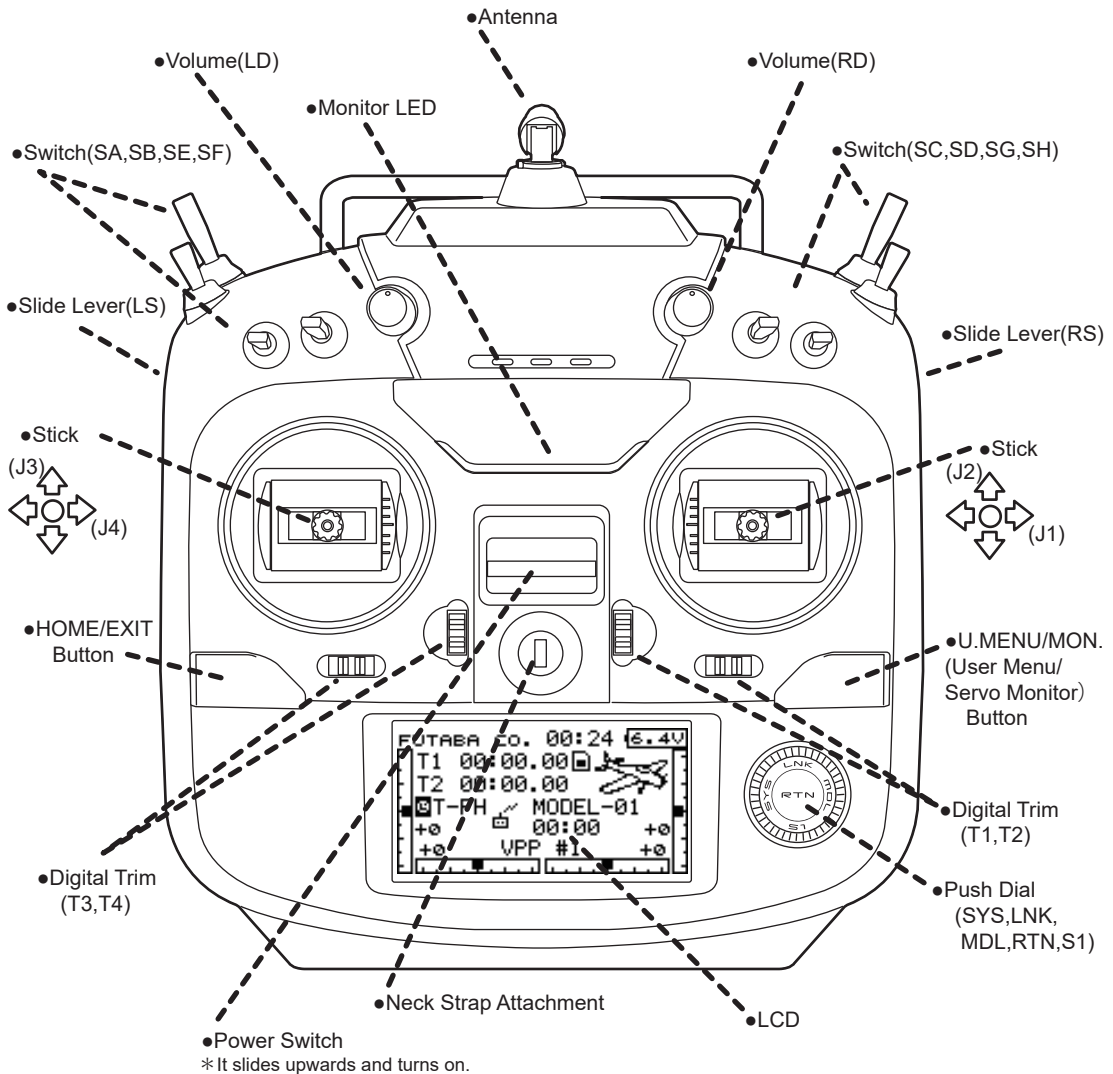

Installation and Removal of the Transmitter Battery

NiMH Battery HT5F1800B



Turn off the transmitter power switch.

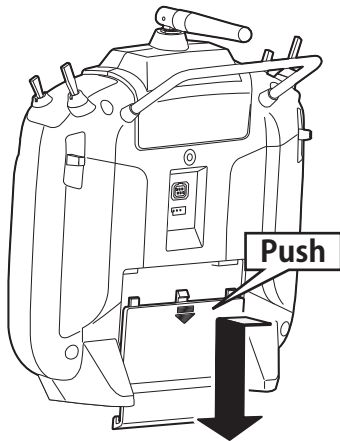

Slide the battery cover off the transmitter in the direction of the arrow in the figure.

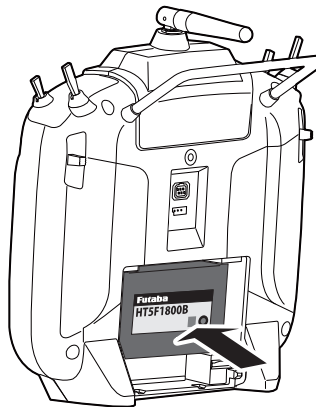

Insert the connector of the battery and load the battery into the transmitter.

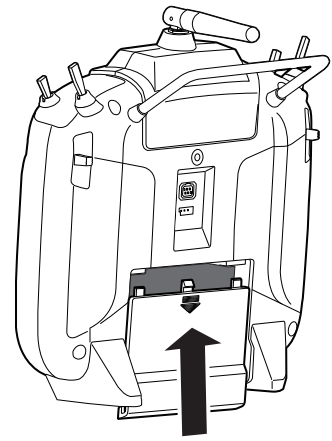

Finish by installing the battery cover.

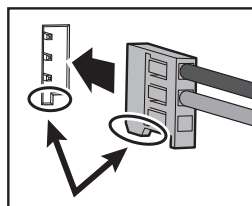

Connect the battery connector.

Danger

 When closing the battery cover, be careful that the battery cover does not pinch the battery lead wires.

Battery lead wire shorts could lead to abnormal heating, fire, and/or could cause burns or large scale fires.

Warning

 Be careful not to drop the battery.

 Never disconnect the battery before the T12K has completely shut down and the transmitter screen is blank.

* Internal devices such as memories may be damaged.

* If any problems occur, the message "Backup Error" will appear when you turn on the transmitter. If this happens, do not use the transmitter. Send it to the Futaba Service Center.

Battery Charging

Before charging batteries, read the "Battery and Charger Handling Precautions".

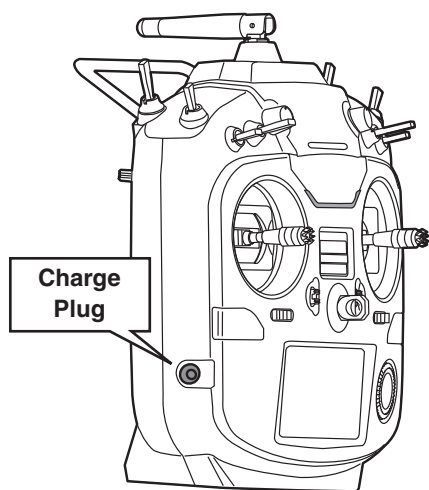

Connector for battery charger



This is the connector for charging the NiMH battery HT5F1800B that is installed in the transmitter. Do not use any other chargers except the attached special charger corresponding to NiMH battery.

Warning

-  Do not connect any other chargers except the special charger to this charging connector.

How to charge the NiMH battery HT5F1800B for the transmitter

Danger

-  The NiMH battery HT5F1800B is only for your T12K. Do not use this battery for other equipment.
-  Be sure to use the attached special charger to charge the battery.

[Method of charging battery]

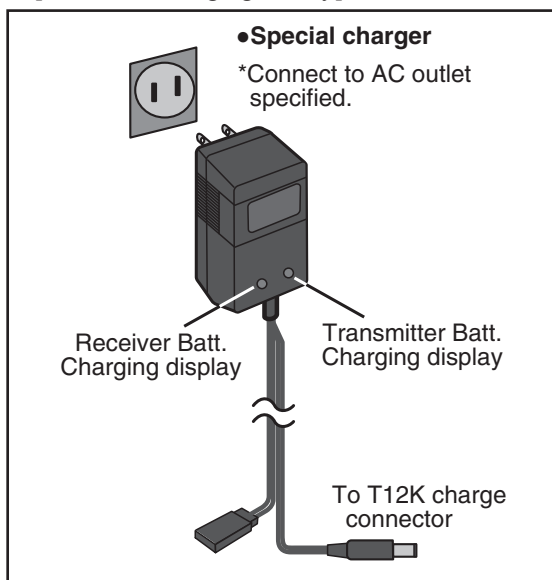

1. Connect the special charger to the wall socket (AC outlet).
2. Connect the connectors to the T12K charging jack.

*Confirm that the charging indicator, LED lamp, is on.

*Turn off the transmitter while charging the battery.

3. Remove the battery after 15 hours.

*Battery charging will not automatically stop. Remove the battery and transmitter from the charger and remove the charger from the wall socket.

*It is recommended to reactivate the battery by cycling several times if the battery has not been used for a long period.

*In the case of NiMH/NiCd batteries, you may find poor performance of the battery if you have used the battery only for a short period or if you repeat charging while the battery is not fully discharged. It is suggested to discharge the battery to the recommended level after use. It is also recommended to charge the battery just before use.

Transmitter Antenna

As with all radio frequency transmissions, the strongest area of signal transmission is from the sides of the transmitter antenna. As such, the antenna should not be pointed directly at the model. If your flying style creates this situation, easily move the antenna to correct this situation.

Rotating antenna

The antenna can be rotated 180 degrees and angled 90 degrees. Forcing the antenna further than this can damage it. The antenna is not removable.

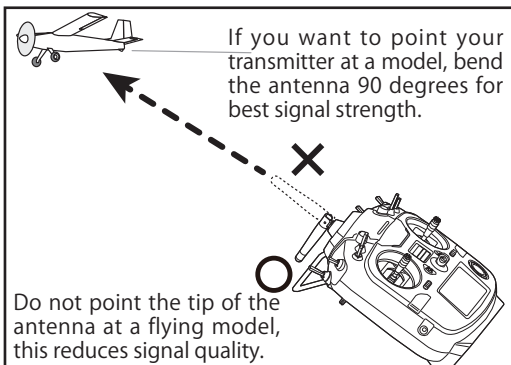
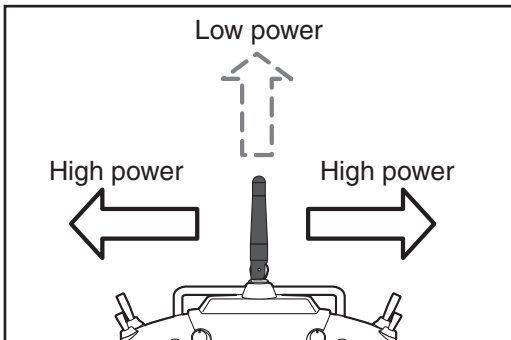
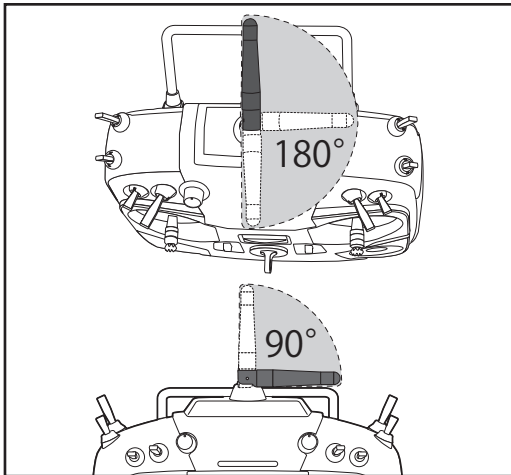

Caution

⚠ Please do not grasp the transmitter antenna during flight.

Doing so may degrade the quality of the RF transmission to the model

⊘ Do not carry the transmitter by the antenna.

This could damage the antenna and render the transmitter inoperable.

⊘ Do not pull the antenna forcefully.

This could damage the antenna and render the transmitter inoperable.

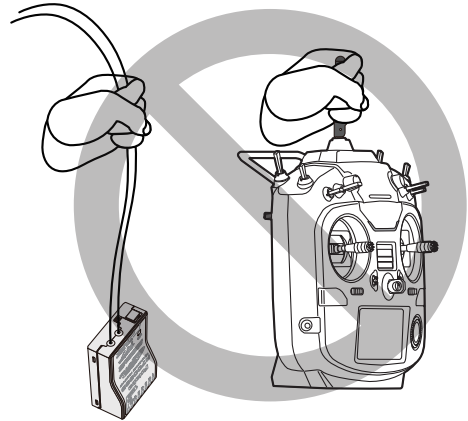

Monitor LED display

Transmitter status is displayed by LEDs.

LED

- Off
Radio waves are in the OFF state.
- On
Radio waves are being transmitted.
- Blinking
Power switch is turned on when any condition switch is activated (in the ON state).

Switch (SA-SH)

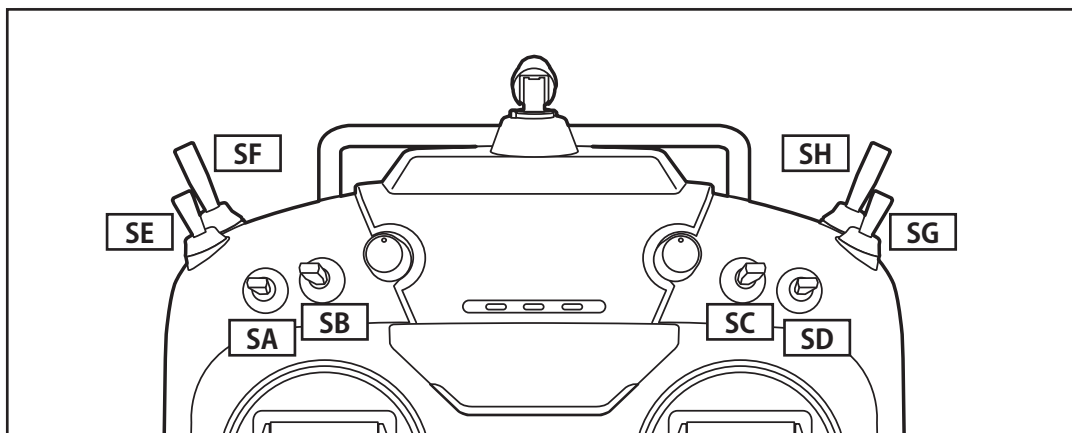

(Switch Type)

- SA : 3 positions; Alternate; Short lever
- SB : 3 positions; Alternate; Long lever
- SC : 3 positions; Alternate; Long lever
- SD : 3 positions; Alternate; Short lever
- SE : 3 positions; Alternate; Short lever
- SF : 2 positions; Alternate; Long lever
- SG : 3 positions; Alternate; Short lever
- SH : 2 positions; Momentary; Long lever

*You can choose switches and set the ON/OFF-direction in the setting screen of the mixing functions.

Stick Control

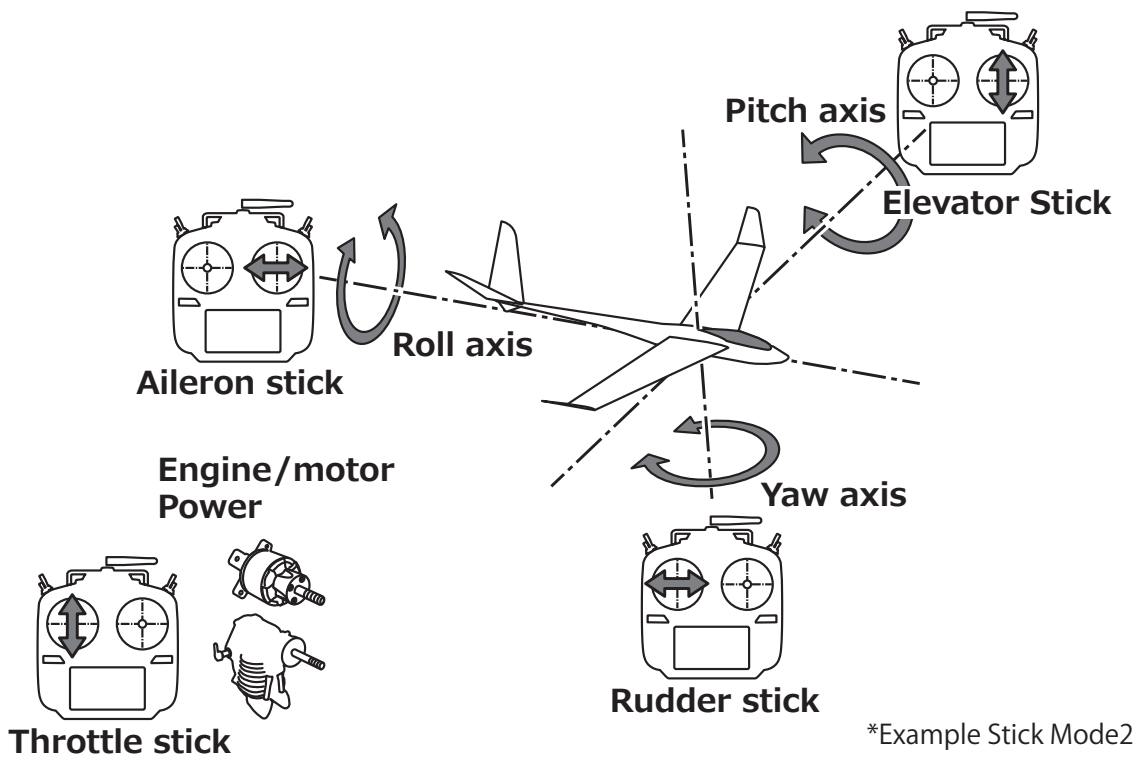

Stick control : Airplane Example

*Example Stick Mode2

A general model example. (There is also a different operational model.)

Roll Axis Control

Right roll
The right aileron is up.
The left aileron is down.

Aileron stick
↓
To the right

Level flight

Neutral

Left roll
The left aileron is up.
The right aileron is down.

Aileron stick
↓
To the left

Pitch Axis Control

Nose Up

Elevator stick
↓
UP
(moved to the bottom)

Level flight

Neutral

Nose Down

Elevator stick
↓
DOWN
(moved to the top)

Yaw Axis Control

Nose Right

Rudder stick
↓
To the right

Rudder is right.

Neutral

Straight

Rudder is left.

Rudder stick
↓
To the left

Nose Left

Throttle Control

High throttle

Throttle stick
↓
High
(moved to the top)

Middle

Throttle stick
↓
MIDDLE
(neutral)

Low throttle

Throttle stick
↓
SLOW
(moved to the bottom)

Stick control : Helicopter Example

*Example Stick Mode2

A general model example. (There is also a different operational model.)

Roll Axis Control

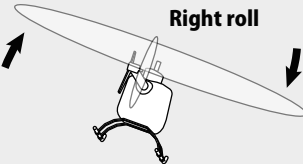
Right roll

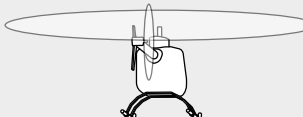
Aileron stick
To the right

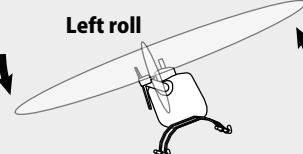
Level flight

Neutral

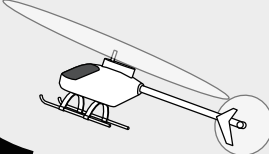
Left roll

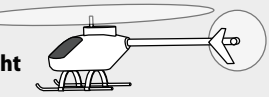
Aileron stick
To the left

Pitch Axis Control

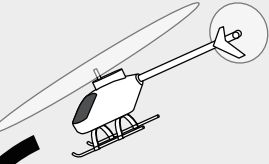
Nose Up

Elevator stick
UP
 (moved to the bottom)

Level flight

Neutral

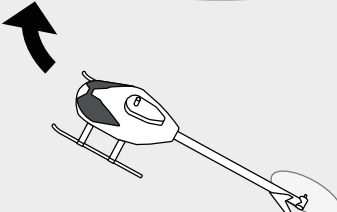
Nose Down

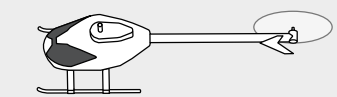
Elevator stick
DOWN
 (moved to the top)

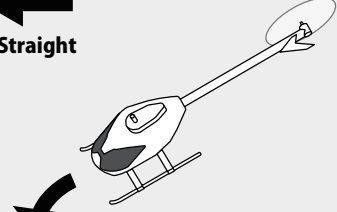

Yaw Axis Control

Nose Right

Rudder stick
To the right

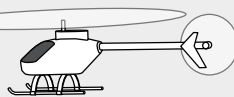

Straight

Neutral

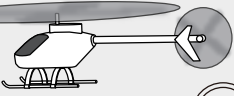
Nose Left

Rudder stick
To the left

Throttle /Pitch Control

Rise

Pitch Up  **High**
Throttle stick
High
 (moved to the top)

Hover

Throttle stick
MIDDLE
 (neutral)

Descend

Pitch Down  **Middle**
Throttle stick
SLOW
 (moved to the bottom)

Stick control : Multicopter Example

*Example Stick Mode2

A general model example. (There is also a different operational model.)

Roll Axis Control

Right roll
 Right slide → Aileron stick To the right

Hovering Level flight
 Neutral

Left roll
 Left slide ← Aileron stick To the left

Pitch Axis Control

Nose Up
 Back slide → Elevator stick UP (moved to the bottom)

Hovering Level flight
 Neutral

Nose Down
 Front slide ← Elevator stick DOWN (moved to the top)

Yaw Axis Control

Nose Right
 Rudder stick To the right

Hovering Level flight
 Neutral

Nose Left
 Rudder stick To the left

Throttle Control

Rise
 Throttle stick HIGH (moved to the top)

Hover
 Throttle stick MIDDLE (neutral)

Descend
 Throttle stick SLOW (moved to the bottom)

Stop

Stick Adjustment

Adjusting stick length

You can adjust the length of the sticks to fit your hand size. This is simple and recommended!

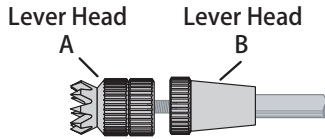

1. Hold lever head "B" and turn lever head "A" counter-clockwise to release the lock.
2. Adjust stick length, then hold lever head "B" and turn lever head "A" clockwise to lock.

Adjusting stick tension

You may adjust the tension of your sticks to provide the feel that you prefer for flying. To adjust the stick tension springs, you'll first have to remove the rear of the transmitter case.

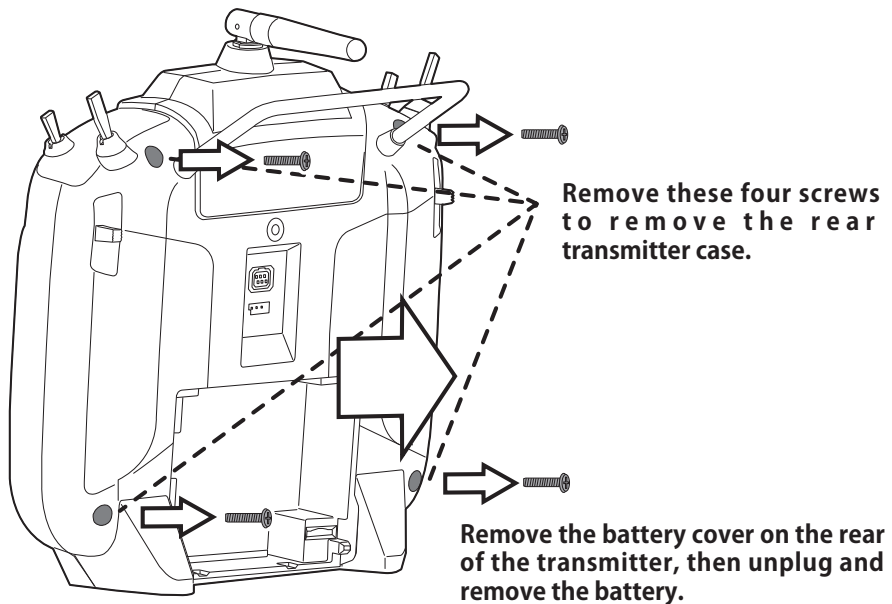

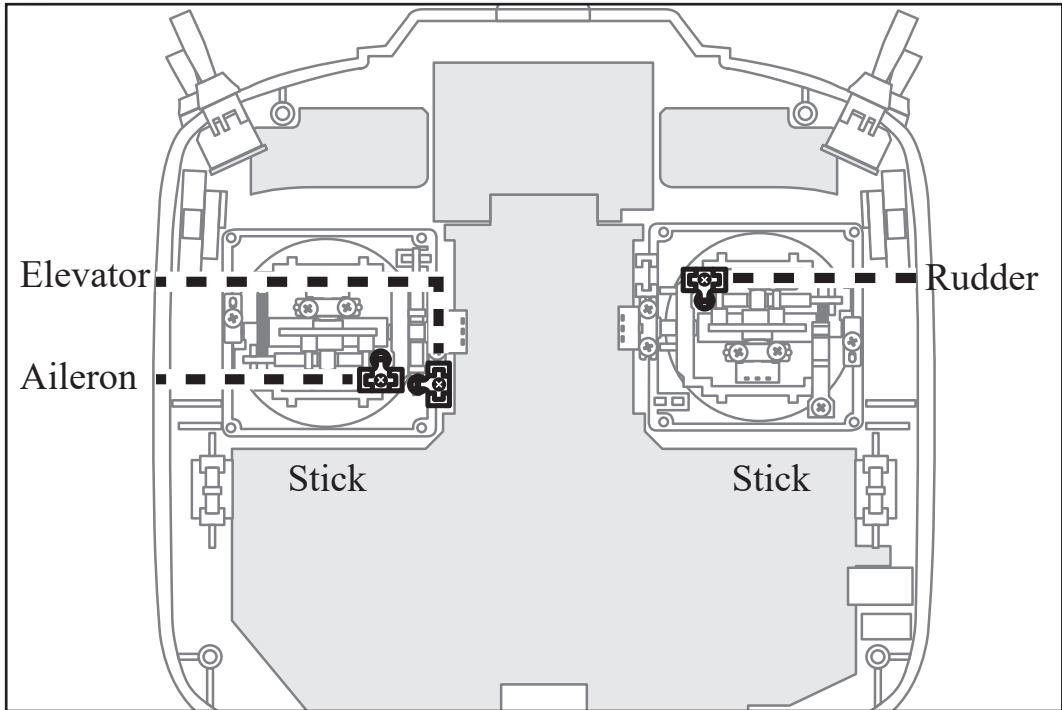

The interior of your transmitter should look like the figure above. Use a small Phillips screwdriver to rotate the adjusting screw of each stick for the desired spring tension. Increase tension by twisting clockwise, decrease tension by twisting counter clockwise. When you have found the desired stick tension, reattach the rear cover, install the four screws, then reinstall the battery and cover.

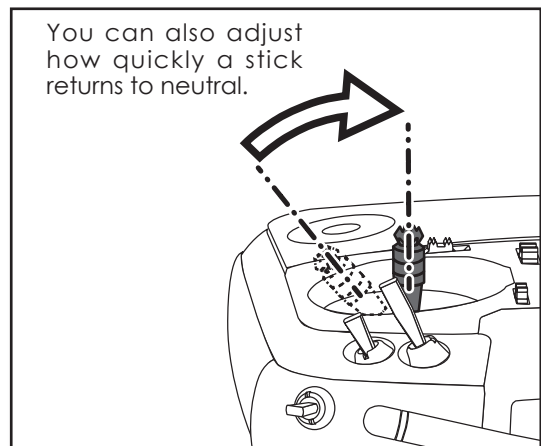
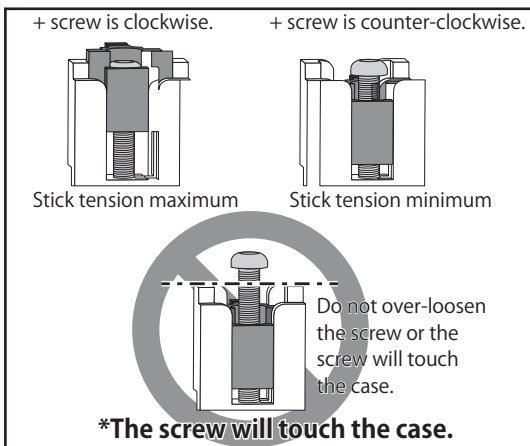

Digital Trims T1-T4

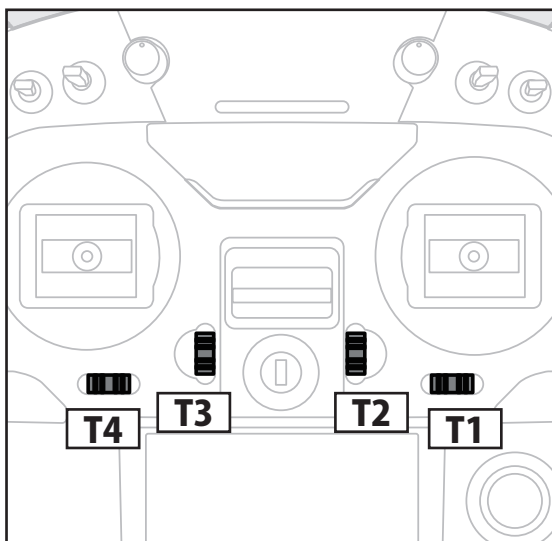

This transmitter is equipped with 4 digital trims. Each time you press a trim button, the trim position moves one step. If you continue pressing it, the trim position starts to move faster. In addition, when the trim position returns to the center, the tone will change. You can always monitor trim positions by referencing the LCD screen.

*You can select the trim step amount and the display unit on the home screen on the T1-T4 setting screen within the linkage menu.

Note: The trim positions you have set will be stored in the non-volatile memory and will remain there.

Digital trim operational example

*Example Stick Mode2

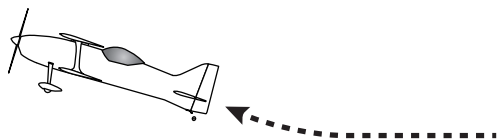

◆When the airplane goes up while the elevator stick is neutral.

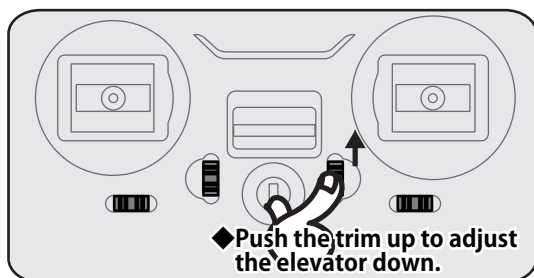

Elevator neutral

Down

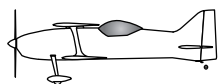
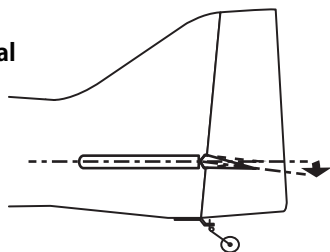

◆Adjust so that the airplane flies level.



◆When the airplane dives while the elevator stick is neutral.

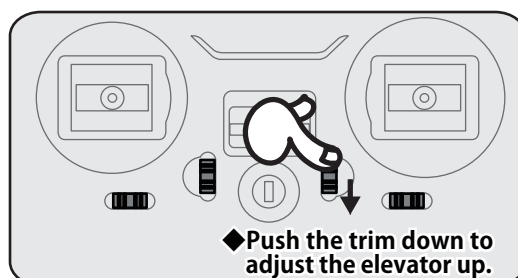

Elevator neutral

Up

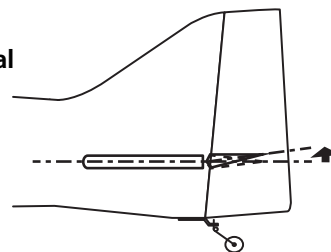

Push Dial Operation

Data input operation is performed using the Push dial.

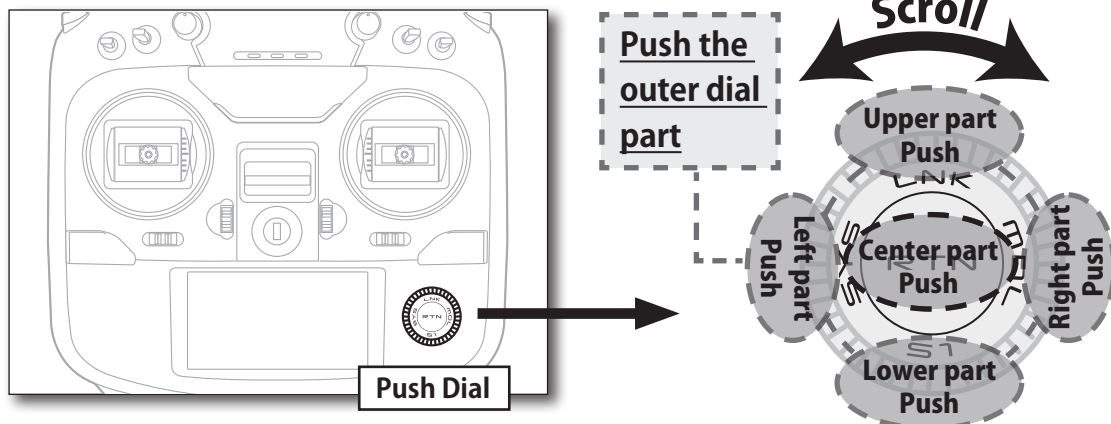

Push : Less than 1 second
Long Push : 1 second or more

Push Dial :

Dial Scroll	The cursor moves accordingly. Increases or decreases values accordingly.
Right part Long Push [SYS]	Jump to System Menu screen directly.
Upper part Long Push [LNK]	Jump to Linkage Menu screen directly.
Left part Long Push [MDL]	Jump to Model Menu screen directly.
Lower part Long Push [S1]	To Home screen
Lower part Push [S1]	The cursor moves to the top of next page. The cursor moves to the top of page.
Center part Long Push [RTN]	Reset to the initialized value.
Center part Push [RTN]	Change to the input data mode. Changes to the moving cursor mode. The data is entered.

Movement of cursor, value input or mode selection:

Movement of the cursor on the menu screen and movement of the cursor among items on a setup screen can be controlled by scrolling your finger to the left and right in the direction of the arrow in the scrolling diagram above. You can also go to the next page, if there is a next page.

This scrolling technique is also used for data input, value input, mode selection, and similar operations. Examples include: Value, ON, OFF, INH, ACT, etc.

RTN button:

Push the RTN button when you want to open a setup screen or to switch between cursor move mode (reverse display) and data input mode (box display).

This button can also be used as the enter button when a confirmation message is displayed on the screen, etc.

S1 button:

When there is a next page on a menu screen or setup screen, you can go to that page by touching the S1 button. In this case, the cursor moves to the screen title item of the page.

Exiting setup screen:

To end the operation on a setup screen and return to the menu screen, move the cursor to the screen title item and push the RTN button.

To return to home screen directly, touch the HOME/EXIT button for 1 second.

Alternatively, move the cursor to the screen title item and touch the RTN button to return to the home screen from a menu screen.

HOME/EXIT and U.MENU/MON. Button

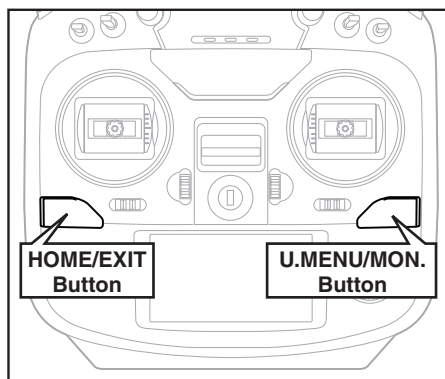

HOME/EXIT:



Press	Return to the previous screen
Press and hold	Return to the Home screen
If pushed in HOME screen.	To TELEMETRY display
Push and hold for one (1) second from HOME screen.	Key lock On or Off

U.MENU/MON.:

Press	To SERVO MONITOR display
Press and hold	To User Menu display

Volume

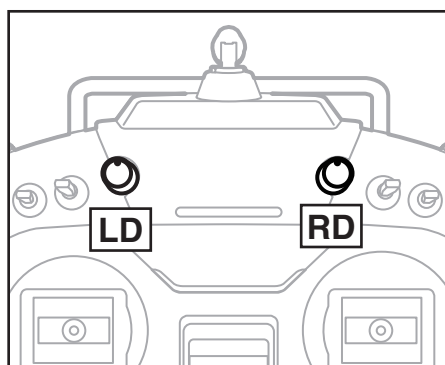

Volume LD and RD:

The volume LD and RD knobs allow for analog input.

*The T12K transmitter beeps when the volume knob reaches the center position.

*You can use each setting screen of the mixing functions to select volumes and define the direction of a movement.

Slide Lever

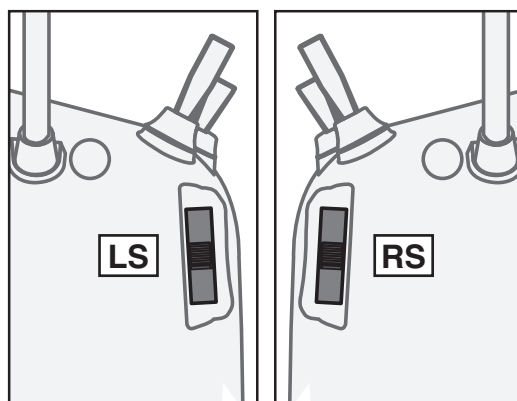

LS (Left), RS (right):

The slide lever LS and RS offer analog input.

*The T12K transmitter beeps when the lever comes to the center.

*You can select a slide lever and set the movement direction on the setting screen of mixing functions.

Connector / Plug

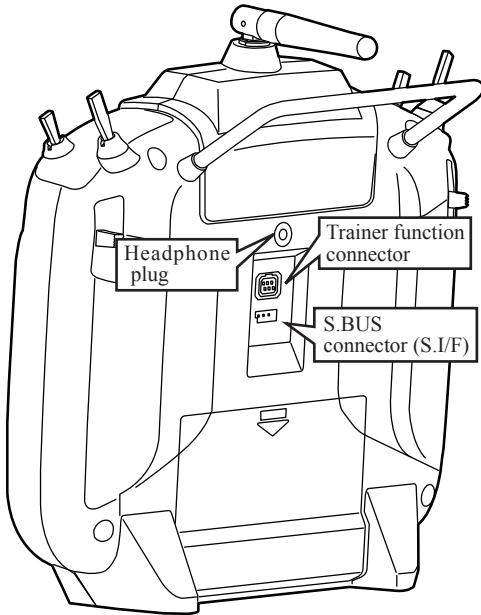

Headphone plug

Plug in commercial 3.5mm headphones to listen to telemetry data. (See telemetry section for detailed settings.)

Trainer function connector

When you use the trainer function, connect the optional trainer cable between the transmitters for teacher and student.

*You can set the trainer function on the Trainer Function screen.

S.BUS connector (S.I/F)

When setting an S.BUS servo and telemetry sensor, connect them both here.

(Supply power by 3-way hub or 2-way cord.)

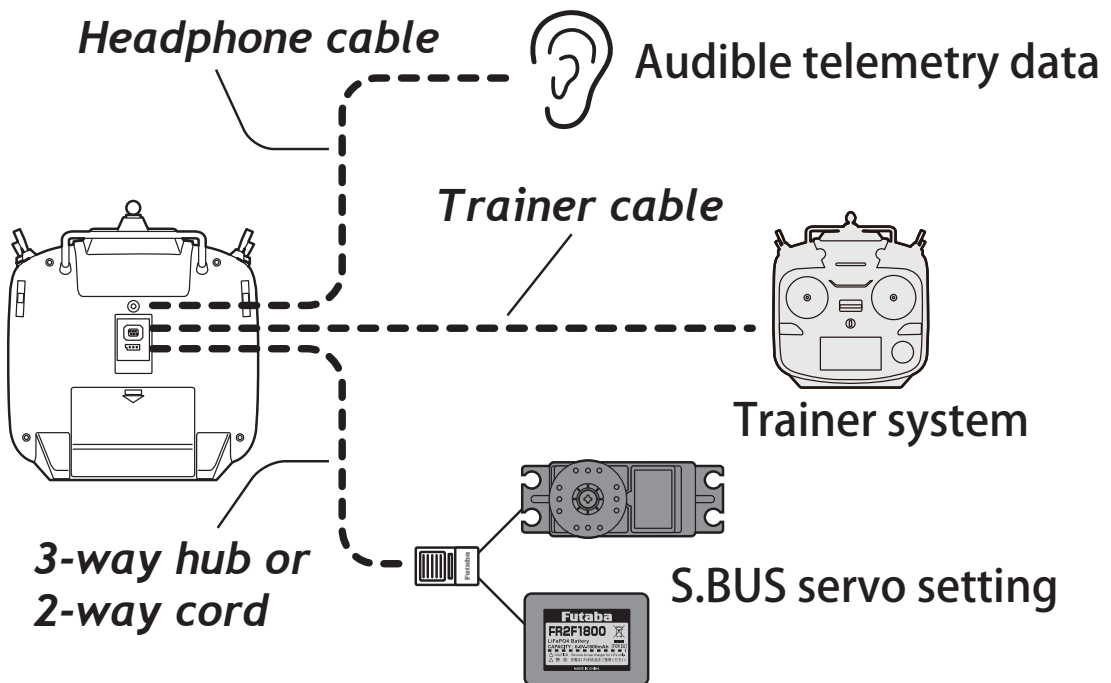

micro SD Card (Secure Digital memory card) (Not included)

The T12K transmitter model data can be stored by using any commonly found micro SD card. When T12K transmitter update software is released, the software is updated using a micro SD card.



(Commercial product)

SD standard and SDHC standard microSD cards SD/SDHC format. Maximum size 2GB. SDXC format is not supported.

(Some models may not be operated by card.)

*The data in the memory card cannot be guaranteed regardless of the contents and cause of trouble or damage. Always back-up the valuable data in the memory card.

Caution

 **Do not install or remove the micro SD card with the card slot pointing at your face.**

If you remove your fingers quickly, the micro SD card could pop out and strike your face, which could be dangerous.

 **Do not install and remove the micro SD card with the micro SD card slot facing your face.**

If you remove your fingers quickly, the microSD card may fly out and strike your face and is dangerous.

 **Since the micro SD card is a precision device, do not subject it to unreasonable force or shock.**

 **As the micro SD card is a precision device, do not use excessive force when installing it.**

Restrictions when using a micro SD card

The following restrictions apply when using a micro SD card:

*The micro SD card must first be initialized using the T12K dedicated format. The micro SD card cannot be used as is without formatting to the T12K.

*Initializing destroys all the data previously saved on the card.

*A micro SD card formatted to the T12K cannot be written directly from a PC by Windows Explorer, etc. The files must be converted and written by the Futaba File System software. Files are identified by number instead of name. This special conversion software can be downloaded from Futaba's web site at:

<http://www.futaba-rc.com/software-updates.html>

Inserting/removing the micro SD card

1. Turn off the transmitter power and then open the battery cover at the back side of the transmitter.

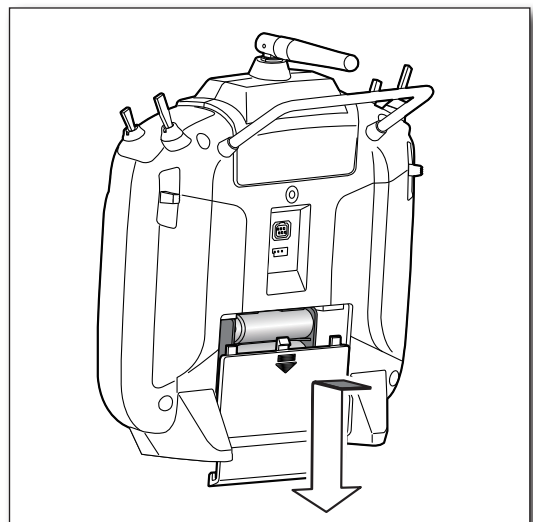

2. The micro SD card slot is shown in the figure below.

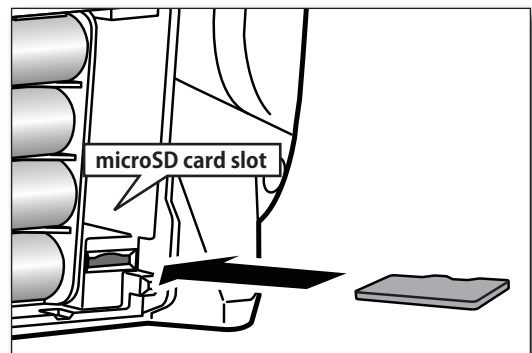

[Inserting the card]

Turn the micro SD card so that its front faces the rear of the transmitter and slide the card into the slot.

*Push the card in just until it is firmly seated in the slot.

[Removing the card]

To remove the card, press once to release the spring, then slide out the card.

3. Close the battery cover.

micro SD card initialization

To use a micro SD card with the T12K, the card must first be formatted. Once formatted, the card does not have to be reformatted. Formatting is performed by the T12K.

[IMPORTANT] When a micro SD card is formatted for the T12K, all pre-existing data is destroyed. **Do not format a card containing important data.**

[Formatting procedure]

1. Insert the micro SD card into the micro SD card slot of the T12K.
2. Turn on the T12K power. When an unformatted card is inserted into the T12K, the screen shown below appears.



3. If the T12K is ready to format, move the cursor to [FORMAT] and touch the RTN button. (To cancel formatting, move the cursor to [CANCEL] and touch the RTN button.)

4. Move the cursor to [YES] and touch the RTN button.

*Formatting starts. During formatting, the [NOW FORMATTING...] message is displayed.

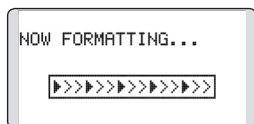

*When formatting is completed, The [FORMAT COMPLETED] message is displayed. Depending on the card capacity and speed, formatting may take as long as several minutes.

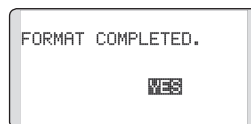

[IMPORTANT] Do not turn off the power until the [FORMAT COMPLETED] message is displayed.

5. End formatting by touching the RTN button.

micro SD card reader/writer

You can transfer model data and Futaba update files from your PC to the T12K using a micro SD card. SD card reading/writing equipment is available at most electronics stores.

Stored data

If you have a problem saving or reading data after a long period of use, we suggest obtaining a new micro SD card to avoid further difficulties.

*Futaba is not responsible for compensating any failure or damage to the data stored in the memory card. As such, we suggest that you maintain a backup of your important data contained on your micro SD card.

Receiver Nomenclature

Before using the receiver, be sure to read the precautions listed in the following pages.

Receiver R3008SB



Connector

"1 through 6": outputs for the channels 1 through 6

"7/B": outputs of 7 channels and power.
(7/B)

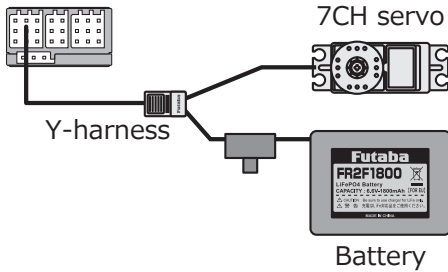

"8/SB": outputs of 8 channels or S.BUS port.

[S.BUS Servo S.BUS Gyro] —————>

*When using 8/SB as S.BUS, you have to set CH MODE of the following page to mode B/D/E.

"S.BUS2": outputs of S.BUS2 port. <-----

[S.BUS2 Servo S.BUS2 Gyro Telemetry Sensor] <-----

*When using 8 or more channels, use an S.BUS function or use a second R3008SB and link both to your transmitter.

Connector insertion

Firmly insert the connector in the direction shown in the figure. Insert the S.BUS2 by turning it 90 degrees.

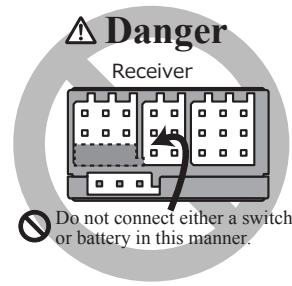
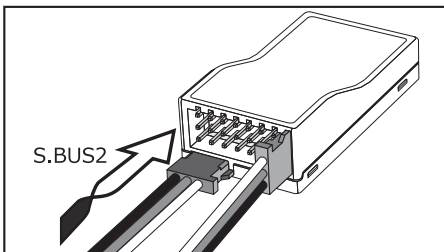

! Danger

⊘ Don't connect in the manner shown in the figure above.

*If connected in this way, the device will short-circuit. A short circuit may cause abnormal heating, fire, and/or burns.

⊘ Don't connect servo for conventional system to S.BUS/S.BUS2 port.

*Digital servos for conventional systems do not operate.

*Analog servos may cause abnormal heat, fires, and/or burns.

! Warning

S.BUS2 connectors

⊘ Don't connect an S.BUS servo / gyro to S.BUS2 connector.

LED Monitor

This monitor is used to check the CH mode of the receiver.

Mode Switch

Use the small plastic screwdriver that was included with your receiver.

Switch is also used for the CH mode selection.

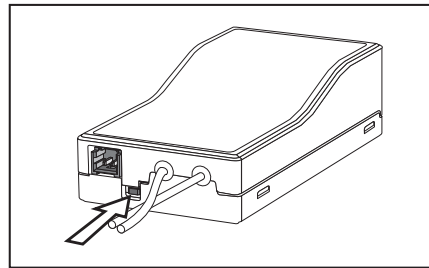

Extra Voltage Connector

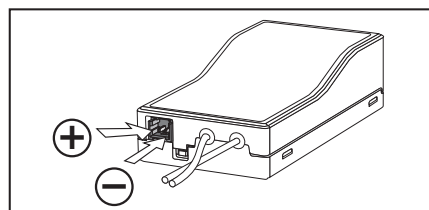

Extra Voltage Connector

Use this connector when using a voltage telemetry device to send the battery voltage (DC0 ~ 70V) from the receiver to the transmitter.

You will need to purchase the optional External Voltage input cable (CA-RVIN-700) FUTM5551.

You can then make a cable with an extra connector to the External voltage connector.

⚠ Danger

⊘ Don't touch wiring.

* There is a danger of receiving an electric shock.

⊘ Don't short-circuit the battery terminals.

* A short circuit across the battery terminals may cause abnormal heating, fire and burns.

⊘ Please double check your polarity (+ and -) when hooking up your connectors.

* If + and - of wiring are mistaken, it will damage, ignite and explode.

⊘ Don't connect to Extra Voltage before turning on a receiver power supply.

R3008SB CH MODE

The R3008SB receiver is a very versatile unit. It has 8 PWM outputs, S.BUS and S.BUS2 outputs. Additionally, the PWM outputs can be changed from channels 1-8 to channels 8-12(DG1,DG2). If you only desire to use it as a 7-channel receiver (without S.BUS), it can be used without any setting changes.

How to change the R3008SB Channel mode

The R3008SB is capable of changing its channel allocations as described in the table below.

1. Turn on the receiver. (At this moment, the transmitter should be off.) The LED will blink RED in about 3 seconds. Next, wait until it becomes solid RED.
2. Press and hold the Mode Switch for more 5 seconds.
3. Release the button when the LED blinks RED and GREEN simultaneously.
4. The receiver is now in the "Operation CH Set" mode. At this moment, the LED indicates current set status through flashing a pattern that corresponds to the CH mode.
 - *Cannot exit this CH setting mode before the operation mode is fixed.
 - *See the table below for LED flash codes and "CH mode" meanings.
 - *Default CH mode is "Mode B".
5. By pressing the Mode Switch, the operation CH is switched sequentially as "Mode C" "Mode D" "Mode E" "Mode A"....
6. Set your desired operation mode by holding the Mode Switch button for more than two seconds when you reach the desired mode.
7. Release the button when the LED blinks RED and GREEN simultaneously. Then, the operation CH is fixed.
8. Confirm that the CH mode is changed, turn off the receiver, and then turn it back on.

*The "Operation CH Set" mode cannot be exited while the receiver is connecting with the transmitter.

R3008SB CH Mode table

Output connector	Channel				
	Mode A 1 ~ 8CH	Mode B 1 ~ 7CH	Mode C 9 ~ 10CH	Mode D 9 ~ 10CH	Mode E 8 ~ 10CH
1	1	1	9	9	8
2	2	2	10	10	9
3	3	3	11	11	10
4	4	4	12	12	11
5	5	5	DG1	DG1	12
6	6	6	DG2	DG2	DG1
7/B	7	7	—	—	DG2
8/SB	8	S.BUS	—	S.BUS	S.BUS
Red LED blink	1 time	2 times	3 times	4 times	5 times

Default CH mode

Receiver's Antenna Installation

The R3008SB has two antennas. In order to maximize signal operation for safe modeling, Futaba uses a diversity antenna system. This system allows the receiver to use signals from both antenna and fly safely.

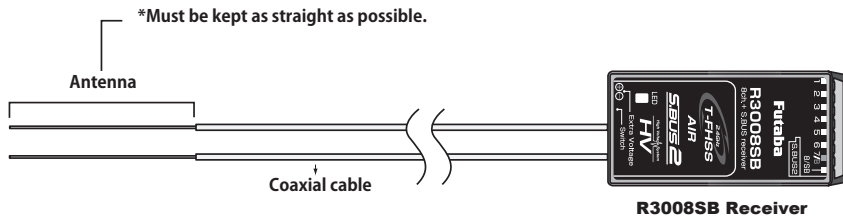

For best results, please follow these instructions:

1. To maximize range, keep the antennae as straight as possible.
2. Place the two antennae at a 90 degree angle to each other.

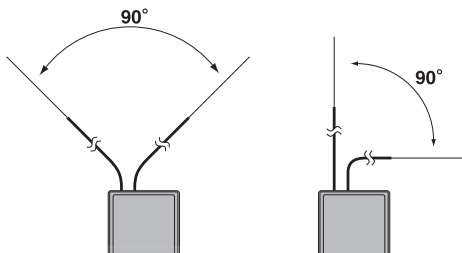

For best results, please keep the antennas to keep the antennas away from each other as much as possible.

Larger models can have large metal objects that can attenuate the RF signal. In this case, the antennas should be placed at both sides of the model. That way the best RF signal condition is obtained at any flying attitude.

3. The antennas must be kept away from conductive materials, such as metal, carbon and fuel tanks by at least half an inch. The coaxial part of the antennas does not need to follow these guidelines, but be sure not to bend it in a tight radius.
4. Keep the antennas away from the motor, ESC, and other noise sources as much as possible.

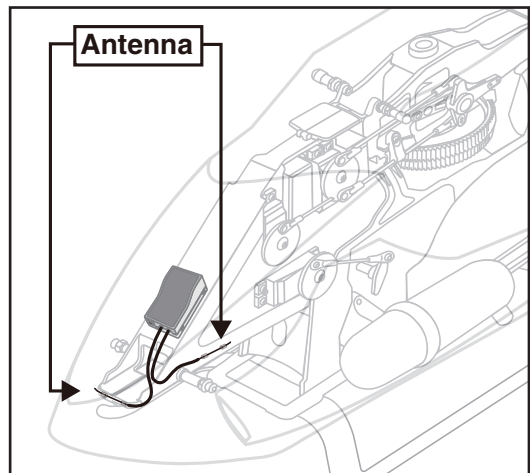
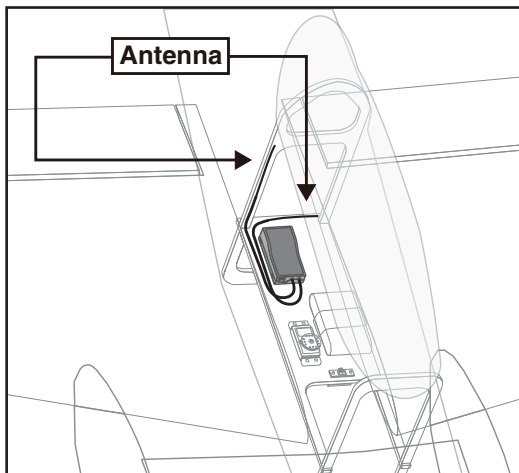

*The two antennas should be placed at 90 degrees to each other.

*The Illustration demonstrates how the antenna should be placed.

*Receiver Vibration and Waterproofing: The receiver contains precision electronic parts. Be sure to avoid vibration, shock, and temperature extremes. For protection, wrap the receiver in foam rubber or other vibration-absorbing materials. It is also a good idea to waterproof the receiver by placing it in a plastic bag and securing the open end of the bag with a rubber band before wrapping it with foam rubber. If you accidentally get moisture or fuel inside the receiver, you may experience intermittent operation or a crash. If necessary, return the receiver to our service center for repairs.

Mounting the Servo

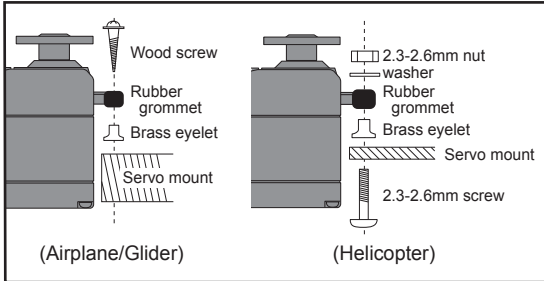

Servo lead wires

To prevent the servo lead cable from being broken by vibration during flight, provide a little slack in the cable and fasten it at suitable points. Periodically check the cable during daily maintenance.

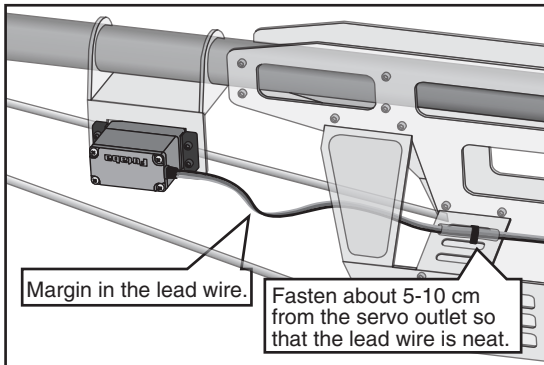

Mounting the power switch

When mounting a power switch to an airframe, make a rectangular hole that is a little larger than the total stroke of the switch so that you can turn the switch ON/OFF without binding.

Avoid mounting the switch where it can be covered by engine oil and dust. In general, it is recommended to mount the power switch on the side of the fuselage that is opposite the muffler.

Safety precautions when you install receiver and servos

Warning

Connecting connectors

! Be sure to insert the connector until it stops at the deepest point.

How to protect the receiver from vibration and water

! Wrap the receiver with something soft, such as foam rubber, to avoid vibration. If there is a chance of getting wet, put the receiver in a waterproof bag or balloon to avoid water.

Receiver's antenna

⊘ Never cut the receiver's antenna. Do not bind the receiver's antenna with servo cables.

! Place the receiver's antenna as far as possible from metals or carbon fiber components, such as frames, cables, etc.

*Cutting or binding the receiver's antenna will reduce the radio's reception sensitivity and range, and may cause a crash.

Servo throw

! Adjust your system so that pushrods will not bind or sag when operating the servos to the full extent.

*If excessive force is continuously applied to a servo, the servo could be damaged due to force on the gear train and/or power consumption, causing rapid battery drain.

Mounting servos

! Use vibration-proof rubber (such as a rubber grommet) under a servo when mounting the servo on a servo mount. Be sure that the servo cases do not touch directly to the metal parts, such as a servo mount.

*If the servo case contacts the airframe directly, vibration will travel to and possibly damage the servo.

S.BUS/S.BUS2 Installation

This set uses the S.BUS/S.BUS2 system. The wiring is as simplified and streamlined as possible, even with models that use a large number of servos. The wings can quickly be attached to the fuselage with one simple wire, even when a large number of servos are used.

- When using S.BUS/S.BUS2, special settings and mixes in your transmitter may be unnecessary.
- S.BUS/S.BUS2 servos memorize the number of channels themselves. (Settable with the T12K)
- The S.BUS/S.BUS2 system and conventional system (receiver conventional CH used) can be mixed.

S.BUS Glider usage example

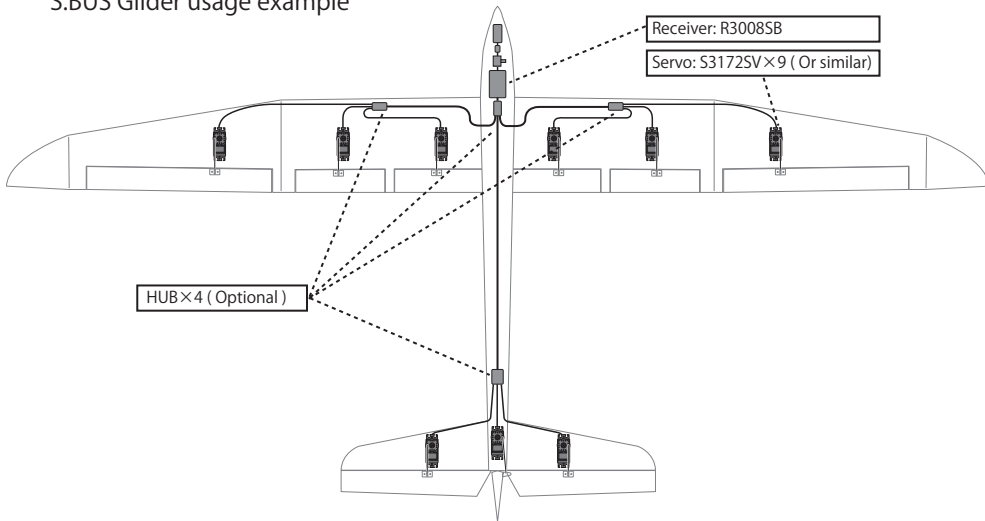

S.BUS Aerobatic plane usage example

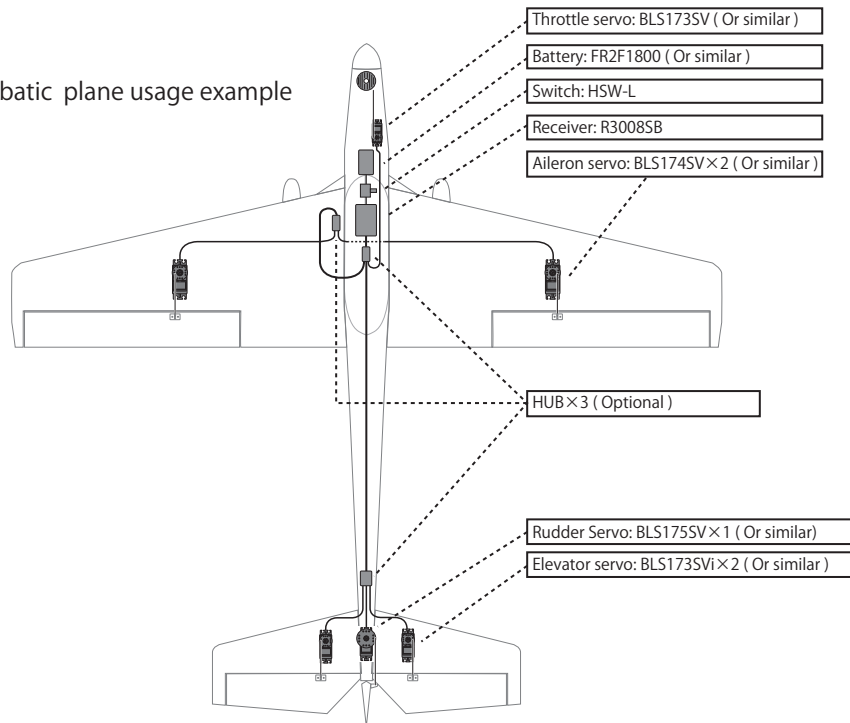

S.BUS Wiring example

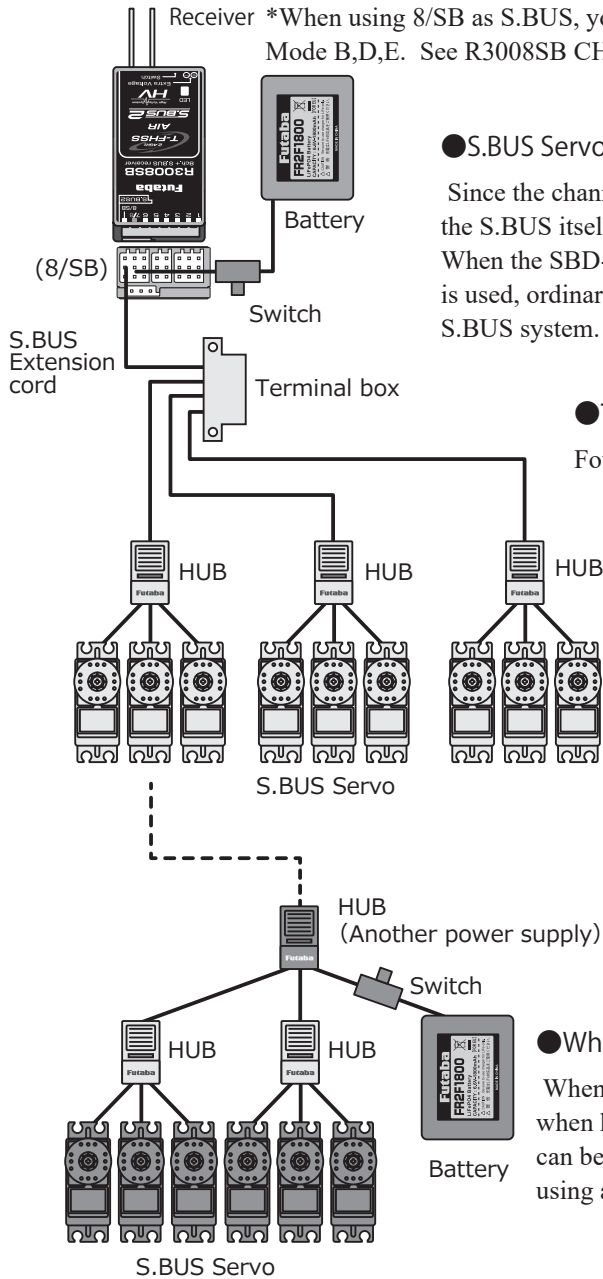

Receiver *When using 8/SB as S.BUS, you must set the receiver to Mode B,D,E. See R3008SB CH MODE TABLE.

● S.BUS Servo

Since the channel number is memorized by the S.BUS itself, any connector can be used. When the SBD-1 or SBD-2 (sold separately) is used, ordinary servos can be used with the S.BUS system.

● Terminal box

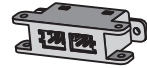

Four connectors can be inserted

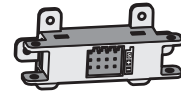

● Terminal box TB16PP

6 connectors can be inserted

⚠ Warning Power supply

❗ Please make sure that you use a battery that can deliver enough capacity for the number and kind of servos used. Alkaline batteries cannot be used.

● When separate power supply used

When a large number of servos are used or when high current servos are used, the servos can be driven by a separate power supply by using a separate Power Supply 3-way Hub.

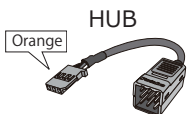

Three connectors can be inserted.

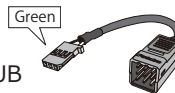

HUB

Used when using a separate power supply battery.

S.BUS2 System

When using the S.BUS2 port, an impressive array of telemetry sensors may be utilized.

S.BUS2 TABLE

Receiver port	S.BUS Servo S.BUS Gyro	S.BUS2 Servo S.BUS2 Gyro	Telemetry sensor
S.BUS	○	○	×
S.BUS2	×	○	○

(※) Don't connect S.BUS Servo,
S.BUS Gyro to S.BUS2 connector.

S.BUS servos and gyros and S.BUS2 servos and gyros must be used in the correct receiver ports. Please refer to the instruction manual to make sure you connect to the correct one.

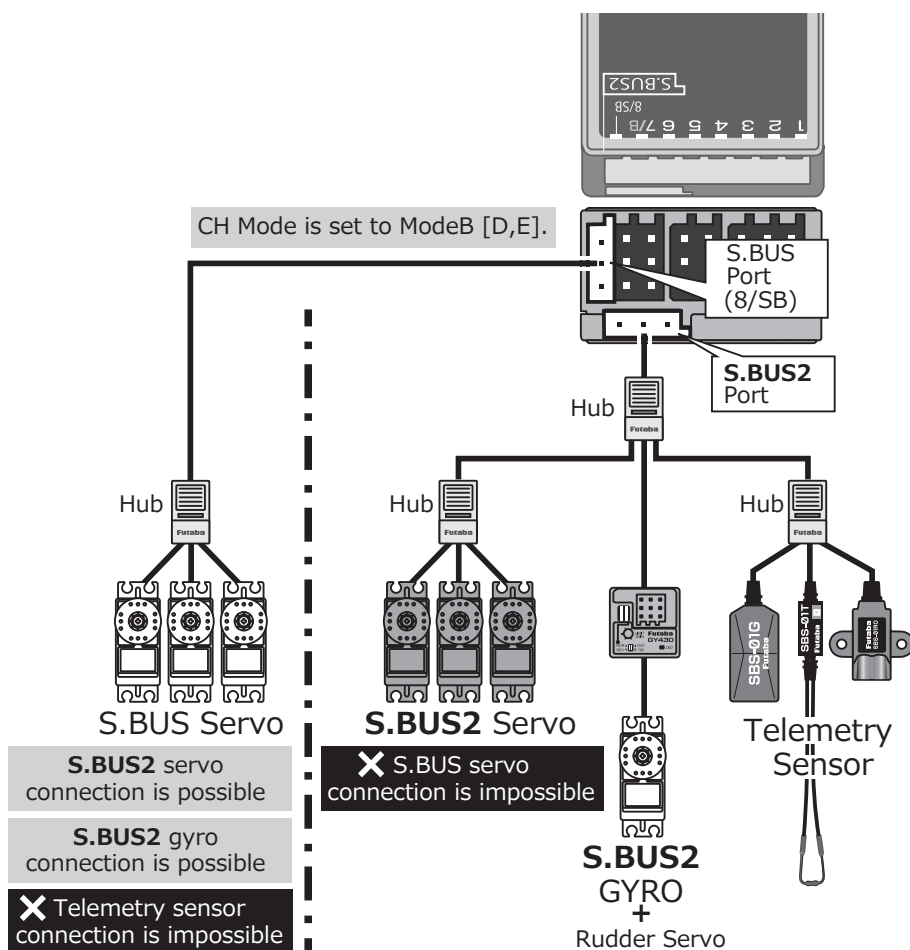

Telemetry System

The R3008SB receiver features bi-directional communication with a T-FHSS Air Futaba transmitter using the S.BUS2 port. Using the S.BUS2 port, an impressive array of telemetry sensors may be utilized. It also includes both standard PWM output ports and S.BUS output ports.

- * Telemetry is available only in the T-FHSS Air.
- * The telemetry function requires the corresponding receiver (R3008SB).
- * The T12K will enter and keep the ID number of the R3008SB that it is linked to.
- * When using multiple receivers with one transmitter, telemetry cannot be used.

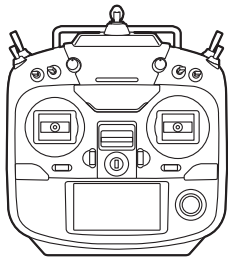

T12K

● Telemetry sensor (sold separately)

Aircraft data can be checked in the transmitter by connecting various telemetry sensors to the S.BUS2 connector of the receiver.

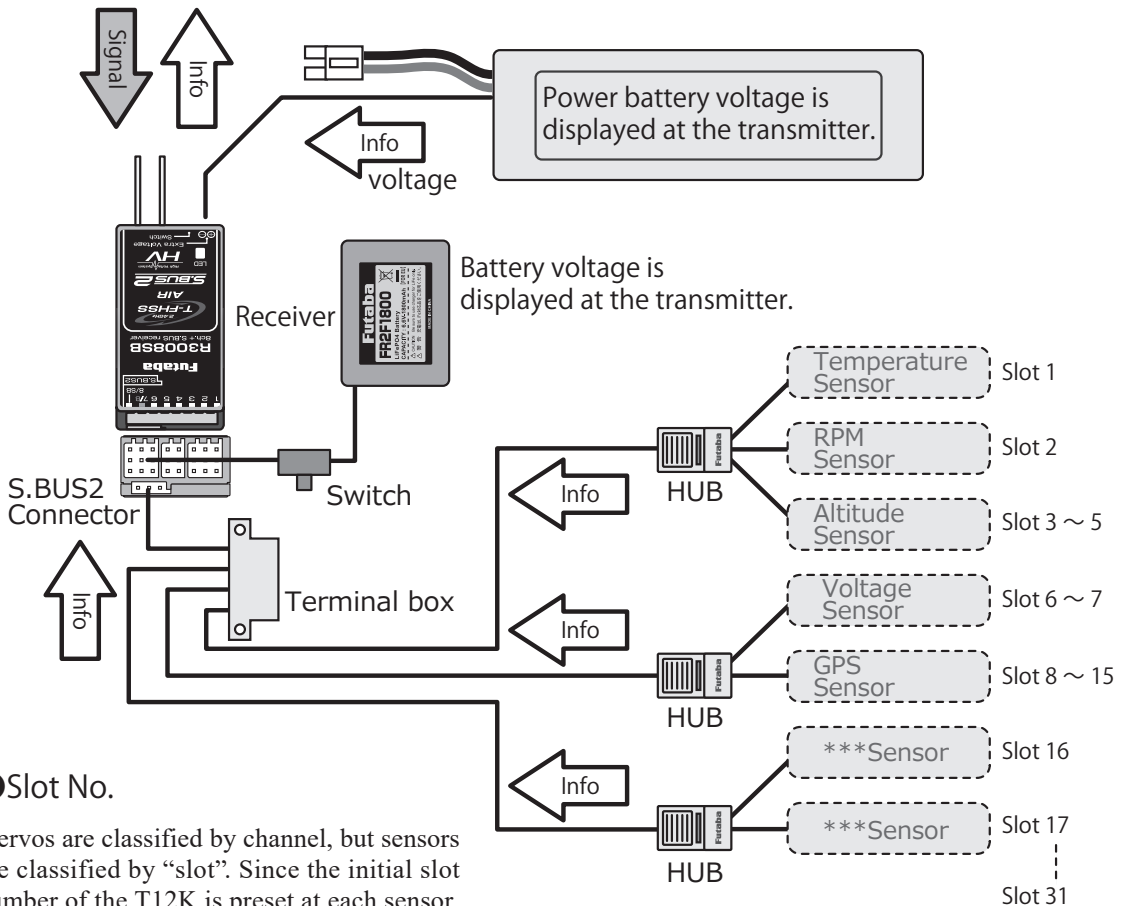

● Slot No.

Servos are classified by channel, but sensors are classified by “slot”. Since the initial slot number of the T12K is preset at each sensor, the sensors can be used as is by connecting them. There are 1~31 slots.

BASIC OPERATION

How to turn transmitter power ON/OFF

When turning on the power, the T12K transmitter will begin emitting RF automatically after it confirms the surrounding RF conditions.

The T12K transmitter also offers the ability to auto shutdown.

When turning on the power of the transmitter

First, make sure the throttle stick is in the low throttle position.

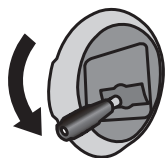

Push up to turn on.

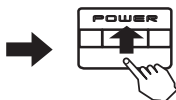

*If the throttle stick is not in the low position, you'll have an alarm until the stick is in the low position. (In the case of Multicopter mode, throttle position alarm does not occur.)

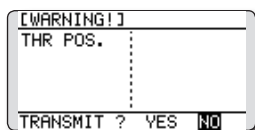

1. Turn on the power switch of the transmitter.

*The message "CHECK RF CONDITION" is displayed for a moment. At the same time, the LED monitor blinks.

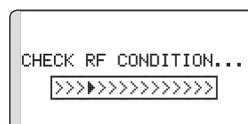

2. Then, you will see the home screen and the transmitter begins to emit radio waves.

How to stop the transmitter

1. Turn off the power switch of the transmitter.

*The transmitter shuts down at once.

Low battery alarm and auto shutdown

When the battery voltage reaches 5.6V, an audible alarm will sound. Land your aircraft immediately.

When the battery voltage reaches 4.0V, the transmitter will be turned off automatically.

*If you do not operate the transmitter (or move a stick, knob, switch, or digital trim) for 30 minutes, the message "PLEASE TURN OFF POWER SWITCH" is displayed and an audible alarm will sound.

User name registration

If desired, the T12K transmitter can indicate the owner's name.

User name setup screen

1. Turn on the power of the transmitter.

*The home screen appears.

2. Lightly push the SYS button twice rapidly and the System menu appears.

3. Select [USER NAME] in the System menu and push the RTN button.

*The user name set up screen appears.



Input Box

*Current user name is displayed.

Changing the user name

1. Change the user name as described below:

[Moving cursor in input box]

Select [←] or [→] and push the RTN button.

[Deleting a character]

When [DELETE] is selected and the RTN button is pushed, the character immediately after the cursor is deleted.

[Adding a character]

When a character is selected from the character list and the RTN button is pushed, that character is added at the position immediately after the cursor.

*A name up to 10 characters long can be entered as the user name. (A space is counted as one character.)

2. At the end of input, select [ENTER] and touch the RTN button. (To terminate input and return to the original state, select [CANCEL] and push the RTN button.)

Home Screen

Use the Push dial to select the following display area to call each setting screen, and push the RTN button. The setting screen appears.

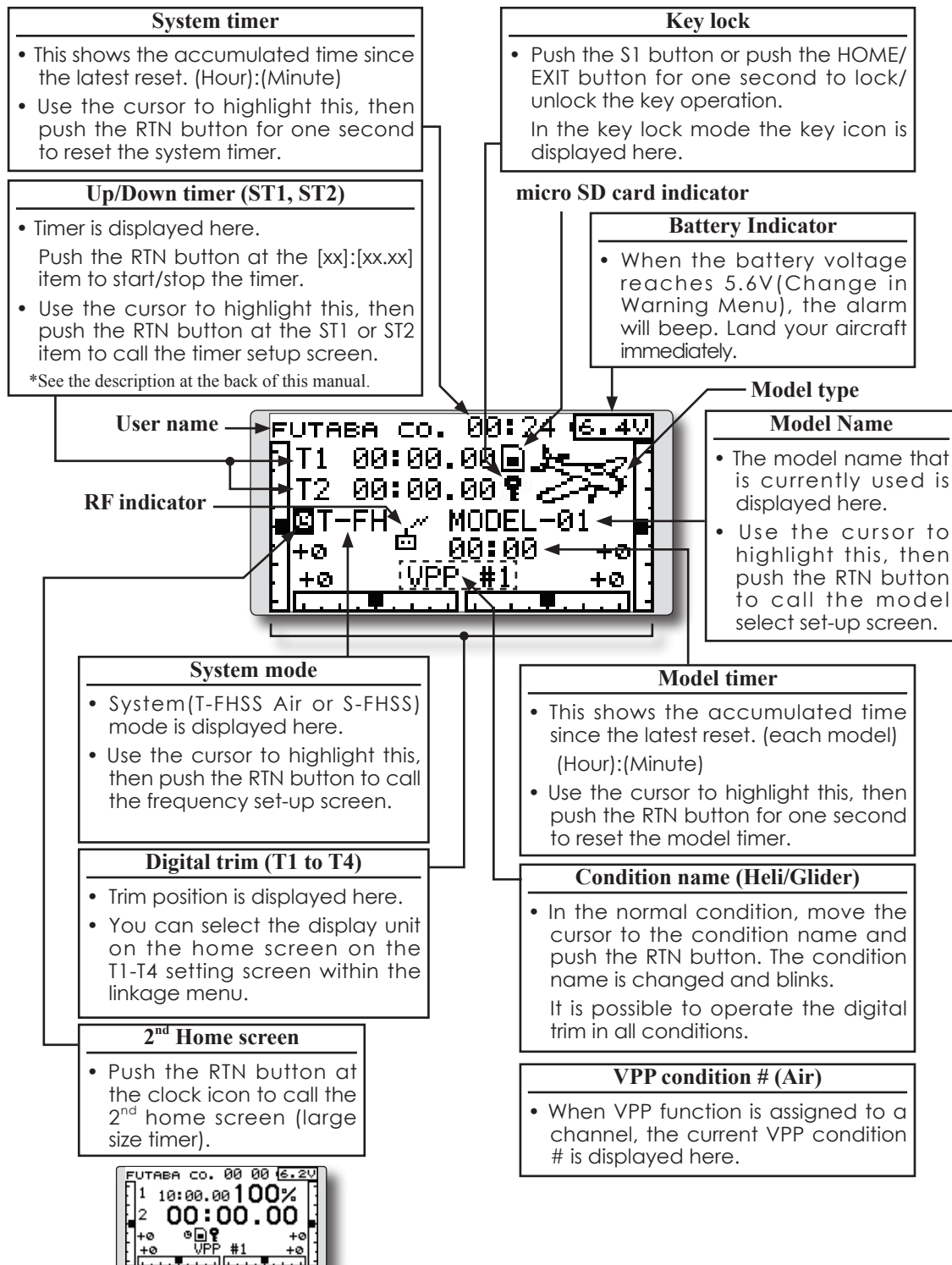

User Menu

A user menu which allows the user to customize and display frequently used functions.

1. When the "U.MENU" button is pushed for two seconds, the user menu appears.

*Return to the home screen by pushing the EXIT button while the user menu is being displayed.

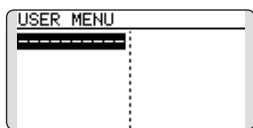

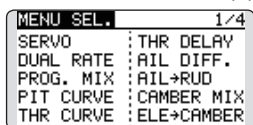

2. When the cursor highlights the dotted line, "-----" and the RTN button is pushed, the menu selection screen appears.



3. When the cursor is moved to the setting that you to set to the user menu and the RTN button is pushed, that setting screen is added to the user menu.
4. The registered setting screen can be called by moving the cursor to it and pushing the RTN button.

*When you want to delete an added screen from the user menu, highlight item you wish to delete, push and hold the RTN button for one second.

Warning

-  Be sure to confirm the model name before flying your aircraft.
-  Check the battery voltage as often as possible and try to charge the battery earlier. If the battery alarm makes a sound, land your aircraft immediately.

Link procedure T-FHSS Air (T12K/R3008SB)

Each transmitter has an individually assigned, unique ID code. In order to start operation, the receiver must be linked with the ID code of the transmitter with which it is being paired. Once the link is made, the ID code is stored in the receiver and no further linking is necessary unless the receiver is to be used with another transmitter. When you purchase additional R3008SB receivers, this procedure is necessary; otherwise the receiver will not work.

- 1 Place the transmitter and the receiver close to each other within a half (0.5m) meter.

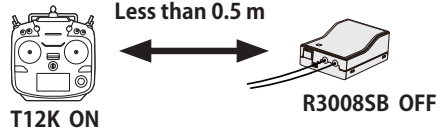

- 2 Set transmitter to link mode.

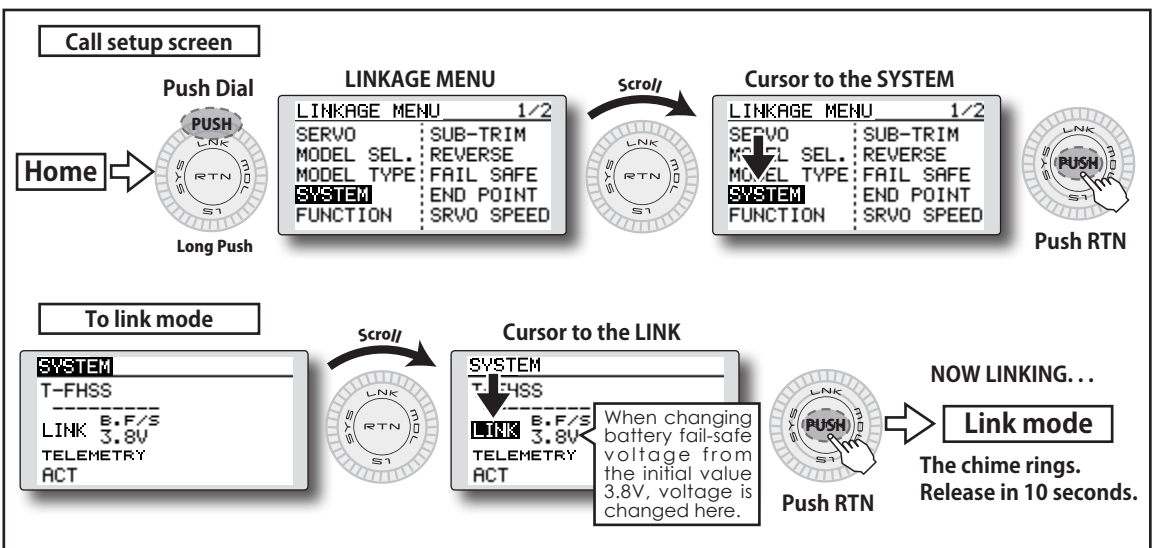

- 3 Immediately turn on the receiver power. The receiver will enter the linking state (LED blinks red) about 3 seconds after the receiver power is turned on.

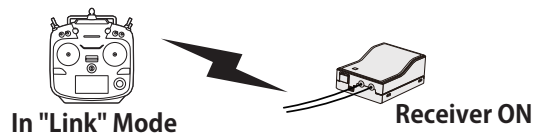

- 4 If the receiver ID is displayed in the transmitter and the LED changed from red blinking to a steady green light, linking is complete. (The receiver linking wait state ends in about 3 seconds.)

- 5 Check system operation. If the transmitter and receiver are not linked, try linking again.

*If there are many T-FHSS Air systems turned on in close proximity, your receiver might have difficulty establishing a link to your transmitter. This is a rare occurrence. However, should another T-FHSS Air transmitter/receiver be linking at the same time, your receiver could link to the wrong transmitter. This is very dangerous if you do not notice this situation. In order to avoid the problem, we strongly recommend you double check whether your receiver is really under control by your transmitter.

*When the power of the linked transmitter is turned on, communication begins.

*When using 2 receivers, perform the linking operation the same as the 1st receiver. (However, when 2 receivers are used, the telemetry system cannot be used.)

*Link is required when a new model is made from a model selection.

If the receiver's voltage does not display on the transmitter

- ◆ When the receiver has the transmitter's ID in memory, a link is established and normal operation is allowed.
- ◆ When the transmitter has the receiver's ID in memory, a link is established and telemetry functions are usable.

The transmitter stores receiver IDs by model; thus, if it does not have a particular receiver model ID stored in memory or has a different receiver ID stored, telemetry functions will be unusable. However, the device is operable as long as the receiver has the transmitter's ID stored in memory.

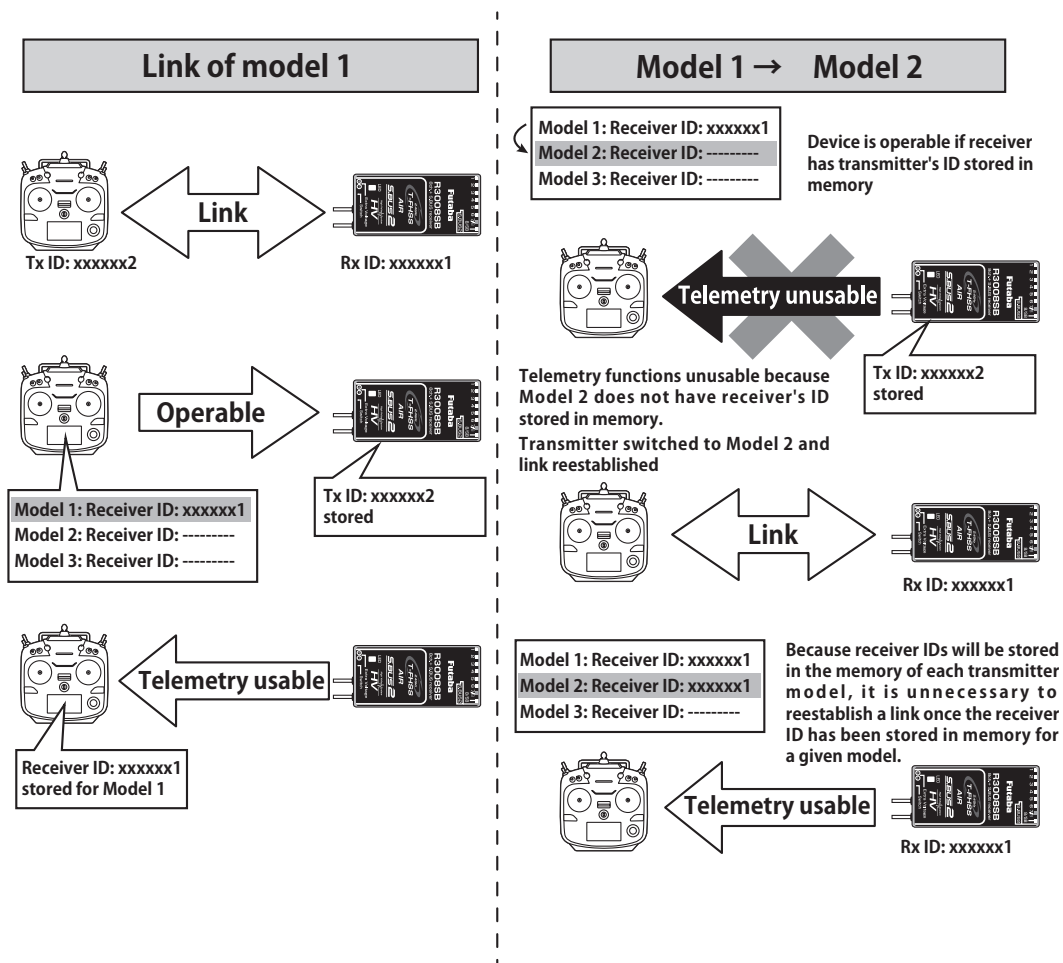

When setting up a new model, before using it, first establish a link with the receiver that will be used with it.

Link procedure S-FHSS (T12K/Optional S-FHSS receiver)

If the receiver of S-FHSS is used, the methods of a link differ.

- *When using an optional receiver, a link is necessary.
- *Follow the manual of the receiver to be used. Moreover, carry out an operating check.
- *Telemetry function cannot be used for the S-FHSS receiver.

Receiver link method in S-FHSS

- 1 Place the transmitter and the receiver close to each other within a half (0.5m) meter.

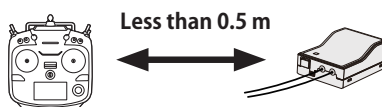

- 2 Turn on the transmitter.

- 3 Turn on the receiver.

- 4 Push and hold the Link switch more than two(2) seconds. When the link is complete, the LED in the receiver changes to solid green. When the ID cannot be read due to the surrounding environment, try reading it with the transmitter and receiver antennas pushed.



- 5 Check system operation. If the transmitter and receiver are not linked, try linking again.



*If there are many S-FHSS systems turned on in close proximity, your receiver might have difficulty establishing a link to your transmitter. This is a rare occurrence. However, should another S-FHSS transmitter/receiver be linking at the same time, your receiver could link to the wrong transmitter. This is very dangerous if you do not notice this situation. In order to avoid the problem, we strongly recommend you double check whether your receiver is really under control by your transmitter.

- *When the power of the linked transmitter is turned on, communication begins.
- *When using 2 receivers, perform the linking operation the same as the 1st receiver.

⚠ WARNING

❗ After the linking is done, please cycle receiver power and check that the receiver to be linked is really under the control of the transmitter.

⊘ Don't perform the linking procedure with the main motor wire connected or with the engine operating. Serious injury might occur.

Range Testing Your R/C System

It is extremely important to range check your models prior to each flying session. This enables you to ensure that everything is functioning as it should for maximum enjoyment from your flying time. The T12K transmitter incorporates a system that reduces its power output and allows you to perform such a range check.

Range check mode

We have installed a special "Range check mode" for doing a ground range check. To access the "Range check mode" touch and hold the RTN button while turning on the transmitter. Doing so will bring up POWER MODE menu.

First, Push to RTN. Next, Push up to turn on.

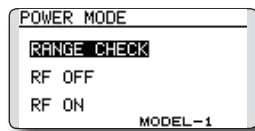
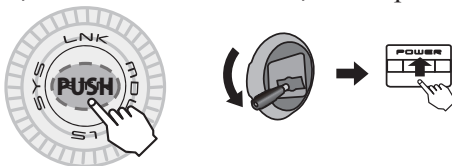

↑ The present model

To activate the "Range check mode" touch the RTN button and the range check mode screen will appear.

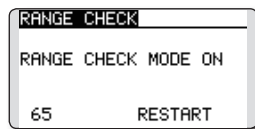

During this mode, the RF power output is reduced so the range test can be performed. In addition, when this mode is activated the LED on the front of the transmitter starts blinking and the transmitter gives users a warning with a beeping sound every 3 seconds.

The "Range check mode" continues for 90 seconds. After that, power will return to normal. To exit the "Range check mode" before 90 seconds, select "RANGE CHECK" at the top of the screen and touch the RTN button again. This mode is only available one time, so, if you need to reuse the function, transmitter power must be cycled. NEVER start flying when the "Range check mode" is active.

Should you require additional time to perform a range check, highlight Restart before your time expires and press the RTN button one time.

Range check procedure

1. With the "Range check mode" on, walk away from the model while simultaneously operating the controls. Have an assistant stand by the model to confirm that all controls are completely and correctly operational. You should be able to walk approximately 30-50 paces from the model without losing control.
2. If everything operates correctly, return to the model. Set the transmitter in a safe yet accessible location so it will be within reach after starting the engine or motor. Be certain the throttle stick is in the low throttle position, then start the engine or motor. Perform another range check with your assistant holding the aircraft with the engine running at various speeds. If the servos jitter or move inadvertently, there may be a problem. We would strongly suggest you do not fly until the source of the difficulty has been determined. Look for loose servo connections or binding pushrods. Also, be certain that the battery has been fully charged.

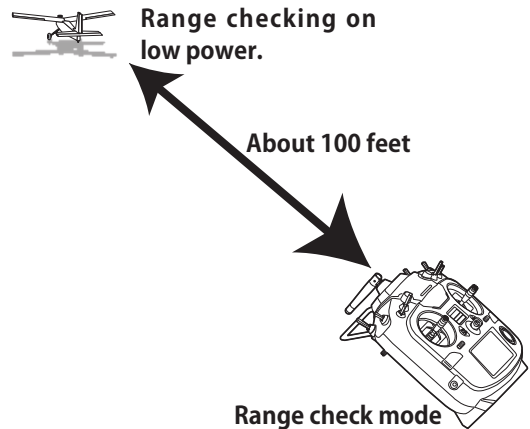

Warning

! Do not fly in range check mode.

*Since the range of the radio waves is short, if the model is too far from the transmitter, control will be lost and the model will crash.

Servo connection by model type

The T12K transmitter channels are automatically assigned for optimal combination according to the type selected with the Model Type function of the Linkage Menu. The channel assignment (initial setting) for each model type is shown below. Connect the receiver and servos to match the type used.

*The set channels can be checked at the Function screen of the Linkage Menu. The channel assignments can also be changed. For more information, read the description of the Function menu.

Airplane/glider

Normal wing and V-tail

R X CH	1Aileron		2Aileron		2Aileron+1FLAP		2Aileron+2FLAP		2Aileron+4FLAP		4Aileron+2FLAP		The output CH of each system
	Airplane	Glider	Airplane	Glider	Airplane	Glider	Airplane	Glider	Airplane	Glider	Airplane	Glider	
1	Aileron	Aileron	Aileron	Aileron	Aileron	Aileron	Aileron	Aileron	Aileron	Aileron	Aileron	Aileron	S-FHSS T-FHSS Air
2	Elevator	Elevator	Elevator	Elevator	Elevator	Elevator	Elevator	Elevator	Elevator	Elevator	Elevator	Elevator	
3	Throttle	Motor	Throttle	Motor	Throttle	Motor	Throttle	Motor	Rudder	Rudder	Rudder	Rudder	
4	Rudder	Rudder	Rudder	Rudder	Rudder	Rudder	Rudder	Rudder	Aileron2	Aileron2	Aileron2	Aileron2	
5	Gear	AUX7	Gear	AUX7	Gear	AUX6	Gear	AUX5	Flap	Flap	Aileron3	Aileron3	
6	VPP	AUX6	Aileron2	Aileron2	Flap	Flap	Aileron2	Aileron2	Flap2	Flap2	Aileron4	Aileron4	
7	AUX5	AUX5	VPP	AUX6	Aileron2	Aileron2	Flap	Flap	Flap3	Flap3	Flap	Flap	
8	AUX4	AUX4	AUX5	AUX5	VPP	AUX5	Flap2	Flap2	Flap4	Flap4	Flap2	Flap2	
9	AUX1	AUX1	Camber	Camber	Camber	Camber	Camber	Camber	Camber	Camber	Camber	Camber	
10	AUX1	AUX1	AUX1	Butterfly	AUX1	Butterfly	VPP	Butterfly	Gear	Butterfly	Gear	Butterfly	
11	AUX1	AUX1	AUX1	AUX1	AUX1	AUX1	AUX1	AUX1	Throttle	Motor	Throttle	Motor	
12	AUX1	AUX1	AUX1	AUX1	AUX1	AUX1	AUX1	AUX1	VPP	AUX1	VPP	AUX1	
DG1	SW	SW	SW	SW	SW	SW	SW	SW	SW	SW	SW	SW	
DG2	SW	SW	SW	SW	SW	SW	SW	SW	SW	SW	SW	SW	

Ailvator (Dual Elevator)

R X CH	1Aileron		2Aileron		2Aileron+1FLAP		2Aileron+2FLAP		2Aileron+4FLAP		4Aileron+2FLAP		The output CH of each system
	Airplane	Glider	Airplane	Glider	Airplane	Glider	Airplane	Glider	Airplane	Glider	Airplane	Glider	
1	Aileron	Aileron	Aileron	Aileron	Aileron	Aileron	Aileron	Aileron	Aileron	Aileron	Aileron	Aileron	S-FHSS T-FHSS Air
2	Elevator	Elevator	Elevator	Elevator	Elevator	Elevator	Elevator	Elevator	Elevator	Elevator	Elevator	Elevator	
3	Throttle	Motor	Throttle	Motor	Throttle	Motor	Throttle	Motor	Rudder	Rudder	Rudder	Rudder	
4	Rudder	Rudder	Rudder	Rudder	Rudder	Rudder	Rudder	Rudder	Aileron2	Aileron2	Aileron2	Aileron2	
5	Gear	AUX7	Gear	AUX7	Gear	AUX6	Elevator2	Elevator2	Flap	Flap	Aileron3	Aileron3	
6	VPP	AUX6	Aileron2	Aileron2	Flap	Flap	Aileron2	Aileron2	Flap2	Flap2	Aileron4	Aileron4	
7	Elevator2	Elevator2	Elevator2	Elevator2	Aileron2	Aileron2	Flap	Flap	Flap3	Flap3	Flap	Flap	
8	AUX4	AUX4	VPP	AUX5	Elevator2	Elevator2	Flap2	Flap2	Flap4	Flap4	Flap2	Flap2	
9	AUX1	AUX1	Camber	Camber	Camber	Camber	Camber	Camber	Camber	Camber	Camber	Camber	
10	AUX1	AUX1	AUX1	Butterfly	VPP	Butterfly	Gear	Butterfly	Gear	Butterfly	Gear	Butterfly	
11	AUX1	AUX1	AUX1	AUX1	AUX1	AUX1	VPP	AUX1	Throttle	Motor	Throttle	Motor	
12	AUX1	AUX1	AUX1	AUX1	AUX1	AUX1	AUX1	AUX1	Elevator2	Elevator2	Elevator2	Elevator2	
DG1	SW	SW	SW	SW	SW	SW	SW	SW	SW	SW	SW	SW	
DG2	SW	SW	SW	SW	SW	SW	SW	SW	SW	SW	SW	SW	

Airplane/glider

Flying wing, Delta wing

R X	2Aileron		2Aileron+1FLAP		2Aileron+2FLAP		2Aileron+4FLAP		4Aileron+2FLAP		The output CH of each system
	Airplane	Glider	Airplane	Glider	Airplane	Glider	Airplane	Glider	Airplane	Glider	
1	Aileron	Aileron	Aileron	Aileron	Aileron	Aileron	Aileron	Aileron	Aileron	Aileron	5-FHSS 1-FHSS Air
2	VPP	AUX4	VPP	AUX4	VPP	AUX4	Aileron2	Aileron2	Aileron2	Aileron2	
3	Throttle	Motor	Throttle	Motor	Throttle	Motor	Rudder	Rudder	Aileron3	Aileron3	
4	Rudder	Rudder	Rudder	Rudder	Rudder	Rudder	VPP	AUX4	Aileron4	Aileron4	
5	Gear	AUX7	Gear	AUX6	Gear	AUX6	Flap	Flap	Rudder	Rudder	
6	Aileron2	Aileron2	Flap	Flap	Flap	Flap	Flap2	Flap2	VPP	AUX4	
7	AUX6	AUX6	Aileron2	Aileron2	Aileron2	Aileron2	Flap3	Flap3	Flap	Flap	
8	AUX5	AUX5	AUX5	AUX5	Flap2	Flap2	Flap4	Flap4	Flap2	Flap2	
9	Elevator	Elevator	Elevator	Elevator	Elevator	Elevator	Elevator	Elevator	Elevator	Elevator	
10	Camber	Camber	Camber	Camber	Camber	Camber	Camber	Camber	Camber	Camber	
11	AUX1	AUX1	AUX1	Butterfly	AUX1	Butterfly	Gear	Butterfly	Gear	Butterfly	
12	AUX1	AUX1	AUX1	AUX1	AUX1	AUX1	Throttle	Motor	Throttle	Motor	
DG1	SW	SW	SW	SW	SW	SW	SW	SW	SW	SW	
DG2	SW	SW	SW	SW	SW	SW	SW	SW	SW	SW	

R X	2Aileron		2Aileron+1FLAP		2Aileron+2FLAP		2Aileron+4FLAP		4Aileron+2FLAP		The output CH of each system
	Airplane	Glider	Airplane	Glider	Airplane	Glider	Airplane	Glider	Airplane	Glider	
1	Aileron	Aileron	Aileron	Aileron	Aileron	Aileron	Aileron	Aileron	Aileron	Aileron	5-FHSS 1-FHSS Air
2	Rudder2	Rudder2	Rudder2	Rudder2	Rudder2	Rudder2	Aileron2	Aileron2	Aileron2	Aileron2	
3	Throttle	Motor	Throttle	Motor	Throttle	Motor	Rudder	Rudder	Aileron3	Aileron3	
4	Rudder	Rudder	Rudder	Rudder	Rudder	Rudder	Rudder2	Rudder2	Aileron4	Aileron4	
5	Gear	AUX7	Gear	AUX6	Gear	AUX6	Flap	Flap	Rudder	Rudder	
6	Aileron2	Aileron2	Flap	Flap	Flap	Flap	Flap2	Flap2	Rudder2	Rudder2	
7	VPP	AUX6	Aileron2	Aileron2	Aileron2	Aileron2	Flap3	Flap3	Flap	Flap	
8	AUX5	AUX5	VPP	AUX5	Flap2	Flap2	Flap4	Flap4	Flap2	Flap2	
9	Elevator	Elevator	Elevator	Elevator	Elevator	Elevator	Elevator	Elevator	Elevator	Elevator	
10	Camber	Camber	Camber	Camber	Camber	Camber	Camber	Camber	Camber	Camber	
11	AUX1	AUX1	AUX1	Butterfly	VPP	Butterfly	Gear	Butterfly	Gear	Butterfly	
12	AUX1	AUX1	AUX1	AUX1	AUX1	AUX1	Throttle	Motor	Throttle	Motor	
DG1	SW	SW	SW	SW	SW	SW	SW	SW	SW	SW	
DG2	SW	SW	SW	SW	SW	SW	SW	SW	SW	SW	

*Different systems have different output channels. A system with few channels will have wing types which cannot be used. If a function is outside of the range of the arrow for the system to the right of the figure above, that function cannot be used by that system.

Helicopter

CH	All Other	H-4, H4X Swash
1	Aileron	Aileron
2	Elevator	Elevator
3	Throttle	Throttle
4	Rudder	Rudder
5	Gyro/RUD	Gyro/RUD
6	Pitch	Pitch
7	Governor	Governor
8	Needle	Elevator2
9	Gyro2/AIL	Gyro2/AIL
10	Gyro3/ELE	Gyro3/ELE
11	AUX1	AUX1
12	AUX1	AUX1
DG1	SW	SW
DG2	SW	SW

The output
 CH of each
 system
 SFHSS
 TFHSS Air

Multicopter

CH	Multicopter
1	Aileron
2	Elevator
3	Throttle
4	Rudder
5	MODE
6	TILT
7	PAN
8	REC
9	AUX1
10	AUX1
11	AUX1
12	AUX1
DG1	SW
DG2	SW

The output
 CH of each
 system
 SFHSS
 TFHSS Air

MODEL BASIC SETTING PROCEDURE

Airplane/glider basic setting procedure

1. Model addition and selection

Initially, the T12K assigns the first model to model-01 in the transmitter. The Model Select function of the Linkage Menu is used to add models and to select amongst models which are already set.

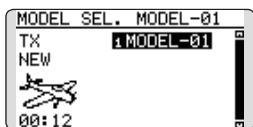

The T12K is capable of storing data for up to 30 models in its internal memory. Additional model data can also be saved to an optional micro SD card.

The currently selected model name is displayed in the center of the home screen. Before flying and before changing any settings, always confirm the model name.

When a new model is added, the Model type select screen and System mode setup screen automatically appear. Please be aware that the transmitter will stop transmitting temporarily when you change the model.

When a new model is added, you will need to re-link the receiver.

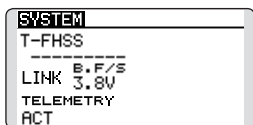
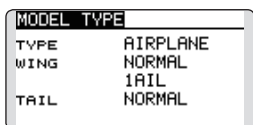

2. Model type selection

Select the model type matched to the aircraft with the Model Type select function of the Linkage Menu. For an airplane, select the model type from among the 2 types: airplane and glider. And then select the wing type and the tail type matched to the aircraft.

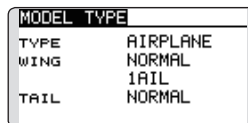

3. Fuselage linkage

Connect the ailerons, elevators, throttle, rudder, etc. in accordance with the model's instruction manual. For a description of the connection method, see the Receiver and Servos Connection.

Note that even for the same "airplane model", when the wing type and tail type are different, the channel assigned to each function can be different. (The channel assigned to each function can be checked at the Function menu of the Linkage Menu.)

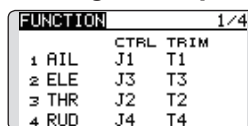

- If the direction of the servo is incorrect, adjust the direction with the Reverse function of the Linkage Menu.

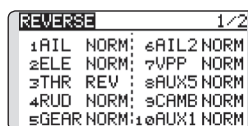

- Adjust the neutral position and control surface angle with the linkage, and fine tune them with the Sub-Trim and End Point functions (angle adjustment). To protect the linkage, a limit position can also be set with the End Point function. The End Point function can adjust the amount of up/down and left/right movement and limit of each channel.

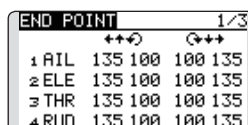
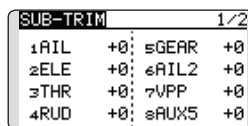

4. Throttle cut setting (Airplane)

Throttle cut can be performed with one push by a switch without changing the throttle trim position.

Set throttle cut with the Throttle Cut function of the Linkage Menu. After activating the throttle cut function and selecting the switch, adjust the throttle position so that the carburetor fully closes. For safety, the throttle cut function operates the throttle stick in the 1/3 or less (slow side) position.

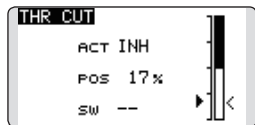

5. Idle down setting (Airplane)

The idling speed can be lowered with one push by a switch without changing the throttle trim position. Perform this setting with the Idle Down function of the Linkage Menu. After activating the Idle Down function and selecting the switch, adjust the idle down speed. For safety, the idle down function acts only when the throttle stick is in the lowest part of its throw.

*While the Throttle Cut function is in operation, the Idle Down function does not work.

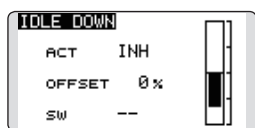

6. D/R function

D/R function is used to adjust the throw and operation curve of the stick functions (aileron, elevator, rudder, and throttle) for each switch position (airplane) or each flight condition (glider). This is normally used after the modeler has defined the maximum throw directions in the End Point settings.

(Airplane)

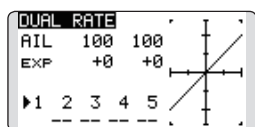

(Glider)

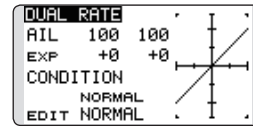

7. Airbrake (Airplane)

This function is used when an airbrake is necessary when taking off or diving, etc. Please note: this menu item is only available under certain wing configurations. For example, it will not appear if a single aileron wing type has been selected.

The preset elevator and flap offset amount can be activated by a switch.

The offset amount of the aileron, elevator, and flap servos can be adjusted as needed. Also, the speed of the aileron, elevator, and flap servos can be adjusted. You can also set the Auto Mode, which will link Airbrake to a stick, switch, or dial. A separate stick switch or dial can also be set as the ON/OFF switch.

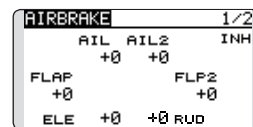

8. Addition of flight conditions (Glider)

The Condition Select function automatically allocates the normal condition (NORMAL) for each model. NORMAL is the default condition and is the only one active when a new model type is defined.

If you want to add flight conditions, please refer to a description of the CONDITION function.

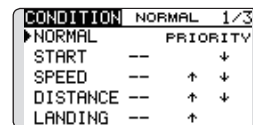

*The NORMAL is always on, and remains on until other conditions are activated by switches, stick positions, etc. Please refer to the section called Switch Selection Method for additional information on how to do so.

*It is possible to customize the activation of the flight conditions.

*The Condition Delay can be programmed for each channel. The Condition Delay is used to change the servo throw smoothly when switching conditions.

Helicopter basic setting procedure

This section outlines examples of use of the helicopter functions of the T12K. Adjust the actual values, etc. to match the fuselage used.

1. Model addition and selection

Initially, the T12K assigns the first model to model-01 in the transmitter. To add new models or to select a model already programmed, use the Model Select function of the Linkage Menu.

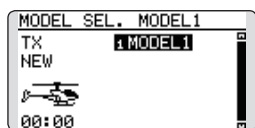

This is convenient when selecting a model after entering the model names in advance. The T12K is capable of storing up to 30 models in internal memory. Additional models can also be stored in an optional micro SD card.

The currently selected model is displayed in the middle of the screen. Before flying and before changing any settings, always confirm the model name.

When a new model is added, the Model Type select screen and system mode setup screen automatically appear. Change or check that they match the swash type and receiver type of the model used.

When a new model is added, you will need to re-link the receiver.

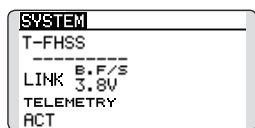
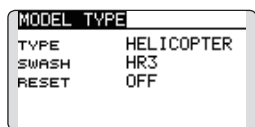

2. Model type and swash type selection

If a different model type is already selected, select helicopter with the Model Type function of the Linkage Menu, then select the swash type matched to the helicopter.

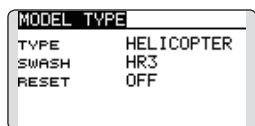

*The Model Type function automatically selects the

appropriate output channels, control functions, and mixing functions for the chosen model type. Six swash types are available for helicopters.

*For a description of the swash type selection, refer to the MODEL TYPE function.

3. Flight condition addition

The transmitter offers up to five flight conditions per model.

CONDITION	NORMAL	1/3
▶NORMAL		PRIORITY
IDLEUP1	SE	↓
IDLEUP2	SE	↑ ↓
IDLEUP3	SF	↑ ↓
HOLD	--	↑

The Condition Select function automatically allocates five conditions for helicopters.

(Initial setting)

- NORMAL
- IDLE UP1 (SW-E)
- IDLE UP2 (SW-E)
- IDLE UP3 (SW-F)
- HOLD (Hold switch is not assigned initially)

Note: Since you may accidentally activate previous flight conditions during a later flight and cause a crash, we suggest deleting unused conditions.

*For a description of condition deletion, refer to the Condition Select function.

The NORMAL condition is always on, and remains on until other conditions are activated by switches.

The priority is throttle hold/idle up 3/idle up 2/idle up 1/normal. Throttle hold has the highest priority.

The Condition Delay can be programmed for each channel and condition. The Condition Delay is used to change the servo throw smoothly when switching conditions.

(General flight condition setting example)

- Normal: (Use initial setting conditions/operate when switch OFF)
Use from engine starting to hovering.
- Idle up 1: (Operate at SW-E center)
Use in stall turn, loop, and other maneuvers.
- Idle up 2: (Operate at SW-E forward side)
Use in rolls.
- Throttle hold: (Operate at SW-G forward side)
Use in auto rotation.

4. Servo Connection

Connect the throttle rudder, aileron, elevator, pitch, and other servos in accordance with the kit instruction manual. For a description of the connection method, see "Receiver and Servos Connection".

Note: The channel assigned to each function can be checked at the Function menu of the Linkage Menu.

FUNCTION	NORMAL	1/4
	CTRL TRIM	
1 AIL	J1	T1 SEPAR
2 ELE	J3	T3 SEPAR
3 THR	J2	T2 SEPAR
4 RUD	J4	T4 SEPAR

- If the direction of operation of the servo is incorrect, use the Reverse function of the Linkage Menu. Also use the swash AFR function in other than the H-1 mode.

THR CURVE	NORMAL	1/3
EDITNORMAL	COPY	
>5	100.0 (100)	
>4	75.0 75.0	
>3	50.0 50.0	
>2	25.0 25.0	
>1	0.0 (0)	

SWASH	AFR	1/5
NEUTRAL		
POS 50%	AIL +50%	
	ELE +50%	
	PIT +50%	

- Adjust the direction of operation of the gyro. (Gyro side function)
- Connect the throttle linkage so that the carburetor can fully close at full trim throttle cut.
- Adjust the neutral position at the linkage side and fine tune with the Sub-Trim function and End Point function. To protect the linkage, a limit position can also be set with the End Point function.

SUB-TRIM		1/2
1 AIL	+0	5GYRO +0
2 ELE	+0	6PIT +0
3 THR	+0	7GOV +0
4 RUD	+0	8NDL +0

END POINT		1/3
1 AIL	135 100	100 135
2 ELE	135 100	100 135
3 THR	135 100	100 135
4 RUD	135 100	100 135

- Swash plate correction (Except H-1 mode)
 - *If any interactions are noticed, for a description of the linkage correction function, please refer to the SWASH function.

5. Throttle/Pitch curve setting

This function adjusts the throttle or pitch operation curve in relation to the movement of the throttle stick for each condition.

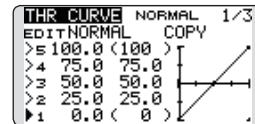

<Throttle curve setting example>

Activate the throttle curve of each condition with the condition select switch.

- Normal curve adjustment
Normal curve creates a basic throttle curve centered near hovering. This curve is adjusted together with the pitch curve (Normal) so that the engine speed is constant and up/down control is easiest.
- Idle up curve adjustment
The low side Throttle curve creates a curve matched for aerobatics (loop, roll, 3D, etc.).
- Throttle hold curve adjustment
Confirm that the rate of the slowest position (0%) of the stick is 0% (initial setting).

<Example of pitch curve setting>

Activate the pitch curve of each condition with the condition select switch.

- Pitch curve (Normal)
Make the pitch at hovering approximately +5°~6°. Set the pitch at hovering with the stick position at the 50% point as the standard.
*Stability at hovering may be connected to the throttle curve. Adjustment is easy by using the hovering throttle function and hovering pitch function together.
- Pitch curve (Idle up 1)
The idle up 1 pitch curve function creates a curve matched to airborne flight. Set to -7°~+12° as standard.
- Pitch curve (Idle up 2)
The high side pitch setting is less than idle up 1. The standard is +8°.
- Pitch curve (Hold)
At auto rotation, use the maximum pitch at both the high and low sides.
[Pitch angle setting example]
Throttle hold: -7°~+12°

6. D/R function

D/R function is used to adjust the throw and operation curve of aileron, elevator and rudder for each condition.

*For throttle and pitch curve settings, refer to the aforementioned "Throttle/Pitch curve setting"

This is normally used after End Point has defined the maximum throw directions.

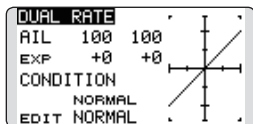

7. Gyro sensitivity and mode switching

The gyro sensitivity and mode switching function is utilized to adjust the gyro mixing of the model, and can be set for each condition.

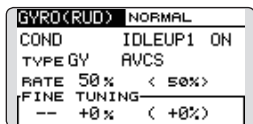

- Normal condition (hovering): Gyro sensitivity maximum
- Idle up 1/Idle up 2/Throttle hold: Gyro sensitivity minimum
- However, during auto rotations with a tail-driven helicopter, this function may not have any effect on the high gyro sensitivity.

8. Pitch to RUD mixing setting

Note: When using a Futaba GY Gyro, or other heading hold gyro, this Pitch to RUD mixing should not be used. The reaction torque is corrected by the gyro. When operating the gyro in the AVCS mode, the mixed signal will cause neutral deviation symptoms and the gyro will not operate normally.

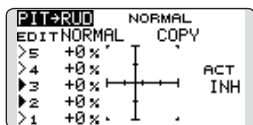

Use this function when you want to suppress the torque generated by the changes in the pitch and speed of the main rotor during pitch operation. Adjust it so that the nose does not swing in the rudder direction. However, when using a heading hold gyro like those shown above, do not use Pitch to rudder mixing.

Activate the Pitch to rudder (Pit -->RUD) mixing function from the Model Menu, and set the curve for each condition. (At initial setting, this function is in the "INH" state. To use it, set it to the "ON" state.)

<Setting example>

Activate the mixing curve of each condition with the condition select switch.

A curve setting example is shown below.

- Pitch to RUD mixing curve (Normal)
Use the hovering system and set this curve to match take off and landing and vertical climb at a constant speed.
- Pitch to RUD mixing (Idle up 1)
Use this curve in stall turn, loop, and adjust it so the fuselage is facing straight ahead when heading into the wind.
- Pitch to RUD mixing (Hold)
This function is set so that the fuselage is facing straight ahead at straight line auto rotation. The pitch of the tail rotor becomes nearly 0°.

9. Throttle hold setting

*If throttle hold is necessary, please refer to the THR HOLD function.

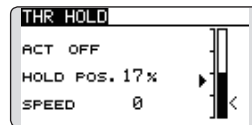

10. Throttle cut setting

Throttle cut provides an easy way to stop the engine, by flipping a switch with the throttle stick at idle. The action is not functional at high throttle to avoid accidental dead sticks. Switch location and direction must be chosen, as it defaults to NULL.

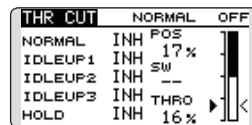

*With throttle stick at idle, adjust the cut position until the engine consistently shuts off, but throttle linkage is not binding.

11. Swash Mix corrects aileron, elevator, and pitch interaction

The swash mix function is used to correct the swash plate in the aileron (Left/Right Cyclic) and elevator (Forward/Aft Cyclic) direction corresponding to each operation of each condition.

SWASH MIX NORMAL 1/2		
EDIT		
NORMAL	RATE1	RATE2
AIL→ELE	+0%	+0%
ELE→AIL	+0%	+0%
PIT→AIL	+0%	+0%
PIT→ELE	+0%	+0%

12. Throttle mixing setting

*If throttle mixing is necessary to compensate for engine slowing caused by swash plate operation during aileron or elevator operation, please refer to the THROTTLE MIX function.

THR MIX NORMAL 1/2		
EDIT		
NORMAL	RATE1	RATE2
AIL→THR	+0%	+0%
ELE→THR	+0%	+0%
RUD→THR	+0%	+0%

13. Other special mixes

- Pitch to Needle mixing
This mixing is used with engines with a design which allows needle control during flight (fuel-air mixture adjustment). A needle curve can be set.
- Governor mixing
This mixing is dedicated governor mixing when a governor is used.

SYSTEM MENU

The System Menu sets up functions of the transmitter: This does not set up any model data.

- Call the system menu shown below by long pushing the SYS button at the home screen, etc.

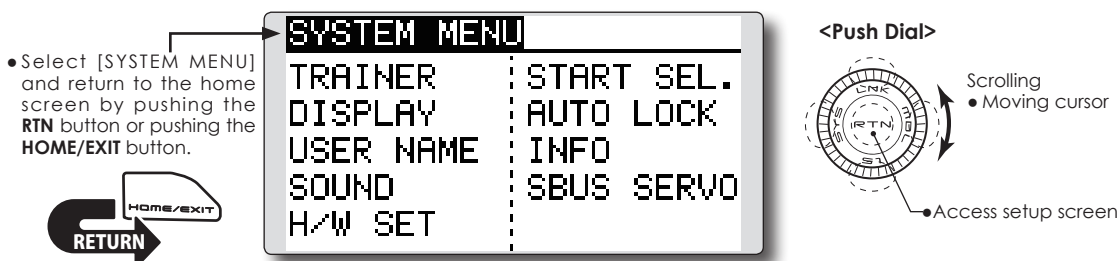

- Select the function you want to set and call the setup screen by pushing the RTN button.

System Menu functions table

[TRAINER]: Starts and sets the trainer system.

[DISPLAY]: LCD and backlight adjustment.

[USER NAME]: User name registration.

[SOUND]: Turns off the buzzer.

[H/W SET]: H/W reverse, calibration, and stick mode.

[START SEL.]: Immediately, a model selection can be performed.

[AUTO LOCK]: The automatic lock function of two kinds of push dials.

[INFO]: Displays the program version, micro SD card information, product ID, and language selection.

[SBUS SERVO]: S.BUS servo setting.

T12K trainer system makes it possible for the instructor to choose which channels and operation modes can be used in the student transmitter. The function and rate of each channel can be set. The training method can also be matched to the student's skill level. Two transmitters must be connected by an optional Trainer Cord. The instructor's transmitter should be programmed for trainer operation, as described below.

When the instructor activates the trainer switch, the student has control of the aircraft (if MIX/FUNC/NORM mode is turned on, the Instructor can make corrections while the student has control). When the switch is released, the instructor regains control. This is very useful if the student gets the aircraft into an undesirable situation.

- Setting data are stored to model data.
- Student rate can be adjusted at MIX/FUNC/NORM mode.
- Activated student channels can be selected by switches.

NOTE: This trainer system can be used in the following ways:

1. With the T12K and a conventional transmitter, you must match the channel order on the two transmitters before using the trainer function.

You can select the channel of input data from the student transmitter in the "FUNC" or "MIX" mode.

2. When the T12K is used as the instructor transmitter, set the modulation mode of the student's transmitter to PPM.

If used as the student, T12K can be connected to the instructor transmitter, which must be set to PPM mode. T12K always uses the PPM mode to send or receive signals through the trainer jack.

(In the case of non-2.4GHz student transmitters.)

3. Be sure that all channels work correctly in both transmitters before flying.

Corresponding types of transmitters and trainer mode settings:

Types of transmitters		Instructor's transmitter settings		Student's transmitter settings			Trainer Cords
Instructor	Student	System Type	Trainer setting	System Type	Trainer setting		
		Mod. mode	CH mode	Mod. mode	CH mode	Mod. mode	
T12K/T14SG/ T16SZ/T18SZ/ T18MZ	T12K/T14SG/ T16SZ/T18SZ/ T18MZ	Arbitrary	16CH	Arbitrary	16CH	-	T12FG (FUTM4405) and 9C (FUTM4415) Trainer Cords
T12K	T14MZ, FX-40, T12Z, T12FG, FX-30	Arbitrary	12CH	PCM-G3 2.4G	12CH	PPM	
T12K	T8FG, FX-20	Arbitrary	12CH 8CH	FASST-MLT2 FASST-MULT	-	-	
T12K	T10C, T9C, T7C, T6EX, T4EX	Arbitrary	8CH	PPM	-	-	T12FG (FUTM4405)
T12K	T10CG, T7C	Arbitrary	8CH	Arbitrary	-	-	T12FG (FUTM4405)
T12K	T8J, T6K, T6J	Arbitrary	8CH	Arbitrary	-	-	T12FG (FUTM4405) and 9C (FUTM4415) Trainer Cords
T14MZ, FX-40, T12Z, T12FG, FX-30	T12K	Arbitrary	12CH	Arbitrary	12CH	-	
T8FG, FX-20	T12K	Arbitrary	12CH	Arbitrary	12CH	-	
T10C, T10CG, T9C, T7C, T7C, T8J, T6K, T6J	T12K	Arbitrary	-	Arbitrary	8CH	-	

- Select [TRAINER] in the System menu and enter the setup screen shown below by pushing the RTN button.

• Select the function name and return to the System menu by pushing the RTN button or pushing the HOME/EXIT button.

INH	MODE	RATE	STU.	CH
1 AIL	OFF			
2 ELE	OFF			
3 THR	OFF			
4 RUD	OFF			

Mode and switch selection

1. Access the setup screen page 4 shown below by pushing the S1 button three times.

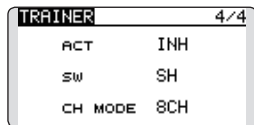

2. Move the cursor to the [ACT] or [16/12/8CH] item and push the RTN button to switch to the data input mode.
3. Select the mode by scrolling the Push dial. The display blinks. Push the RTN button to change the mode. (To terminate the mode change, push the S1 button.)

"ACT": Enable operation by changing to [OFF] or [ON].

"16/12/8 CH": When the student uses the T12K, T14SG, T16SZ, T18SZ, T18MZ, select [16CH]. When the student uses the T14MZ, T12Z, T12FG or FX-40, select [12CH]. Otherwise select [8CH].

If changing the trainer switch:

4. Move the cursor to the [SW] item and push the RTN button to access the switch setup screen.

(See "Switch selection method" at the end of this manual for selection method details.)

"SW": Select the desired switch.

Initial setting: SH

*The switch mode can also be selected when setting the ON position on the switch setup screen. When [ALTERNATE OFF] is selected, normal ON/OFF operation is performed. When [ALTERNATE ON] is selected, the trainer function

is alternately turned on and off each time the switch is operated. This allows alternate ON/OFF switching even when a momentary switch (SH) is used.

Note: The trainer function won't be turned on unless the instructor transmitter receives signals from the student transmitter. Be sure to confirm this after connecting your trainer cable.

Operating mode selection

(Setup screen page 1-3)

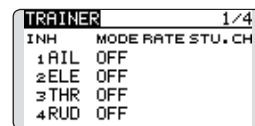

1. Move the cursor to the [MODE] item of the channel you want to change and push the RTN button to switch to the data input mode.
2. Select the mode by scrolling the Push dial. The display blinks. Push the RTN button to change the mode. (To terminate the mode change, push the S1 button.)

"MODE": Select the desired operation mode for each channel.

NORM: The model is controlled by signals from the student transmitter.

MIX mode: The model is controlled by signals from the instructor and student transmitters. (Reset the student's model data to the default condition.)

FUNC mode (function mode): The model is controlled by signals from the student transmitter with the instructor's setting. (Reset the student's model data to the default condition.)

OFF: Only the instructor side operates.

Adjusting the student's rate.

*This can be adjusted for students who may need lower rates than a more experienced student.

1. Move the cursor to the [RATE] item of the channel you want to change and push the RTN button to switch to the data input mode.
2. Adjust the rate by scrolling the Push dial.

"RATE": Adjust the desired rate.

Setting range: 0~100%

Initial value: 100%

*When you want to reset the value to the initial state, push the RTN button for one second.

3. To end adjustment, push the RTN button and return to the cursor mode.

Changing the student's channel

*The setting above allows setting of the channel assignment of student side when [MIX] or [FUNC] was selected.

1. Move the cursor to the [STU. CH] item of the channel you want to change and push the RTN button to switch to the data input mode.
2. Select the channel by scrolling the Push dial. The display blinks. Push the RTN button to change the channel. (To terminate the mode change, push the S1 button.)

"STU. CH": Match the channel order of the Instructor's and student's transmitter. This function will help if both transmitters are in different modes, or the Master has a different wing type set up. The student can be set to match the Master without any physical changes being made.

In case of MULTIROTOR type

- The default settings of TRAINER at MULTIROTOR are below. It is easy to set TRAINER when the student radio is used for camera gimbal control.

TRAINER		1/4
INH	MODE RATE STU. CH	
1 RIL	OFF	
2 ELE	OFF	
3 THR	OFF	
4 RUD	OFF	

TRAINER		2/4
INH	MODE RATE STU. CH	
5 MODE	OFF	
6 TILT FUNC	100% CH3	
7 PAN FUNC	100% CH4	
8 REC FUNC	100% CH5	

TRAINER		3/4
INH	MODE RATE STU. CH	
9 AUX1	OFF	
10 AUX1	OFF	
11 AUX1	OFF	
12 AUX1	OFF	

TRAINER		4/4
ACT	INH	
SW	--	
CH MODE	8CH	

*Please do not use REVERSE, END POINT, or any other mixes at student transmitter.

DISPLAY

LCD contrast, backlight brightness, and backlight off timer adjustment are possible.

You can also set your units to either the metric system or standard.

- Select [DISPLAY] at the system menu and access the setup screen shown below by pushing the RTN button.

• Select the function name and return to the System menu by pushing the RTN button or pushing the HOME/EXIT button.

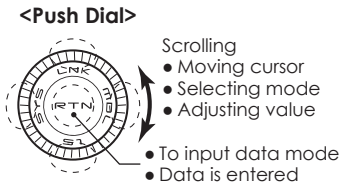
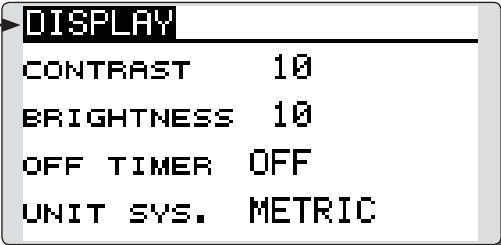

<Push Dial>

Scrolling

- Moving cursor
- Selecting mode
- Adjusting value

• To input data mode

• Data is entered

LCD contrast adjustment

1. Select "CONTRAST" and push the RTN button to switch to the data input mode and adjust the contrast by scrolling the Push dial.

"CONTRAST": Adjust the contrast to the desired value while watching the screen display.

Setting range: (Lighter) 0 to 15 (Darker)

Initial value: 5

*When you want to reset the value to the initial state, push the RTN button for one second.

2. Push the RTN button to end adjustment and return to the cursor mode.

Backlight brightness adjustment

1. Select "BRIGHTNESS" and push the RTN button to switch to the data input mode and adjust the backlight brightness by scrolling the Push dial.

"BRIGHTNESS": Adjust the brightness to the desired value while watching the screen display.

Setting range: OFF, 1 to 20(Lighter)

Initial value: 10

*When you want to reset the value to the initial state, push the RTN button for one second.

2. Push the RTN button to end adjustment and return to the cursor mode.

Back-light off-timer

1. Select "OFF TIMER" and push the RTN button to switch to the data input mode and adjust the backlight off timer by scrolling the Push dial.

"OFF TIMER": Adjust the time when the backlight turns off after operating the Push dial.

Setting range: 10 to 240 sec (each 10 sec), OFF (always on)

Initial value: 10 sec

*When you want to reset the value to the initial state, push the RTN button for one second.

2. Push the RTN button to end adjustment and return to the cursor mode.

Unit system adjustment

1. Select "UNIT SYS." and push the RTN button to switch to the data input mode and adjust the unit by scrolling the Push dial.

Setting range: (METRIC) or (YARD/POUND)

2. Push the RTN button to end adjustment and return to the cursor mode.

USER NAME

User name registration

This function allows the modelers to change the T12K user name.

*A name of up to 10 characters can be entered as the user name. Please note that a space is counted as one character.

- Select [USER NAME] at the System menu and access the setup screen shown below by pushing the RTN button.

• Select the function name and return to the System menu by pushing the RTN button or pushing the HOME/EXIT button.

User name (candidate)

<Push Dial>

- Scrolling
- Moving cursor
- Data is entered
- To next page

User name registration

1. Change the user name as described below:

[Moving cursor in user name (candidate)]

Select [←] or [→], and push the RTN button.

[Deleting a character]

When [DELETE] is selected and the RTN button is pushed, the character immediately after the cursor is deleted.

[Adding a character]

When a character is selected from the character list and the RTN button is pushed, that character is added at the position immediately after the cursor.

*A name of up to 10 characters long can be entered as the user name. (A space is counted as 1 character.)

2. Upon completing the input, select [ENTER] and push the RTN button. (To terminate input and return to the original state, select [CANCEL] and push the RTN button.)

(Character list 1/3)

USER NAME	1/3
FUTABA_CO.	ABCDEFGHIJ
	KLMNOPQRST
CANCEL	UWXYZabcd
ENTER	efghijklmn
← →	OPQRSTUWVX
DELETE	yz !"#%&\'

(Character list 2/3)

USER NAME	2/3
FUTABA_CO.	:0123456789
	.,:;+*~/^
CANCEL	<>=?@[]^.
ENTER	*`0úéáàáááá
← →	éééééééééééé
DELETE	éééééééééééé

(Character list 3/3)

USER NAME	3/3
FUTABA_CO.	:アイエオカキク
	サシスセソチツト
CANCEL	:ナニホヘヒフヘ
ENTER	:マミヤメヨ
← →	:ラリレロカキク
DELETE	:アイエオカキク

SOUND

Turns off the buzzer.

The warning sound and other sounds of the T12K transmitter can be turned off.

*When "WARNING" is set to OFF, the no operation alarm (30 minutes), mixing warning sound, and low battery alarm sounds are turned off.

- Select [SOUND] at the system menu and access the setup screen shown below by pushing the RTN button.

• Select the function name and return to the System menu by pushing the RTN button or pushing the HOME/EXIT button.

<Push Dial>

- Scrolling
 - Moving cursor
 - Selecting mode
 - Adjusting value
- To input data mode
- Data is entered
- To next page

On/off operation

1. Move the cursor to the [TIMER][WARNING] or [OTHER SOUND] item and push the RTN button to switch to the data input mode.
2. Select ON or OFF by scrolling the Push dial.
3. Push the RTN button.

- Telemetry data is announced over headphones. There are two pages of settings for it.

Vario melody volume →

Phone volume (Telemetry etc.) →

This is a hardware for phone volume Vario.

This is a operation mode for the phone volume Vario Melody.

This is a operation mode for the phone volume except Vario Melody.

This is a hardware for phone volume except Vario.

SOUND 2/2 VARIO MELODY

This is the volume of Vario Melody only.
 Setting range : 0 (silent) ~ 30 (maximum)
 The hardware for the adjustment is selectable.
 Setting range : J1, J2, J3, J4, T1, T2, T3, T4, SA, SB, SC, SD, SE, SF, SG, SH, LS, LD, RD, RS
 The operation mode of the adjustment hardware is selectable.

ATL+ : When the operation direction is right or down or C.W. , the volume is increased.
ATL- : When the operation direction is right or down or C.W. , the volume is decreased.
SYM. : The center position is minimum volume. Both end points are maximum volume.



ATL+ ATL- SYM.

H/W SETTING

Hardware reverse and stick mode

H/W reverse

This function reverses the operation direction of the sticks, switches, trim levers, and knobs.

Note: This setting reverses the actual operation signal, but does not change the display indicators. Use the Normal mode as long as there is no special reason to use the Reverse mode.

Stick mode

This function changes the stick mode of transmitter.

Note: This will not change the throttle ratchet, etc. Mechanical changes must be performed by a Futaba service center.

Note: After changing the mode, these changes are only applied to new models. It is not applied to an existing model.

Stick calibration

J1-J4 stick correction can be performed.

- Select [H/W SET] at the system menu and access the setup screen shown below by pushing the RTN button.

• Select the function name and return to the System menu by pushing the RTN button or pushing the HOME/EXIT button.

Operation direction reversal method

1. Select [H/W REVERSE] and access the setup screen shown below by pushing the RTN button.

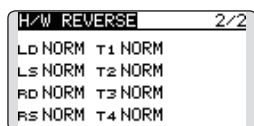
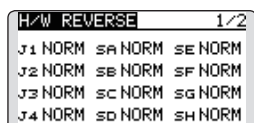

2. Move the cursor to the item corresponding to the H/W (hardware) you want to reverse and push the RTN button to switch to the data input mode.
3. Select the mode by scrolling the Push dial. The display blinks. When the RTN button is pushed, the operation direction is reversed. (To terminate the mode change, push the S1 button.)

"NORM": Normal operation direction

"REV" : Operation direction is reversed.

Changing stick mode

1. Select [STICK MODE] and access the setup screen shown below by pushing the RTN button.

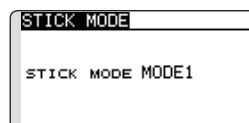

2. Move the cursor to the "STICK MODE" item and push the RTN button to switch to the data input mode.
3. Select the mode. The display blinks. When the RTN button is pushed, the stick mode is changed. (To terminate the mode change, push the S1 button.)

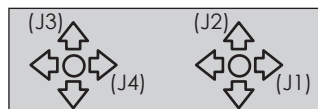

Mode	J1	J2	J3	J4
1	Aileron	Throttle	Elevator	Rudder
2	Aileron	Elevator	Throttle	Rudder
3	Rudder	Throttle	Elevator	Aileron
4	Rudder	Elevator	Throttle	Aileron

Stick calibration method

*J3 and J4 correction is described below. J1 and J2 corrections are performed using the same procedure.

1. Select [CALIBRATION] and access the setup screen shown below by pushing the RTN button.

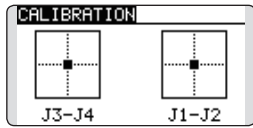

2. Move the cursor to the J3-J4 button and push the RTN button.

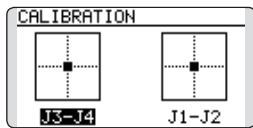

3. Move the J3 or J4 sticks to the neutral position and push the RTN button for one second.

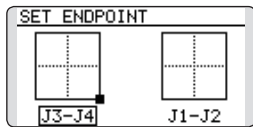

4. Set the J3 and J4 sticks fully to the bottom right and wait until the buzzer sounds.

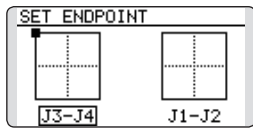

5. Set the J3 and J4 sticks fully to the top left and wait until the buzzer sounds.

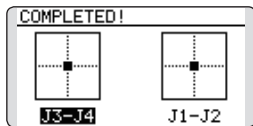

6. The above completes the correction operation. Operate and check if stick correction was performed normally.

START SEL.

Immediately, a model selection can be performed

START SEL can perform a model selection immediately on startup. This is convenient for modelers who fly two or more models with a single transmitter.

Quick Select Screen



As the name suggests, the Quick Model Select Function enables the modeler to change the selected models rapidly each time the transmitter is turned ON. With a few quick pushes, it is possible to change models whereas before it would require

a multi-step process. The T12K stores up to four models in the Quick Select offerings.

Model Select Screen

When the transmitter is turned on, it will open to the Model Selection Screen immediately.

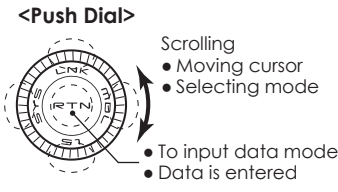
- Select the function name and return to the System menu by pushing the RTN button or pushing the HOME/EXIT button.



Setting Up and Adjusting the Quick Select Models

1. The Start Selection (START SEL.) menu is accessed through the T12K System Menu. Turn the transmitter ON and then push the SYS (System) button two times. Use the Push Dial to highlight the Start Selection (START SEL.) and then push the Return (RTN) button to confirm the selection.

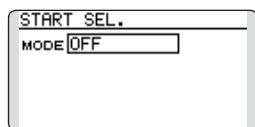

2. The Start Selection (START SEL.) menu option defaults to OFF, meaning that Quick Select and Model Select are not applicable. To activate the Quick Select or Model Select, use the Push Dial to scroll to the OFF setting as denoted in the image. With the OFF indication highlighted, push the Return (RTN) button and rotate the Push Dial once again to scroll amongst the options. With the Quick Select (QUICK SEL.) indicated, push the Return (RTN) button once again to make the desired selection as indicated.

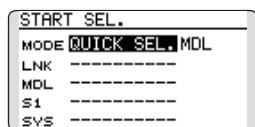

activated, there are two additional options available for customization: ALWAYS and MDL (Model). These options determine if/when the Quick Select information will appear on-screen. ALWAYS, as the name suggests, indicates that each time the transmitter is powered-up, the Quick Select information will appear on-screen. The MDL (Model) setting indicates that the Quick Select information will appear on-screen only when the MDL button is pushed simultaneously as the transmitter is turned ON. With the Quick Select mode highlighted, use the Push Dial to move to the activation setting options. Model (MDL) is the default setting. Push the Return (RTN) button to open the options, then scroll to the ALWAYS setting using the Push Dial pad. Push the Return (RTN) button once again to finalize the selection.

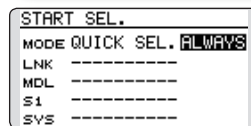
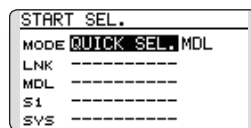

Quick Select Activation:

With the Quick Select (QUICK SEL.) option

Assigning models to the sensor buttons:

There are four sensors/buttons that correspond with the Push Dial: Link (LNK), Model (MDL), System (SYS), and S1. As such, it is possible to offer up to four models available through the Quick Select function. We suggest using the models that you fly most often.

1. Using the Push Dial, scroll to the desired sensor/button for the first model, for example, Link (LNK).
2. With the input next to the desired sensor highlighted, push the Return (RTN) button one time.
3. Using the Push Dial, scroll through the available models. To select the desired model, push the Return (RTN) button.
4. Repeat as desired for the remaining sensors.

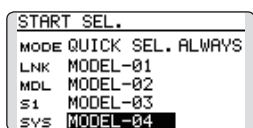

Using the sensors to select the model:

1. Turn ON the transmitter, activating the Quick Select screen. If Model (MDL) has been selected, please be sure to push the Model (MDL) sensor when powering up the transmitter.

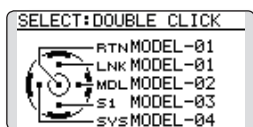

*Please note: Even if the Quick Select function is active, the Power Mode screen will appear when the transmitter is turned ON while simultaneously pushing the Return (RTN) button.

2. To select the model assigned to a particular sensor, double-click the desired sensor. For example, MODEL-03 is assigned to S1, double-click S1 to open all settings, etc. for Model-03. The T12K offers an audible and visual confirmation as the selected model memory is changed accordingly.

*Double clicking the Return (RTN) button selects the model that was selected the last time the transmitter was used. The currently selected model is indicated on the display.

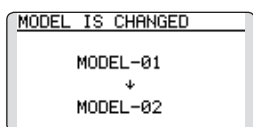

Model Select Screen

This allows the Model Select screen to be accessed immediately upon turning ON the transmitter.

*Please note: this function cannot be utilized at the same time as the Quick Select function. If more than four models are flown regularly, we suggest that the Model Select function be utilized as it will save time when selecting the desired aircraft. If four, or fewer, models are flown, the Quick Select option would be the best choice.

*Please note: the Model Select function does not allow access to the RENAME, COPY, or DELETE options. To use one of these options, access the Model Select screen.

1. The Start Selection (START SEL.) menu is accessed through the T12K's System Menu. Turn the transmitter ON and then push the SYS (System) button two times. Use the Push Dial to highlight the Start Selection (START SEL.) and then push the Return (RTN) button to confirm the selection.

2. The Start Selection (START SEL.) menu option defaults to OFF meaning that Quick Select and Model Select are not applicable. To activate the Quick Select or Model Select, use the Push Dial to scroll to the OFF setting as denoted in the image. With the OFF indication highlighted, push the Return (RTN) button and rotate the Push Dial once again to scroll to the Model Select (MODEL SEL.). Push the Return (RTN) button once again to activate Model Select as indicated.

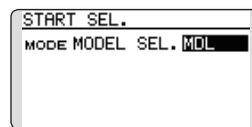

Model Select Activation:

With the Model Select (MODEL SEL.) option activated, there are two additional options available for customization: ALWAYS and MDL (Model). These options determine if/when the Model Select information will appear on-screen. ALWAYS, as the name suggests, indicates that each time the transmitter is powered-up, the Model Select information will appear on-screen. The MDL (Model) setting indicates that the Model Select information will appear on-screen only when the MDL button is pushed simultaneously as the transmitter is turned ON.

With the Model Select mode highlighted, use the

Push Dial to move to the activation setting options. Model (MDL) is the default setting. Push the Return (RTN) button to open the options, then scroll to the ALWAYS setting using the Push Dial pad. Push the Return (RTN) button once again to finalize the selection.

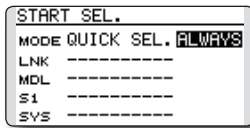
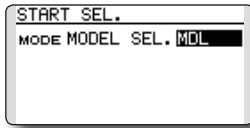

Using the Model Select Function:

1. Turn ON the transmitter, activating the Model Select screen. If Model (MDL) has been selected, please be sure to push the Model (MDL) sensor when powering up the transmitter.
 *Please note: Even if the Model Select function is active, the Power Mode screen will appear when the transmitter is turned ON while simultaneously pushing the Return (RTN) button.
2. The Push Dial is used to select amongst the on-screen models. The current model will automatically be highlighted when the transmitter is turned ON. If a different model is desired, use the Push Dial to scroll through the available options; each highlighted accordingly. Again, to select a model, push the Return (RTN) button accordingly. The T12K offers an audible and visual confirmation as the selected model memory is changed.

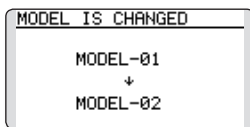
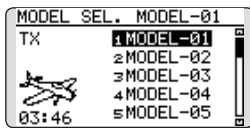

AUTO LOCK

The automatic lock function of two kinds of Push Dial

The Auto Lock function makes it possible to lock the transmitter to prevent any unwanted input from your hands while flying.

The auto lock function can be set in two ways.

LOCK TIMER

Auto Lock functions automatically when there is no operation from the HOME screen display for a chosen number of seconds.

START LOCK

Auto Lock functions automatically when the model changes or power is turned on.

*To temporarily allow access to the T12K programming push and hold the S1 or HOME/EXIT button for one second. Please note, the Auto Lock function timer will resume immediately once again.

● **Manual lock**
If **HOME/EXIT** button is pushed **1** second or more from a **HOME** screen, a **Push Dial** locks manually.

● **Manual lock**
If **S1** button is pushed **1** second or more from a **HOME** screen, a **Push Dial** locks manually.

● Select the function name and return to the System menu by pushing the **RTN** button or pushing the **HOME/EXIT** button.

<Push Dial>

- Scrolling
- Moving cursor
- Selecting mode
- Adjusting value

- To input data mode
- Data is entered

Auto lock method

1. Open the Auto lock screen in the system menu.

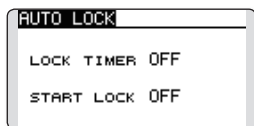

2. Adjust the activation timer for the Auto Lock function. The timer will begin counting immediately when the HOME screen is not used. The timer is adjustable in one second increments, up to 30 seconds. If the timer value is OFF, this function is not applicable.

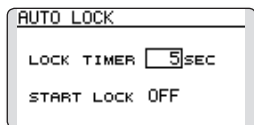

3. The Start Lock setting will, if enabled, automatically lock the T12K when the transmitter is powered up. To allow access to the transmitter's functions, push and hold the S1 key for one second.

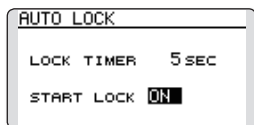

● **Lock release**
Every lock function's push [**1** second or more] of **S1** button will **release** the lock.

● **Lock release**
Every lock function's push [**1** second or more] of **HOME/EXIT** button will **release** the lock.

● **Display of a lock**
If locked, there will be sound and the **icon of a key** will come out.

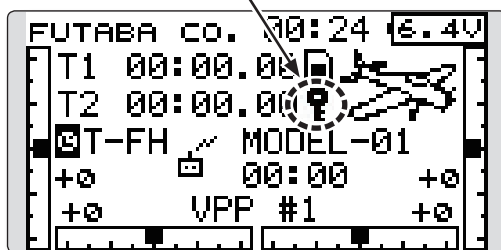

*If neither the Lock Timer or Start Lock functions are active (OFF), then the key lock remains even if the power is turned off.

*If the Lock Timer is enabled and the Start Lock is off, the key lock status is canceled each time the T12K is turned on.

⚠ Danger

❗ It is recommended to Lock the Push Dial during flight to prevent any accidental pushes which could change settings and cause an accident.

INFO

Displays the program version, micro SD card information, and product ID.

The T12K system program version information, micro SD card information (current and maximum number of model data and other files), and product ID are displayed on the Information screen.

The language displayed in home, menu, and setup screen is selectable.

*When the micro SD card is not inserted, the micro SD card information is not displayed.

- Select [INFO] at the system menu and access the setup screen shown below by pushing the RTN button.

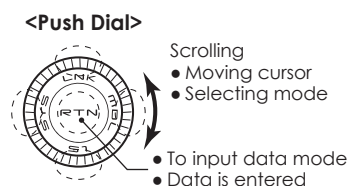

Information

"PRODUCT": Product ID number

"RF ID": RF ID number

"LANGUAGE": The language used in T12K

"VERSION": T12K system program version information

"AREA": Area which can use T12K

"CARD SIZE": Current/Maximum number of model data and other files (micro SD card)

Language selection

1. Move the cursor to the "LANGUAGE" item and push the RTN button to switch to the data input mode.
2. Change the language by scrolling the Push dial. The display blinks. When the RTN button is pushed, the language is changed. (To terminate the change, turn the EDIT dial or push the S1 button.)

*Telemetry speech is in English or Japanese.

*The telemetry speech and the version of installed speech data can be confirmed on the "TELEM.SET." screen.

*After updates, there is a possibility that a language changes. Readjust a language in that case.

Language table

Choose from these files.

Version No.	Selectable language		
Ver.1.0	English	Japanese	German
Ver.1.0A	English	Dutch	French
Ver.1.0B	English	Spanish	Czech
Ver.1.0C	English	Russian	Italian

SBUS SERVO

SBUS servo setting.

An S.BUS servo can memorize the channel and various settings you input. Servo setting can be performed on the T12K screen by wiring the servo as shown in the figure.

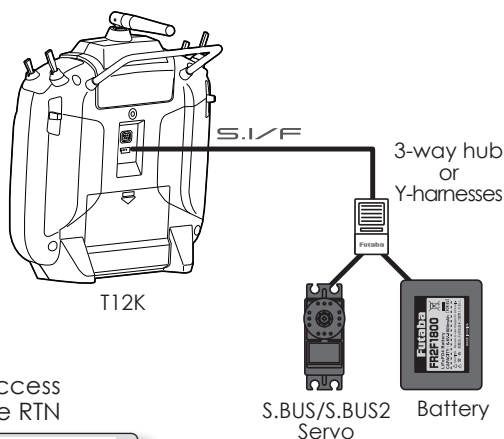

- Select [SOUND] at the system menu and access the setup screen shown below by pushing the RTN button.

- Select the function name and return to the System menu by pushing the RTN button or pushing the HOME/EXIT button.

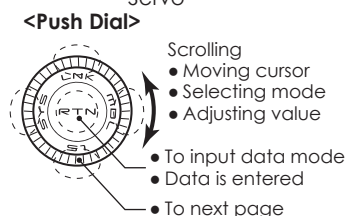
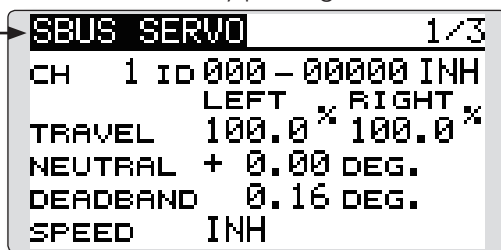

Servo ID number

Individual ID numbers are memorized for your S.BUS(2) servos in your T12K. When a servo is used, the servo ID number is automatically read by the transmitter. If you use multiple S.BUS(2) servos and do not want to change the settings on all that are mounted in a fuselage, only the desired servo in the group can be set by entering the ID of that specific servo.

* With some S.BUS(2) servos, there are some functions which cannot be used. If a function cannot be used, the display screen will change.

(Only the function which can be used by a servo is displayed.)

* After reading completion, with connection of the above figure, if a stick is moved, the test of operation of the servo can be operated and carried out.

Procedure for changing S.BUS servo setting

1. Select [SBUS SERVO] of the System Menu.
2. Wire the servo as shown in the figure above.
3. Push [RECALL] on page 3(\$1 is pushed twice). The ID and current setting of that servo are displayed. ([RECALL] is chosen ⇒ RTN is pushed ⇒ RTN is pushed for 1 second)
4. When multiple servos are connected change [INH] at the right side of the ID number on the screen to [ACT] and enter the ID of the servo you want to set.
5. Set each item. (Please see the next page.)
6. Push [WRITE] on page 3([WRITE] is chosen ⇒ RTN is pushed ⇒ RTN is pushed for 1 second). The settings are changed.

Push [INIT.], if you would like to initialize a setup of a servo. ([INIT.] is chosen ⇒ RTN is pushed ⇒ RTN is pushed for 1 second)

SBD-1 CH setting

CH setting of SBD-1 is available.

The **SBD-1** (option) is a converter for using conventional servos (other than **S.BUS** servo) with the **S.BUS** system.

1. Connect the SBD-1 and the battery to S.I/F port with 3 ways hub or Y harness.
2. Select S.BUS SERVO menu in SYSTEM menu.
3. Move to page 3/3.
4. Operate RECALL button. (RECALL is chosen. ⇒ RTN is pushed. ⇒ RTN is pushed for 1 second.) SBD-1 setting screen is shown.

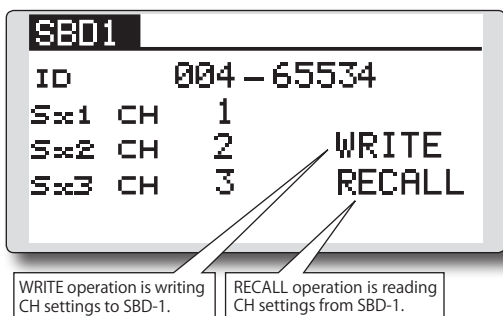

5. Set CH to each port of SBD-1. (SX1, SX2 and SX3)
* Setting range : CH1 ~ CH12, DG1, DG2
6. Operate WRITE button. (WRITE is chosen. ⇒ RTN is pushed. ⇒ RTN is pushed for 1 second.)
7. The settings are changed.
8. When the WRITE operation is successful, the message "COMPLETED" is shown.
9. When the WRITE operation fails, the message "FAILED" is shown.

S.BUS Servo Description of function of each parameter

*Certain functions will only be available with specific types of servo.

- **ID**

Displays the ID of the servo whose parameters are to be read. It cannot be changed.

- **Channel**

Channel of the S.BUS system assigned to the servo. Always assign a channel before use.

- **Reverse**

The direction in which the servo rotates can be changed.

- **Servo type**

- **Normal:** Normal operation mode

- **Retract:** Retract servo mode. When a load is applied to the servo for 30 seconds without any channel operation performed from the transmitter, the current consumption is suppressed by widening the dead band to 40°. When channel operation is performed from the transmitter, or the servo is moved outside the expanded dead band by an outside force, dead band expansion is reset and returns to the original operation.

- **O.L.P. :** This is the OverLoad Protection mode. If the servo is stalled for more than 5 seconds by a load, the servo output is turned off to protect the servo.

(Note)The S3171SB, S9071SB, S9072SB, S9074SB and S9075SB cannot utilize the Overload Protection mode.

OLP setting

When the servo type is OLP mode, the torque and time for OLP can be set. When the load is greater than this setting torque and continues over this setting time, OLP works.

<Trq>

This is the torque for working OLP.

Setting range : 10% ~ 100% (100% is the maximum torque of the servo which you are setting.)

<TIME>

This is the time for working OLP.

Setting range : 0.2, 0.5, 1, 2, 3, 4, 5, 6, 7, 8, 9, 10, 15, 20, 25, 30 sec

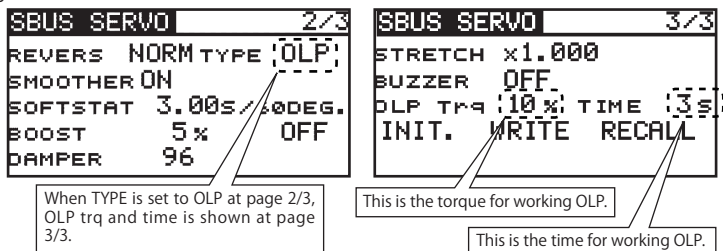

*If the setting of OLP torque and time is decreased, it is easier to engage OLP. Please be careful not to set OLP to operate under normal running conditions.

- **Soft Start**

Restricts operation in the specified direction the instant the power is turned on. By using this setting, the first initial movement when the power is turned on slowly moves the servo to the specified position.

- **Stop Mode**

The state of the servo when the servo input signal is lost can be specified. The "Hold" mode setting holds the servo in its last commanded position even if using AM or FM system.

- **Smoother**

This function changes smoothness of the servo operation relative to stick movement changes. Smooth setting is used for normal flight. Select the "OFF" mode when quick operation is necessary such as 3D.

- **Neutral Offset**

The neutral position can be changed. When the neutral offset is large, the servo's range of travel is restricted on one side.

• Speed Control

Speeds can be matched by specifying the operating speed. The speed of multiple servos can be matched without being affected by motor fluctuations. This is effective for load torques below the maximum torque.

However, note that the maximum speed will not exceed what the servo is capable of even if the servos operating voltage is increased.

• Dead band

The dead band angle at stopping can be specified.

[Relationship between dead band set value and servo operation]

Small → Dead band angle is small and the servo is immediately operated by a small signal change.

Large → Dead band angle is large and the servo does not operate at small signal changes.

(Note) If the dead band angle is too small, the servo will operate continuously the current consumption will increase, and the life of the servo will be shortened.

• Travel Adjust

The left and right travels centered about the neutral position can be set independently.

• Boost

The minimum current applied to the internal motor when starting the servo can be set. Since a small travel does not start the motor, it essentially feels like the dead band was expanded. The motor can be immediately started by adjusting the minimum current which can start the motor.

[Relationship between boost set value and servo operation]

Small → Motor reacts to a minute current and operation becomes smooth.

Large → Initial response improves and output torque increases. However, if the torque is too large, operation will become rough.

• Boost ON/OFF

OFF : Boost activates only when operating at low speed.

ON : Boost is always on to increase operating speed.

• Damper

The characteristic when the servo is stopped can be set.

When smaller than the standard value, the characteristic becomes an overshoot characteristic. If the value is larger than the standard value, the brake is applied before the stop position.

When large loads are applied, servos may be pushed by inertia and hunting may occur. If "hunting" (servo oscillation) occurs, even though the Dead Band, Stretcher, Boost, and other parameters are suitable, adjust the damper value up.

[Relationship between damper set value and servo operation]

Small → When you want to overshoot. Set so that hunting does not occur.

Large → When you want to operate so that braking is not applied. However, it will feel like the servo response has worsened.

(Note) If used in the hunting state, not only will the current consumption increase, but the life of the servo will also be shortened.

• Stretcher

The servo hold characteristic can be set. The torque which attempts to return the servo to the target position when the current servo position has deviated from the target position can be adjusted.

This is used when stopping hunting, etc., but the holding characteristic changes as shown below.

[Relationship between stretcher and servo operation]

Small → Servo holding force becomes weaker.

Large → Servo holding force becomes stronger.

(Note) When this parameter is large, the current consumption increases.

• **Buzzer**

When a servo power is turned on before a transmitter is connected, a buzzer sounds at 2.5Hz from the servo.

(It is not unusual for a servo buzzer to continue, even if a transmitter is disconnected, if the signal from the servo is not normal.)

If the transmitter is turned off before the servo power supply a buzzer sounds at 1.25Hz for the servo power supply end failure alarm.

(Do not insert or remove the servo connector while the receiver power is ON. A buzzer may sound by incorrect recognition.)

* Buzzer sound is generated by vibrating the motor of a servo.

Sounding a buzzer consumes current and produces heat. Do not operate the unit or allow a buzzer to sound for a long time.

FUNCTIONS OF LINKAGE MENU

The Linkage Menu is made up of functions which perform model addition, model type selection, system type, end point setting, and other model basic settings.

The functions which can be selected depend on the model type. A typical menu screen is shown below.

- Call the Linkage menu shown below by long pushing the LNK button at the home screen, etc.

- Select the function name and return to the Linkage menu by pushing the RTN button or pushing the HOME/EXIT button.

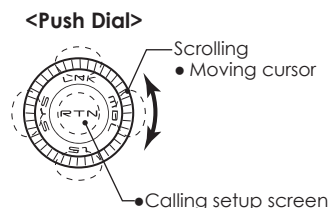
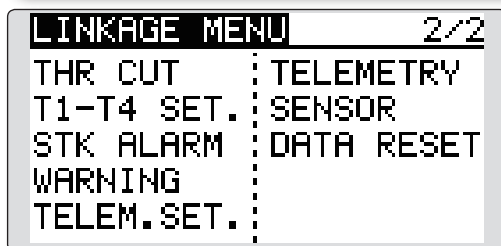
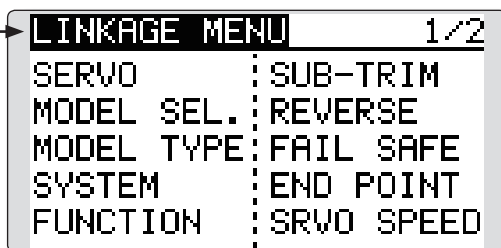

- Select the function you want to set and call the setup screen by pushing the RTN button.

*The display screen is an example. The screen depends on the model type.

Linkage Menu functions table

- [SERVO]: Displays the servo test and operation position.
- [MODEL SEL.]: Model addition, call, deletion, copy, model name setting.
- [MODEL TYPE]: Model type, wing type, swash type, etc. selection.
- [SYSTEM]: System mode selection, link of a transmitter and receiver, area mode selection.
- [FUNCTION]: Channel assignment of each function can be changed.
- [SUB-TRIM]: Adjusts the neutral position of each servo.
- [REVERSE]: Reverses the servo travel direction.
- [FAIL SAFE]: Fail safe function and battery fail safe function setting.
- [END POINT]: Servo travel adjustment and limit setting.
- [SERVO SPEED]: Speed setup of a servo.
- [THR CUT]: Stops the engine safely and easily (airplane and helicopter only).
- [IDLE DOWN]: Lowers the idle speed of the engine (airplane only).
- [SWASH RING]: Limits the swash plate travel to within a fixed range. (helicopter only).
- [SWASH]: Swash AFR and linkage correction function (helicopter only).
- [T1-T4 SET.]: Control step amount and mode selection of the digital trim.
- [STK ALARM]: An alarm can be sounded at the specified stick position.
- [WARNING]: Mixing warning normal reset.
- [TELEM.SET.]: Telemetry speech Ver./Telemetry data log /Telemetry alarm duration and repeat time.
- [TELEMETRY]: Displays various data sent from the receiver.
- [SENSOR]: Various telemetry sensors setting.
- [DATA RESET]: Model memory set data reset.

SERVO MONITOR Servo Test & Graph Display / Displays servo positions.

This is used for testing servo movement. “Moving Test” (repetition mode) and “Neutral Test” (fixed position mode) are available.

The “Neutral Test” is good for finding the neutral position of a servo horn.

In order to prevent any potential difficulties, the servo test function will be inoperable, or inaccessible, under certain conditions. Specifically, the Servo Test function is not operational if the throttle cut is ON in either airplane or helicopter modes; or if the throttle hold is ON in helicopter mode.

- A [U.MENU/MON.] button is pushed once from a home screen.
- Select [SERVO] in the Linkage menu and access the setup screen shown below by pushing the RTN button.

- Select the function name and return to the Linkage menu by pushing the RTN button or pushing the HOME/EXIT button.

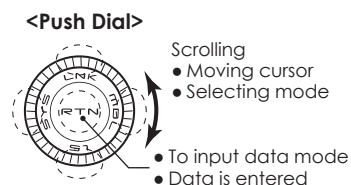
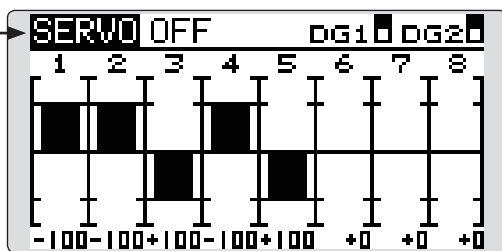

Servo test operation

1. Move the cursor to the [OFF] item and push the RTN button to switch to the data input mode.

Select the test mode by scrolling the Push dial and push the RTN button. The display blinks. Push the RTN button to change the mode. (To terminate mode change, push the S1 button.)

[MOVING]: Mode which repeats operation of each servo

[NEUTRAL]: Mode which locks each servo in the neutral position

2. Move the cursor to the [MOVING] or [NEUTRAL] item and push the RTN button to switch to the data input mode.

Select the [OFF] by scrolling the Push dial and push the RTN button. Testing is stopped.

MODEL SELECT

The Model Selection function performs model addition, selection, deletion, copy, and model name setting.

This function is used to load the settings of the desired model into the T12K's memory.

The settings may be selected from either the transmitter's internal memory or a micro SD card. Remember that up to 30 model memories are available in the transmitter.

The name of the model stored in the transmitter and the micro SD card may be changed. This can be very useful to tell different models settings apart. Each model name can be as long as 10 characters, and the model name always appears in the display screen.

The Copy function is used to copy parameters, settings, etc. from one model data into a second memory. It may be used for getting a head-start on setting up models with almost the same settings (only differences need to be modified, instead of entering the complete model from scratch). Also, this function may be used to make a backup copy of a model setup before any changes are made.

- Select [MODEL SELECT] in the Linkage menu and access the setup screen shown below by pushing the RTN button.

- Select the function name and return to the Linkage menu by pushing the RTN button or pushing the HOME/EXIT button.

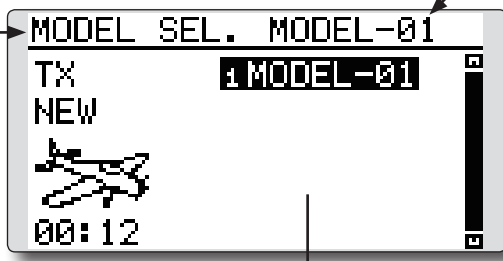

(Model list)

Current model

<Push Dial>

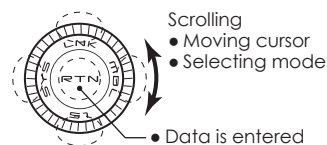

*The display screen is an example. The screen depends on the model type.

Model selection

*Model data saved on the transmitter memory other than the model currently used can be selected.

1. Move the cursor to the save destination display ("TX" or "CARD") and push the RTN button to switch to the data input mode. Select the save destination by scrolling the Push dial and push the RTN button.
[TX]: Transmitter memory
[CARD]: micro SD card
2. After moving the cursor to the desired model in the model list, push the RTN button.
3. Move to [SELECT].
4. Push the RTN button. A confirmation message is displayed. Push the RTN button for one second and selection is complete.

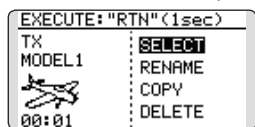

*Transmission stops and then starts in the new model.

Model addition

*A new model can be added to the transmitter memory. It cannot be added to the micro SD card.

1. Move the cursor to [NEW].
2. Push the RTN button. A confirmation message appears. Push the RTN button for one second.



*The model type setup screen and frequency setup screen are automatically displayed. Confirm or change the model type and SYSTEM mode.

*Transmission stops and then starts in the new model.

*The added model appears in the model list of the model select setup screen.

***Link is required when a new model is made from a model selection.**

Model deletion

*The model stored in the transmitter memory or a micro SD card can be deleted.

*The current model cannot be deleted.

1. Move the cursor to the save destination display ("TX" or "CARD") and push the RTN button to switch to the data input mode.

Select the save destination by scrolling the Push dial and push the RTN button.

[TX]: Transmitter memory

[CARD]: micro SD card

2. Move the cursor to the model you want to delete in the model list and then push the RTN button.
3. Move the cursor to [DELETE].
4. Push the RTN button. When a confirmation message is displayed and the RTN button is pushed for one second, the model is deleted.

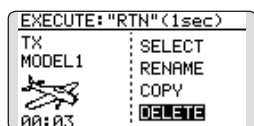

Model name change

*The model name of the model stored in the transmitter memory or a micro SD card can be changed.

1. If changing the location:

Move the cursor to the save destination display ("TX" or "CARD") and push the RTN button to switch to the data input mode.

Select the save destination by scrolling the Push dial and push the RTN button.

[TX]: Transmitter memory

[CARD]: micro SD card

2. Move the cursor to the model you want to change in the model list and then push the RTN button.
3. Move to [RENAME].
4. Push the RTN button.

*The model name setup screen is displayed.

User name (candidate)



5. Change the model name as described below:

[Moving cursor in the user name (candidate)]

Select [←] or [→], and push the RTN button.

[Deleting a character]

When [DELETE] is selected and the RTN button is pushed, the character immediately after the cursor is deleted.

[Adding a character]

When a character is selected from the character list and the RTN button is pushed, that character is added at the position immediately after the cursor.

*A name of up to 10 characters long can be entered as the model name. (A space is also counted as one character.)

6. After the desired information has been input, select [ENTER] and push the RTN button. (To terminate input and return to the original state, select [CANCEL] and push the RTN button.)

Model copy

*A copy can be made of the model stored in the transmitter memory or a micro SD card.

1. If changing the location:

Move the cursor to the save destination display ("TX" or "CARD") and push the RTN button to switch to the data input mode.

Select the save destination by scrolling the Push dial and push the RTN button.

[TX]: Transmitter memory

[CARD]: micro SD card

2. Select the model you want to copy in the model list and then push the RTN button.
3. Move to [COPY].
4. Push the RTN button.

*The copy screen appears.

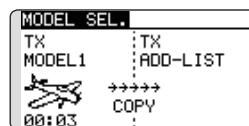

5. If replacing the model stored in the transmitter memory:

Move to [ADD-LIST] and push the RTN button to switch to the data input mode.

Select the destination model by scrolling the Push dial and push the RTN button.

[ADD-LIST]: adding the model to the list

[(model name)]: replacing the model

*The model stored in the micro SD card can be replaced.

If changing the location:

Move the cursor to the copy destination display ("TX" or "CARD") and push the RTN button to switch to the data input mode.

Select the save destination by scrolling the Push dial and push the RTN button.

6. Move to [COPY].
7. Push the RTN button. When a confirmation message is displayed and the RTN button is pushed for one second, the model data is copied.

MODEL TYPE

This function selects the model type from among multirotor, airplane, helicopter, and glider.

Six swash types are available for helicopters. Six types of main wings and three types of tail wings are available for airplanes and gliders. Functions and mixing functions necessary for each model type are set in advance at the factory.

Note: The Model Type function automatically selects the appropriate output channels, control functions, and mixing functions for the chosen model type.

When the Model Type selection command is accessed, all of the data in the active memory is cleared (except the following swash type.) Be sure that you don't mind

losing this data, or back it up to another memory using the copying functions.

When changing the helicopter swash type within the following groups, you can leave the settings other than the SWASH function. However, this is initialized when you change the swash type to the other swash type group.

Swash type group A: H-1, H-3, HR3, and HE3 Swash type group B: H-4, H-4X

- Select [MODEL TYPE] in the Linkage menu and access the setup screen shown below by pushing the RTN button.

- Select the function name and return to the Linkage menu by pushing the RTN button or pushing the HOME/EXIT button.

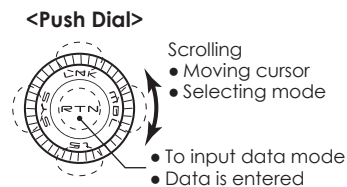

(The display screen is an example. The screen depends on the model type.)

Model type selection

1. Move the cursor to the item you want to change and push the RTN button to switch to the data input mode.

Select the desired type by scrolling the Push dial and push the RTN button. A confirmation message appears. Push the RTN button for one second.

Move to [YES] and Push the RTN button for one second.

(To terminate input and return to the original state, push the S1 button or select [NO] and push the RTN button.)

"TYPE": Model type

"WING " (airplane/glider): Wing type

"TAIL" (airplane/glider): Tail type

"SWASH" (helicopter): Swash type

2. If resetting the data when changing the helicopter swash type:

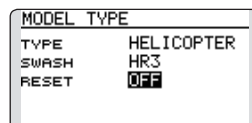

(Helicopter)

Move the cursor to [OFF] and push the RTN button to switch to the data input mode.

Select [ON] by scrolling the Push dial and push the RTN button. A confirmation message appears. Push the RTN button.

Activate the swash type setting. The swash setting parameters are reset.

*The wing types which can be selected depend on the mode; T-FHSS Air or S-FHSS.

Model type selection (Airplane, Glider)

•Wing type (Normal)

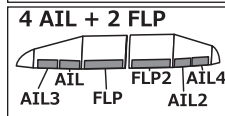
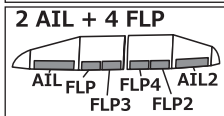
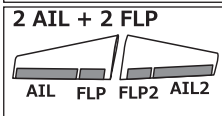
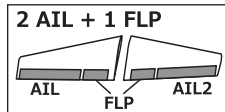
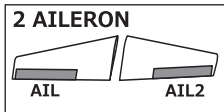
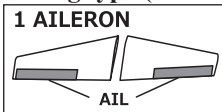

•Wing type (Tailless wing)

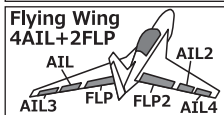
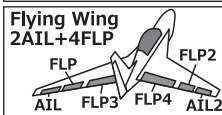
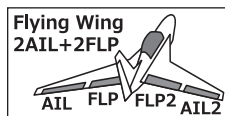
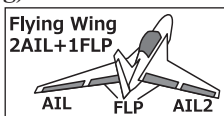
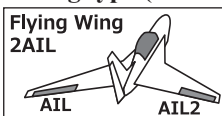

•Rudder type

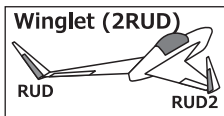
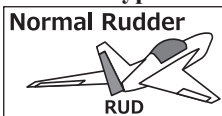

•Tail type

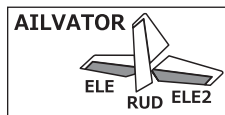
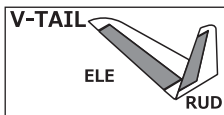
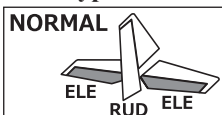

Model type selection (Helicopter)

•Swash type

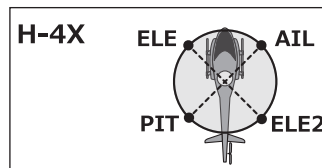
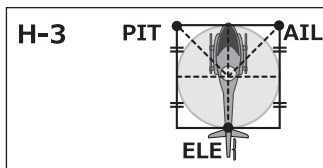
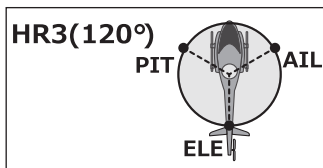
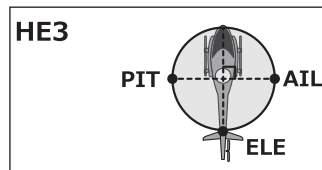
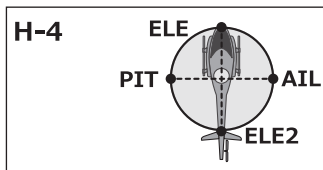
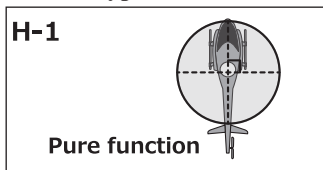

System Type selection

The T12K is for 2.4GHz only. The system can be changed from among 2 choices: T-FHSS Air (12CH+ON/OFF-2CH) and S-FHSS (8CH).

*If you change the System Type, other model data is not reset.

*If a system type is changed in helicopter mode, the transmitter will offer two selections:

[Yes] : Selection sets the channel order suitable for System Type. (We recommend here.)

[No] : The present channel order is maintained.

*After any change, remember to test the model and should fully check servo direction and a motion.

- Select [SYSTEM] in the Linkage menu and access the setup screen shown below by pushing the RTN button.

- Select the function name and return to the Linkage menu by pushing the RTN button or pushing the HOME/EXIT button.

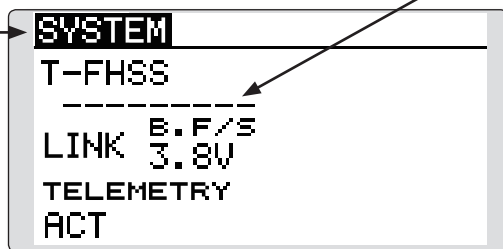

- In the case of T-FHSS, the ID of the linked receiver is displayed.

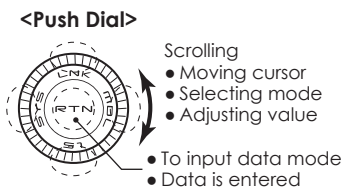

Battery fail-safe voltage setup (only T-FHSS Air)

The voltage which battery fail-safe activates, can be set when you link. (3.5-8.4V) The receiver memorizes the setting as it was at link.

Suggested setting voltages are as follows.

- 4 cells NiCd or NiMH (Normal: 4.8v) = 3.8 v
- 2 cells LiFe (Normal: 6.6 v) = 6.0 ~ 6.2 v
- 2 cells LiPo (Normal: 7.4 v) = 7.2 ~ 7.4 v

It is a rough reference value.

Since it changes with servos carried in the condition and the model of a battery, please set to your own model in a battery consumption current.

Cases when linking is necessary:

- When using a receiver other than the initial setting.
- When the communication system was changed. (T-FHSS Air ↔ S-FHSS)
- When a new model was created by model selection.

Linking method

Telemetry function (T-FHSS Air mode only)

To use the telemetry function, set “Telemetry” to “ACT”.

Receiver linking

The receiver will only be controlled (without being affected by other transmitters) by the transmitter it is linked to. When using a receiver other than one purchased as a set, linking is necessary.

Moreover, a re-link is required when a new model is added by model selection, and the time of system type change.

System Type selection procedure

1. Move the cursor to the [T-FHSS] item and push the RTN button to switch to the data input mode.

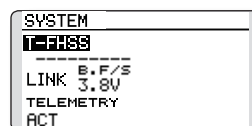

2. Select the system type by scrolling the Push dial. [T-FHSS] or [S-FHSS]
3. Push the RTN button to end adjustment and return to the cursor mode.

System	T-FHSS Air	S-FHSS
CH	12CH+ON/OFF 2CH	8CH
Telemetry	Possible	Impossible
Receiver (2017,11)	R3006SB R3008SB R3001SB	R2006GS R2106GF R2008SB R2001SB

*The surface system receivers receiver cannot be used.

FUNCTION

Channel assignment of each function can be changed.

When you select model and wing (swash) types, you will find that the optimized combinations of servo output channels and functions have been already preset. If you would like, you can freely change combinations of servo output channels, functions (aileron, elevator, etc), and control (sticks, switches, and trim levers).

*You can also assign the same function to multiple servo output channels such as assigning elevator function to CH2 and CH3.

Channel Replacement

When the channel is replaced in the Function menu, replaced channel uses the setting data (ATV, SUB-TRIM, REVERSE, F/S, and B-F/S, etc.).

Servo Output Channels

For T-FHSS Air mode, you can set 12 linear channels and two digital channels. For S-FHSS mode, you can set only 8 linear channels.

*DG1/2 (digital channels)

These channels can function as switched channels. You can freely change combinations between servo output channels and input controls (sticks, switches, and trim levers).

Motor Function

If you have either a Glider or Airplane Model Type selected and choose to activate the Motor function, a reverse setting screen is displayed.

*If YES is selected, the output is reversed. If NO is selected, the output is normal.

Warning

⚠ To prevent the motor from starting unexpectedly, switch off the motor. We also suggest removing the propeller from the motor as an additional precaution.

- Select [FUNCTION] in the Linkage menu and access the setup screen shown below by pushing the RTN button.

- Select the function name and return to the Linkage menu by pushing the RTN button or pushing the HOME/EXIT button.



FUNCTION	NORMAL	1/4
	CTRL	TRIM
1 AIL	J1	T1 SEPAR
2 ELE	J3	T3 SEPAR
3 THR	J2	T2 SEPAR
4 RUD	J4	T4 SEPAR

- Trim operation mode "COMB": Combination mode "SEPAR": Separate mode It sets up by **T1-T4 SET** of LINKAGE MENU.

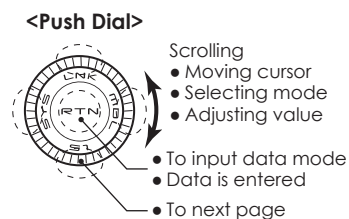

(The display screen is an example. The screen depends on the model type.)

Function change

1. Move the cursor to the function item of the channel you want to change and push the RTN button.

*The function selection screen is displayed.

2. Move the cursor to the function name you want to set and push the RTN button.

*The function name blinks.

3. Push the RTN button to execute the change. (When you want to cancel this operation, push the S1 button.)

*Multiple channels can be assigned to one function.

Operation control change

1. Move the cursor to the "CTRL" item of the channel you want to change and push the RTN button.

*The control selection screen is displayed.

H/W SELECT
J1 SA SE LD T1
J2 SB SF RD T2
J3 SC SG LS T3
J4 SD SH RS T4 --

2. Move the cursor to the control you want to change, and push the RTN button.

*The same control can be assigned to multiple channels.

Camber/Motor/Butterfly control setting (glider)

*Camber/motor/butterfly function control can be changed for each condition.

FUNCTION	NORMAL	3/4
9 CAMB	LS <input checked="" type="checkbox"/> --	
10 BFLY	J2 G --	
11 MOT	SG G --	
12 AUX1	-- --	

Camber, motor or butterfly control group/single setting is performed at the function setup screen.

"G": Group (common to all conditions)

"S": Single (set for each condition)

Trim setting

Move the cursor to the "TRIM" item of the channel you want to change and push the RTN button.

*The trim setup screen is displayed.

H/W SELECT		
J1 SA SE LD T1	RATE	+30%
J2 SB SF RD T2	MODE	NORMAL
J3 SC SG LS T3		
J4 SD SH RS T4	--	

The following items can be set at the trim setup screen:

Trim selection

Move the cursor to the trim, lever, etc. you want to set and push the RTN button.

*The setting can be changed.

Trim rate setting

Move the cursor to the [RATE] item and push the RTN button to switch to the data input mode.

Set the trim rate by scrolling the Push dial.

Initial value: +30%

Adjustment range : -150~+150%

(When the RTN button is pushed for one second, the trim rate is reset to the initial value.)

Push the RTN button to end adjustment and return to the cursor mode.

Trim mode selection

Move the cursor to the [MODE] item and push the RTN button to switch to the data input mode.

Select the trim mode by scrolling the Push dial. A confirmation message appears. Push

the RTN button to change the mode. (To terminate input and return to the original state, push the S1 button.)

[NORM]: Normal mode. Normal trim (parallel shift trim) operation.

[ATL]: ATL operation mode. Maximum change near idle or low-stick position, normally used with throttle trim. It is also possible to reverse the travel.

*[NORMAL]/[REVERSE] selection is possible in "ATL" mode.

Throttle trim (helicopter only)

*The throttle trim in conditions other than "normal" condition can be inhibited.

When other than normal condition is selected, move the cursor to throttle trim on the function setup screen and push the RTN button for 1 second.

FUNCTION	IDLEUP1	1/4
1 AIL	J1	T1 SEPAR
2 ELE	J3	T3 SEPAR
3 THR	J2	<input checked="" type="checkbox"/> SEPAR
4 RUD	J4	T4 SEPAR

*When "X" is displayed, THR trim is inhibited in conditions other than normal condition.

Channel replacement

Move the cursor to the channel # you want to replace and push the RTN button to switch to the data input mode.

Select the destination channel # by scrolling the Push dial. A confirmation message appears. Push the RTN button to replace the channel. (To terminate input and return to the original state, push the S1 button.)

SUB-TRIM

Setting of neutral position of each servo.

The Sub-Trim function is used to set the servo neutral position, and may be used to make fine adjustments to the control surface after linkages and pushrods are hooked up. When you begin to set up a model, be sure that the digital trims are set to their center position.

- Select [SUB-TRIM] in the Linkage menu and access the setup screen shown below by pushing the RTN button.

• Select the function name and return to the Linkage menu by pushing the RTN button or pushing the HOME/EXIT button.



SUB-TRIM		1/2	
1AIL	+0	5GEAR	+0
2ELE	+0	6AIL2	+0
3THR	+0	7VFP	+0
4RUD	+0	8AUX5	+0

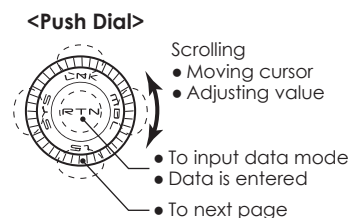

(The display screen is an example. The screen depends on the model type.)

Sub-trim adjustment

1. Move the cursor to the channel you want to adjust and push the RTN button to switch to the data input mode.
2. Adjust the rate by scrolling the Push dial.
Initial value: 0
Adjustment range: -240~+240 (steps)
(When the RTN button is pushed for one second, sub-trim is reset to the initial value.)
*Before sub-trim adjustment, it is very important to adjust the linkages at the control surface so that you do not use sub-trim, except for very minute adjustments.
3. Push the RTN button to end adjustment and return to the cursor mode.
4. Repeat this procedure for each channel.

REVERSE

Use to reverse the throw direction.

Servo Reverse changes the direction of an individual servo's response to a control input.

For CCPM helicopters, be sure to read the section on Swash AFR before reversing any servos. With CCPM helicopters, always complete your servo reversing prior to any other programming. If you use pre-built Airplane/Sailplane functions that control multiple servos, it may be confusing

to tell whether the servo needs to be reversed or a setting in the function needs to be reversed. See the instructions for each specialized function for further details. Always check servo direction prior to every flight as an additional precaution to confirm proper model memory, hook ups, and radio function.

- Select [REVERSE] in the Linkage menu and access the setup screen shown below by pushing the RTN button.

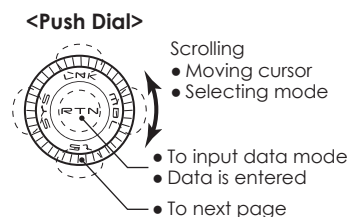
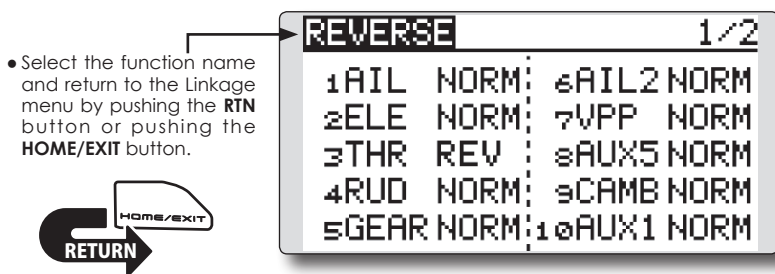

(The display screen is an example. The screen depends on the model type.)

Servo reversing procedure

*Upon setup completion of a new model, check whether or not each servo is connected to the correct channel.

*Next, determine whether you need to reverse any channels by moving each stick and/or other control inputs.

1. Move the cursor to the channel you want to reverse and push the RTN button to switch to the data input mode.
2. Select the direction by scrolling the Push dial. A confirmation message appears.

[NORM]: Normal

[REV]: Reverse

3. Push the RTN button to change the direction. (To terminate input and return to the original state, push the S1 button.)

*Repeat the operation above for each channel that must be reversed.

⚠ Danger

❗ Before a flight, always check that your model's servo operation, the direction of control surfaces, and switch setup are correct.

❗ Default setting of the throttle/motor channel is always reverse.

FAIL SAFE

Sets the servos operating position when transmitter signals can no longer be received or when the receiver battery voltage drops.

The Failsafe function may be used to set up positions that the servos move to in the case of radio interference.

You may set either of two positions for each channel: Hold, where the servo maintains its last commanded position, or failsafe, where each servo moves to a predetermined position. You may choose either mode for each channel.

The T12K system also provides you with an advanced battery monitoring function that warns you when the receiver battery has only a little power remaining. In this case, each servo is moved to the defined failsafe position. The battery failsafe may be released by operating a predefined control on the transmitter (default is throttle), do not continue to fly, land as soon as possible. Remember, if the predefined control suddenly moves to a position you did not command, land at

once and check your receiver battery.

Defines servo position when signals are lost and when receiver battery voltage becomes low.

⚠ Warning

❗ For safety, always set the fail safe functions.

- Remember to set the throttle channel fail safe function so that the servo moves to the maximum slow side for airplanes and to the slow side from the hovering position for helicopters. Crashing of the model at full high when normal radio waves cannot be received due to interference, etc., is very dangerous.
- If the battery fail safe is reset by the throttle stick, it may be mistaken for an engine malfunction and will be reset at throttle slow and the model will continue to fly. If you have any doubts, immediately land.

- Select [FAIL SAFE] in the Linkage menu and access the setup screen shown below by pushing the RTN button.

- Select the function name and return to the Linkage menu by pushing the RTN button or pushing the HOME/EXIT button.

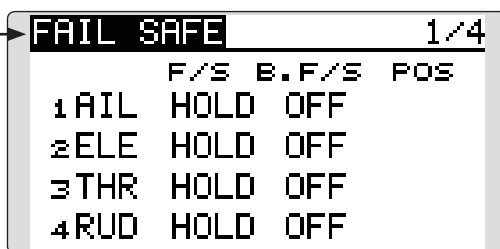

(The display screen is an example. The screen depends on the model type.)

<Push Dial>

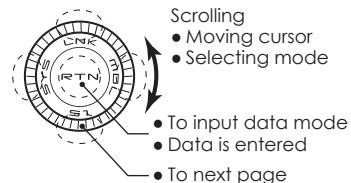

Fail safe setting procedure

1. Move the cursor to the "F/S" item of the channel you want to set and push the RTN button to switch to the data input mode.
2. Select the F/S mode by scrolling the Push dial. A confirmation message appears.
*The display blinks.
3. Push the RTN button. (Push the S1 button to stop setting.)
*The channel switches to the F/S mode.
4. Move the cursor to the "POS" item.
Hold the corresponding stick, knob, slider, etc. in the position you want the servo to move to when the fail safe function is activated and push the RTN button for one second.

*The set position is displayed in percentage.

*If you want to return that channel to the hold mode, move the cursor to the "F/S" item and push the RTN button to switch to the data input mode. Select the F/S mode by scrolling the Push dial. A confirmation message appears and then change the mode by pushing the RTN button.

Battery fail safe setting procedure

Battery fail safe can be set for each channel by the same method as the fail safe setting procedure. Select and set the "B.F/S" item.

[ON]: Battery fail safe function ON

[OFF]: Battery fail safe function OFF

Battery fail safe release switch setting

This function temporarily releases the battery fail safe function so the fuselage can recover after the battery fail safe function was activated by a drop in the receiver battery voltage. This setting selects the switch which releases the battery fail safe function.

1. Move the cursor to the [RELEASE B.F/S] item in the setup screen (last page).
2. Push the RTN button.

*The switch selection screen is called.

*For a detailed description of the switch selection and ON/OFF direction setting method, see [Switch Setting Method] at the back of this manual.

END POINT

Sets the travel and limit point of each servo.

The End Point function adjusts the left and right servo throws, generates differential throws, and will correct improper linkage settings.

The travel rate can be varied from 0% to 140% in each direction on channels 1 to 12 (T-FHSS Air). Also, the limit point where servo throw stops may be varied from 0% to 155%.

- Select [END POINT] in the Linkage menu and access the setup screen shown below by pushing the RTN button.

- Select the function name and return to the Linkage menu by pushing the RTN button or pushing the HOME/EXIT button.



END POINT		1/3	
	←←←	←←←	←←←
1 AIL	135 100	100 135	
2 ELE	135 100	100 135	
3 THR	135 100	100 135	
4 RUD	135 100	100 135	

(limit point) (travel) (travel) (limit point)

(The display screen is an example. The screen depends on the model type.)

<Push Dial>

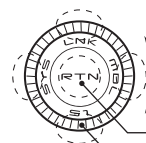

- Scrolling
- Moving cursor
 - Selecting mode
 - Adjusting value

- To input data mode
- Data is entered
- To next page

Servo travel adjustment

1. Move the cursor to the travel icon of the channel you want to adjust and push the RTN button to switch to the data input mode.

2. Adjust the rate by scrolling the Push dial.

Initial value: 100%

Adjustment range: 0%~140%

*When the RTN button is pushed for one second, the rate is reset to the initial value.

Push the RTN button to end adjustment and return to the cursor mode.

3. Repeat this procedure for each rate.

Limit point adjustment

1. Move the cursor to the limit point icon of the channel you want to adjust and push the RTN button to switch to the data input mode.

2. Adjust the limit point by scrolling the Push dial.

Initial value: 135%

Adjustment range: 0%~155%

*When the RTN button is pushed for one second, the limit point is reset to the initial value.

Push the RTN button to end adjustment and return to the cursor mode.

3. Repeat this procedure for each limit point.

SERVO SPEED

Sets the speed of each servo.

The speed of the servo from 1CH to 12CH operation can be set up.

It can adjust from 0 to 27.

The initial speed value is "0". Servo speed will slow as this value is increased to represent the highest servo speed.

* Speed cannot be faster than the maximum rate of the servo to be used.

* You cannot use this method to change servo speed at the same time you use the speed control of an S.BUS servo setup. This will cause some overlap. Please only use one method or the other.

* The speed of THR is not set up simultaneously with THR DELAY (model menu : only airplane).

- Select [SERVO SPEED] in the Linkage menu and access the setup screen shown below by pushing the RTN button.

- Select the function name and return to the Linkage menu by pushing the RTN button or pushing the HOME/EXIT button.

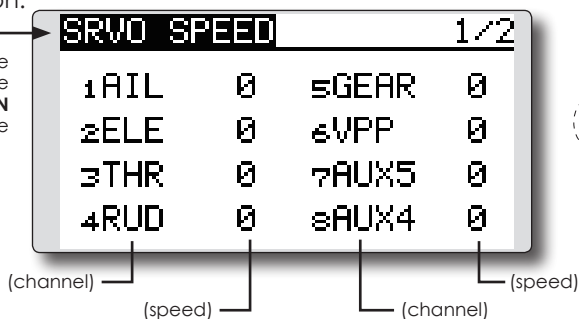

(The display screen is an example. The screen depends on the model type.)

<Push Dial>

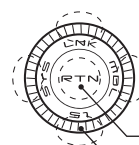

Scrolling

- Moving cursor
- Adjusting value

- To input data mode
- Data is entered
- To next page

Servo speed setting

1. Push the Speed button of the channel you want to set.

2. Use the adjustment buttons to adjust the servo speed.

• Initial value: 0

• Adjustment range: 0~27 (steps)

*When the RTN button is pushed for one second, the rate is reset to the initial value.

3. Repeat this procedure for each channel.

THR CUT

Stops the engine safely and easily (airplane and helicopter only)

Throttle cut provides an easy way to stop the engine. Generally speaking, modelers will do so by flipping a switch with the throttle stick at idle. The action is not functional at high throttle to avoid accidental dead stick landings. The switch's location and direction must be chosen, as it defaults to NULL.

Individually adjust the throttle cut activation setting for each condition. (helicopter)

- Select [THR CUT] in the Linkage menu and access the setup screen shown below by pushing the RTN button.

- Select the function name and return to the Linkage menu by pushing the RTN button or pushing the HOME/EXIT button.

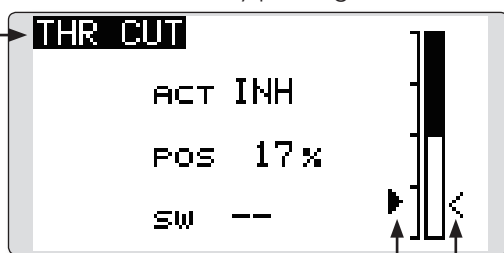

<Push Dial>

- Scrolling
- Moving cursor
- Selecting mode
- Adjusting value
- To input data mode
- Data is entered

- Current throttle position
- Cut position

Throttle cut setting procedure

1. Activate the function:

Move the cursor to the [ACT] item and push the RTN button to switch to the data input mode.

Select the ACT mode by scrolling the Push dial.

*The display blinks.

Push the RTN button to activate the function and return to the cursor mode.

2. Switch selection:

Move the cursor to the [SW] item and access the switch setup screen by pushing the RTN button and select the switch and ON direction.

*For a detailed description of the setting method, see [Switch Setting Method] at the back of this manual.

3. Throttle cut position setting:

Move the cursor to the [POS] item and push the RTN button to switch to the data input mode.

Adjust the servo operation position at throttle cut operation by scrolling the Push dial.

Initial value: 17%

Adjustment range: 0%~50%

*When the RTN button is pushed for one second, the servo operation position is reset to the initial value.)

Push the RTN button to end the adjustment and return to the cursor mode.

*Since conditions are not offered when an airplane is selected, the throttle cut options will vary from the options noted below.

*The throttle cut POS and SW settings are utilized for all conditions.

*If the throttle cut switch is activated, or on, this status will continue even if the condition is changed to an inhibited setting.

*If the condition is inhibited (INH) the throttle cut is off if the SW is in the off position and the throttle stick is low.

*With the selected cut switch ON and the throttle stick at idle; adjust the rate until the engine consistently cuts off.

However, be sure that the throttle linkage is not pulled too tight or unreasonable force is not applied to the servo.

- Individually adjust the Throttle Cut activation setting for each condition. (helicopter)

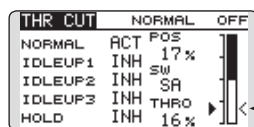

• Throttle cut status

Designating a throttle cut setting position. (helicopter)

*A throttle cut function acts in the low side of the throttle position.

*"THRO" setting is common with all condition.

⚠ Warning

❗ Normal setting is slightly above idle.

- To add the throttle cut position, use the cursor to select the THRO percentage desired. Then, push and hold the RTN button for one second.

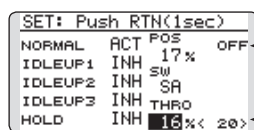

• Throttle cut status

• Throttle stick position

IDLE DOWN

Lowers the engine idling speed (airplane only)

The Idle Down function lowers the engine to its idle position. Like throttle cut, this is usually accomplished by flipping a switch with the throttle stick at idle. The action is not functional at high throttle to avoid accidental dead sticks. The switch's location and direction must be chosen, as it defaults to NULL.

- Select [IDLE DOWN] in the Linkage menu and access the setup screen shown below by pushing the RTN button.

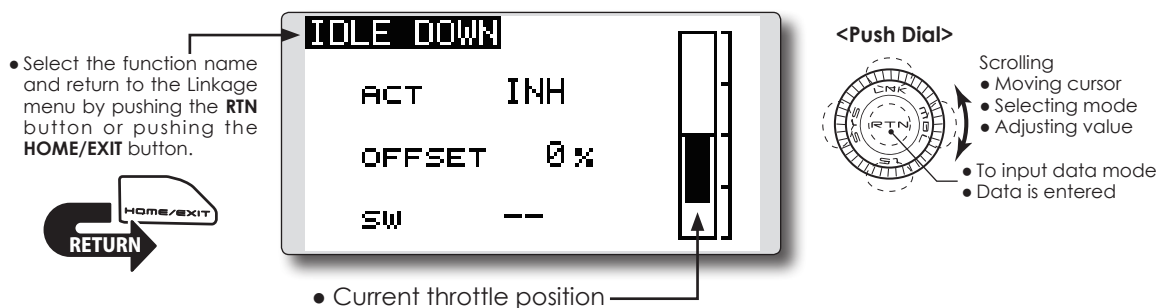

Idle down setting procedure

1. Activate the function:

Move the cursor to the [ACT] item and push the RTN button to switch to the data input mode.

Select the ACT mode by scrolling the Push dial.

*The display blinks.

Push the RTN button to activate the function and return to the cursor mode.

2. Switch selection:

Move the cursor to the [SW] item and access the switch setup screen by pushing the RTN button. Select the switch and ON direction.

*For a detailed description of the setting method, see [Switch Setting Method] at the back of this manual.

3. Offset rate setting:

Move the cursor to the [OFFSET] item and push the RTN button to switch to the data input mode.

Adjust the servo offset rate at idle down operation by scrolling the Push dial.

Initial value: 0%

Adjustment range: -100%~0%~+100%

*When a minus rate is input, an offset is applied at the high side.

*Maximum offset amount is near maximum slow.

*When the RTN button is pushed for one second, the offset rate is reset to the initial value.

Push the RTN button to end the adjustment and return to the cursor mode.

SWASH RING

Limits the swash plate travel to within a fixed range. (Helicopter only)

This function limits the swash travel to a fixed range in order to prevent damaging the swash linkage by simultaneous operation of the ailerons and elevators. It is very useful in 3D aerobatics which use a large travel.

- Select [SWASH RING] in the Linkage menu and access the setup screen shown below by pushing the RTN button.

- When the swash ring function is activated, a circle is displayed in the operating range display area and the rate input box is displayed. Stick operation is limited to the area of this circle.

• Select the function name and return to the Linkage menu by pushing the RTN button or pushing the HOME/EXIT button.

• The operating range display area: The vertical direction shows the elevator travel. The horizontal direction shows the aileron travel.

• The marker shows the stick position.

<Push Dial>

- Scrolling
- Moving cursor
- Selecting mode
- Adjusting value
- To input data mode
- Data is entered

Swash ring setting procedure

1. Activate the function:

Move the cursor to the [ACT] item and push the RTN button to switch to the data input mode.

Select the ACT mode by scrolling the Push dial.

*The display blinks.

Push the RTN button to activate the function and return to the cursor mode.

2. Rate setting:

Move the cursor to the [RATE] item. Push the RTN button to switch to the data input mode.

Set the rate by scrolling the Push dial.

Initial value: 100%.

Adjustment range: 50 to 200%.

*Adjust the rate to maximum swash tilt.

*When the RTN button is pushed for one second, the rate is reset to the initial value.

Push the RTN button to end adjustment and return to the cursor mode.

Neutral Point

At your linkages, if the servo horn deviates from a perpendicular position at neutral, the linkage compensation functions in this menu may not compensate effectively. To correct this use the Neutral Point function. This will move the neutral point of the servos to the actual perpendicular position. However, this adjustment changes only the axis point of the compensation functions in this menu, and does not affect the neutral position of other functions.

Swash AFR

Swash AFR function reduces, increases, or reverses the rate (travel) of the aileron, elevator and collective pitch functions, by adjusting or reversing the motion of all servos involved in that function, only when using that function.

Mixing Rate

This mixing is used to compensate the swashplate as necessary during specific control

inputs. The following compensation mixing is possible: PIT to AIL, PIT to ELE, AIL to PIT, ELE to AIL, and ELE to PIT (HR3 mode.) It adjusts the swashplate for proper operation of each control using the corresponding compensation mixing.

Linkage Compensation

This compensation mixing is used to correct the swashplate for pitch control at low pitch and high pitch.

Speed Compensation

This function is used to cancel the reaction that is generated by the difference in the movements of each servo when the swashplate moves.

Subtrim

Subtrim for aileron, elevator and pitch can be set during swash setting.

Pitch adjustment function

High, neutral and low pitch fixed outputs can be used while adjusting the pitch.

- Select [SWASH] in the Linkage menu and access the setup screen shown below by pushing the RTN button.

- Select the function name and return to the Linkage menu by pushing the RTN button or pushing the HOME/EXIT button.

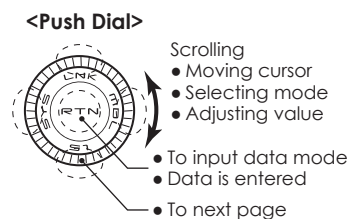
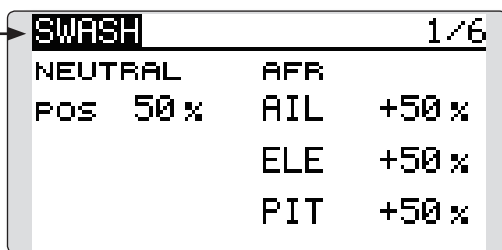

Neutral point setting procedure

The neutral point becomes the correction standard point.

*Adjusting the servo horn so that the neutral point is near the 50% position makes the mixing amount small.

1. Neutral point setting

Move the cursor to the [POS] item and hold the pitch operation so that the servo horn is at a right angle to the linkage rod. Push the RTN button for one second. This value indicates the servo's neutral position.

After reading the neutral point, use the other correction functions to make further adjustments.

Swash AFR setting procedure

The swash AFR function makes adjustments so that the servos travel the specified amount by [AIL], [ELE], and [PIT] operation.

1. Move the cursor to the function you want to adjust and push the RTN button to switch to the data input mode.
2. Adjust the AFR rate by scrolling the Push dial.
Initial value: +50%

Adjustment range: -100%~+100%

*When the RTN button is pushed for one second, the AFR rate is reset to the initial value.

Push the RTN button to end adjustment and return to the cursor mode.

Mixing rate setting procedure

The HR3 swashplate type will be used as an example to describe mixing rate setting. The mixing used in other swash modes may be different. However, the setting procedure is the same.

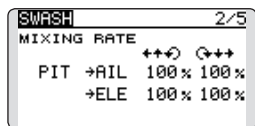

*Set the throttle stick to the preset neutral point. Adjust the length of the linkage rod so that the swash plate is horizontal at this position.

*The sub-trim function can be used to make small adjustments.

*Adjust so that the pitch curve is a straight line and the helicopter achieves maximum pitch.

*Move the cursor to the item you want to adjust and push the RTN button to switch to the data input mode. Push the RTN button to end adjustment and return to the cursor mode.

1. Adjusting the aileron operation [AIL to PIT]

Adjust the AIL to PIT rate so there is no binding in the elevator or pitch movement when the aileron stick is moved to the left and right.

*Adjust by scrolling the Push dial.

*The left and right sides can be adjusted individually.

2. Adjusting the elevator operation [ELE to AIL]/ [ELE to PIT]

Adjust the ELE to AIL and ELE to PIT rates so there is no binding in the aileron or pitch movement when the elevator stick is moved up and down.

*Adjust by scrolling the Push dial.

*The up and down sides can be adjusted individually.

3. Adjusting the pitch operation [PIT to AIL][PIT to ELE]

Adjust the PIT to AIL and PIT to ELE rates so that the swash plate moves to the level/horizontal position when the throttle stick was moved to maximum low and full high.

*Adjust by scrolling the Push dial.

*The low and high sides can be adjusted individually.

Linkage compensation setting procedure

*Prior to utilizing the linkage compensation settings, it is important to adjust the mixing rate settings.

*Linkage compensation overrides interference from the aileron operation with the elevator or elevator operation with the aileron at collective pitch control for low pitch and high pitch.

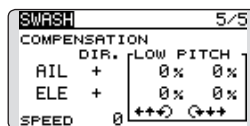

*When making the following setting, move the cursor to the item you want to set and push the RTN button to switch to the data input mode. Push the RTN button to end adjustment and return to the cursor mode.

1. Compensating aileron input [AIL]

Set the throttle to the lowest position. Move the aileron stick to the left and right and adjust the aileron compensation amount so that interference in the elevator or pitch direction is minimal.

*Adjust by scrolling the Push dial.

*The left and right sides can be adjusted individually.

*If the interference increases when the compensation amount was increased, make adjustments with the direction [DIR.] using the plus "+" or minus "-".

2. Compensating elevator input [ELE]

Adjust the elevator compensation amount so that the aileron or pitch direction interference when the elevator stick was moved up and down is minimal.

3. Repeat steps 1 and 2 above. Perform aileron and elevator compensation similarly at full throttle.

Speed compensation setting procedure

1. Move the cursor to the "SPEED" item and push the RTN button to switch to the data input mode.

2. Set the throttle stick to the neutral point position. Quickly move the elevator stick and adjust the speed compensation amount [SPEED] for minimum interference in the pitch direction.

*Adjust by scrolling the Push dial.

Push the RTN button to end adjustment and return to the cursor mode.

Subtrim setting procedure

Subtrim can be set on the last page of the swash setting screen.

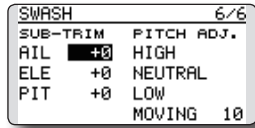

*The sub-trim value set here is reflected at sub-trim of the linkage menu.

Pitch adjustment procedure

The pitch adjustment function can be used on the last page of the swash setting screen.

1. Call the last page of the swash setting screen.
2. When the cursor is moved to a pitch adjustment button and the RTN button is pushed, the corresponding pitch is output.

* In the pitch adjustment mode an * is displayed at the left side of the current output setting button.

*If the cursor is moved to another button and the RTN button is pushed during pitch adjustment, the pitch adjustment mode is deactivated.

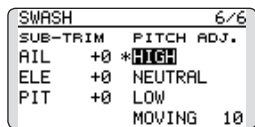
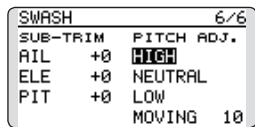

Function details are as follows:

Button	Function
High	High pitch fixed output mode
Neutral	Neutral pitch fixed output mode
Low	Low pitch fixed output mode
Moving	Cyclic pitch output mode

*The cyclic pitch speed can be set with the button at the right side of the "Moving" button.

Setting range: 1 to 100

*When the set value is large, motion becomes fast and when the set value is small, motion becomes slow.

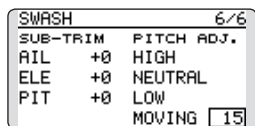

T1-T4 SET.

Digital trim settings

This function adjusts the digital trim's step amount and operation mode (T1~T4.)

When the flight conditions are set, the trim operation can be coupled with the conditions when combination mode is selected.

The T12K unit of trim is displayed on the home screen.

Only the trim displayed on the home screen can be moved to the center position without changing the actual trim's memory position.

- Select [T1-T4 SET.] in the Linkage menu and access the setup screen shown below by pushing the RTN button.
- Select the function name and return to the Linkage menu by pushing the RTN button or pushing the HOME/EXIT button.

STEP	MODE	UNIT
T1	4 SEPAR	--
T2	4 SEPAR	T1-T4 MEMORY
T3	4 SEPAR	INH
T4	4 SEPAR	

Trim operation mode
"COMB.": Combination mode
"SEPAR": Separate mode

<Push Dial>

- Scrolling
- Moving cursor
- Selecting mode
- Adjusting value
- To input data mode
- Data is entered

(The display screen is an example. The screen depends on the model type.)

Control step amount setting

1. Move the cursor to the [STEP] item and push the RTN button to switch to the data input mode.
2. Set the control step amount by scrolling the Push dial.
Initial value: 4
Adjustment range: 0~200
*When the RTN button is pushed for one second, the control step amount is reset to the initial value.
*When the value is increased, the change per step becomes larger.
3. Push the RTN button to end adjustment and return to the cursor mode.

Separate/combination mode selection (Heli and Glider only)

1. Move the cursor to the [MODE] item and push the RTN button to switch to the data input mode.
2. Select the mode by scrolling the Push dial. A confirmation message appears.
*The display blinks.
[COMB.]: Combination mode. The trim's data is reflected in all flight conditions.
[SEPAR]: Separate mode. Trim adjustments are made individually for each flight condition.
3. Push the RTN button. (To terminate the input and return to the original state, push the S1 button.)

Display unit selection

1. Move the cursor to the [UNIT] item and push the RTN button to switch to the data input mode.
2. Select the mode by scrolling the Push dial. A confirmation message appears.
*The display blinks.
[--]: A step number is displayed on the home screen. There is no unit display.
[%]: "%" is displayed as a unit.
3. Push the RTN button. (To terminate the input and return to the original state, push the S1 button.)

Trim Memory Operation procedure

1. Move the cursor to the [T1-T4 MEMORY] item and push the RTN button to switch to the data input mode.
2. Select the ACT mode by scrolling the Push dial. A confirmation message appears.
[INH]: Inhibited *The display blinks.
[ACT]: Activated
3. Push the RTN button. (To terminate the input and return to the original state, push the S1 button.)
4. At the home screen, move the cursor to the trim you want to change and push the RTN for one second. The trim display is moved to the center position.
*When the function is inhibited, the trim position returns to the actual trim position.

STK ALARM

Stick alarm

An alarm (single beep) can be sounded at the specified stick position.

- Alarm function ON/OFF can be set by switch.

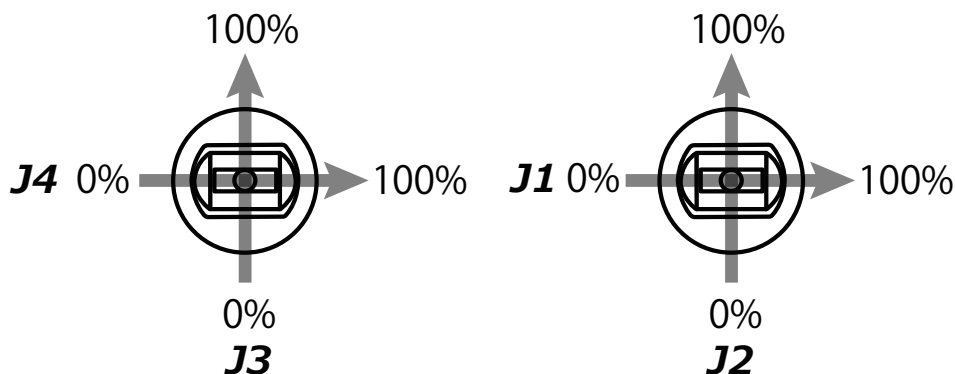

- Select [STK ALARM] in the Linkage menu and access the setup screen shown below by pushing the RTN button.

- Select the function name and return to the Linkage menu by pushing the RTN button or pushing the HOME/EXIT button.

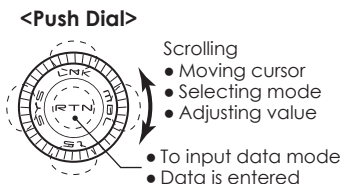
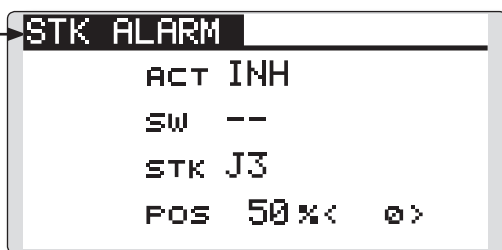

Stick alarm setting procedure

1. Activate the function:

Move the cursor to the [ACT] item and push the RTN button to switch to the data input mode.

Select the ACT mode by scrolling the Push dial.

*The display blinks.

Push the RTN button to activate the function and return to the cursor mode.

2. Switch selection:

Move the cursor to the [SW] item and access the switch setup screen by pushing the RTN button and select the switch and ON direction.

*For a detailed description of the setting method, see [Switch Setting Method] at the back of this manual.

3. Stick selection:

Move the cursor to the [STK] item and push the RTN button to switch to the data input mode.

Select the stick by scrolling the Push dial.

4. Alarm position setting:

Move the cursor to the [POS] item.

Adjust the position by select stick.

Push the RTN button.

WARNING

Low battery alarm voltage set warning normal reset

The T12K includes an audible alarm that sounds when the transmitter's battery voltage drops below a pre-determined setting; adjustable for cell types and voltages.

Mixing warning at power ON can be reset to OFF.

Warning display:

Airplane: Throttle cut/Idle down/Throttle position/Snap-roll/Motor position/Airbrake/Motor

Helicopter: Condition/Throttle cut/Throttle position/Throttle Hold

Glider: Condition/Motor position/Trim-mix/Motor

- Select [WARNING] in the Linkage menu and access the setup screen shown below by pushing the RTN button.

- Select the function name and return to the Linkage menu by pushing the RTN button or pushing the HOME/EXIT button.

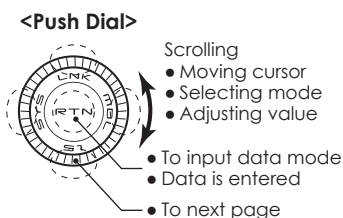
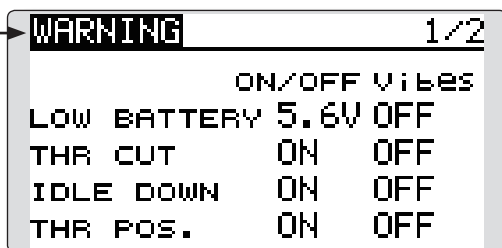

- Push S1 button to advance to next page.

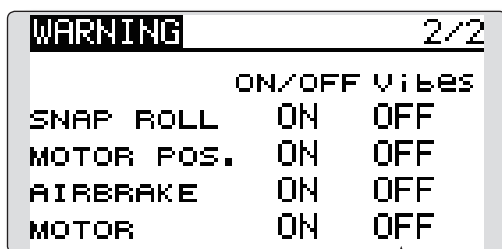

Accessing and Activating the Low Battery Alarm

1. The low battery (LOW BATTERY) alarm voltage is accessed through the T12K's System Menu. Within the System Menu, use the Push Dial to highlight the sound option and then push the return (RTN) button to confirm the selection.
2. Use the Push Dial to scroll to the low battery (LOW BATTERY) alarm, and then push the return (RTN) button to access the voltage settings. Using the Push Dial, adjust the voltage as desired and/or determined by the transmitter battery pack being utilized. The voltage options range from 4.2V to 7.4V. Suggested voltage settings are as follows:

- 5-Cell NiCd or NiMH: 5.6V
- 2-Cell LiFe: 6.0V

*Regarding low battery voltage: All models included in one 12K transmitter will be changed together. The voltage cannot be set to a separate value for each model, nor will data reset be carried out.

"Vibes" type

If the following types are selected, the transmitter will vibrate during the warning.

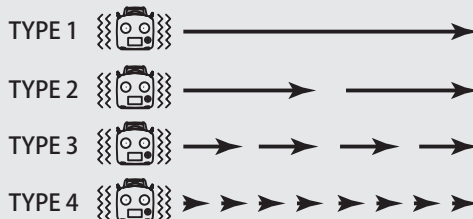

Warning normally resetting method

1. Move the cursor to the item you want to reset to OFF and push the RTN button to switch to the data input mode.
2. Select the OFF mode by scrolling the Push dial.
*The display blinks.
3. Push the RTN button. (To terminate the input and return to the original state, push the S1 button.)

TELEM.SET.

Telemetry setting

This screen does the following setting of telemetry. *It cannot be used in S-FHSS mode

- Telemetry speech
- Telemetry logging
- Telemetry alarm

- Select [TELEM.SET.] in the Linkage menu and access the setup screen shown below by pushing the RTN button.

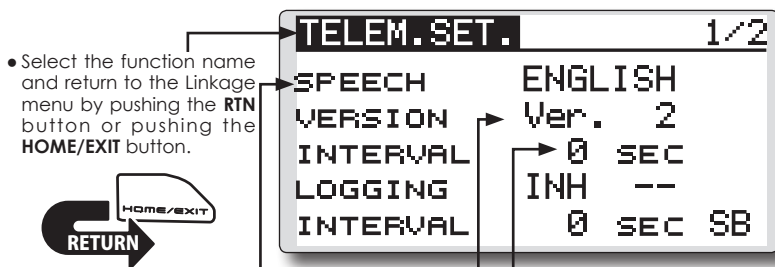

- Select the function name and return to the Linkage menu by pushing the RTN button or pushing the HOME/EXIT button.



The speech language installed is indicated. When the speech data is not installed, "-----" is displayed.

The version No. of the speech data file is indicated. When the speech data is not installed, nothing is displayed.

The interval of speech can be set. The setting range is from 0 [Sec] to 30 [Sec].

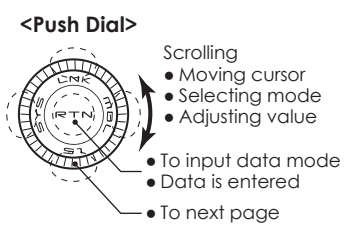

Telemetry Data Logging

You must have a micro SD card inserted to use data logging.

ACT/INH button, ON/OFF switch and INTERVAL button has been added to "TELEM.SET." screen.

When the LOGGING is set to ACT and ON, data will be logged based on the INTERVAL set.



When the logging function is ON, "ON" is displayed here. Logging ON/OFF switch.

ACT/INH

Logging ON/OFF switch

Logged data is written to the SD at the interval input here



This is a hardware for the pause switch of the telemetry logging function.

If the pause switch is turned on while the telemetry data is recorded, recording the telemetry data to the memory card is stopped temporarily. When the pause switch is turned off, logging the telemetry data is resumed and recorded to same data file after the interval time.

◆ **The T12K writes a tiny file system to the micro SD card. Please note the following information about Data Logging.**

* Approximately 0.3 sec is needed to write a new file to the micro SD card. This means the actual start of logging data is 0.3 Sec after the logging switch is turned on.

* A maximum of 6393 records can be saved per file. (Each record contains the elapsed time, CH data and the telemetry data.)

* If the maximum of 6393 records is reached during the logging process, the T12K will automatically create a new file and continue to log data. Remember, if the system takes approximately 0.3 sec to create the new file, there will be a lapse in the logged data during that period of time.

*The file names of the logged data on the micro SD card are fixed. The first file will be labeled "LOG1".

If the logging ON/OFF switch is cycled during the same flying session, the data will continue to be written to

LOG1. However, if the maximum number of records is reached (6393), the system will create a new file named "LOG2". If additional files are needed they will be named sequentially, "LOG3", LOG4 and so on.

The logged elapsed time will continue to count in each of the log files.

Log files may be merged after being imported into a spreadsheet or similar software.

* When the INTERVAL is 0sec, the actual interval time is set to approximately 0.1 Sec.

* **FFS Ver.3.0 (free download)** is necessary to export the logged data from the micro SD card.

The "Export" function of FFS Ver. 3.0. creates a .csv file from the LOGx data file. The delimiter of the exported files will be "comma" or "semi-colon" based on the default setting of the PC used to import the data.

Caution

* Please do NOT use MODEL SELECT function while the logging function is ON.

TELEMETRY DATA LOG (icon)

The card icon indicates that the telemetry data logging function works at HOME screen and TELEM. MONI screen.

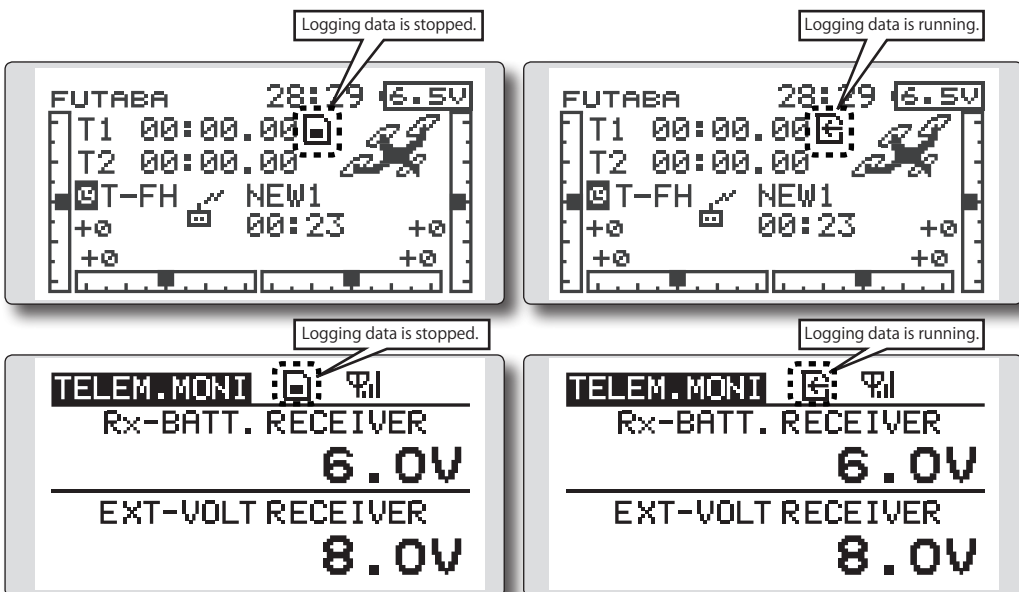

Telemetry Alarm Duration and Repeat Time

The repeat time and duration time for the telemetry alarm (buzzer, vibration and speech) can be set.

■ REPEAT

It is a repeat time of an alarm output.

Setting range : INH, 1s ~ 240s

■ DURATION

It is an alarm output time.

Setting range : 1s ~ 30s

*DURATION value has to be less than REPEAT value.

*DURATION time is extended when the other alarm event occurs.

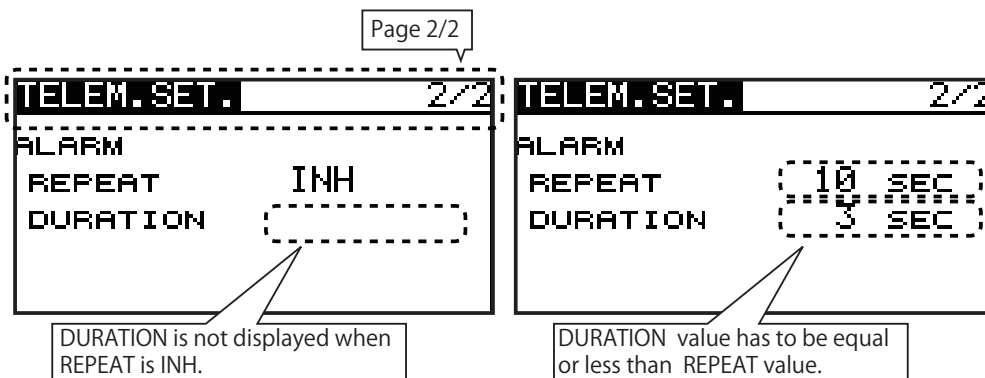

[Duration and Repeat Time for Telemetry Alarm]

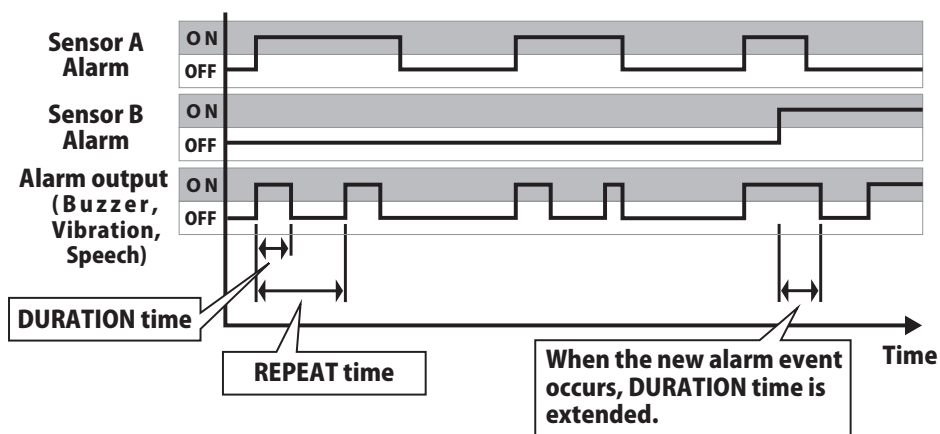

TELEMETRY

Displaying data from the receiver

This screen displays your choice of data from the receiver.

*It cannot be used in S-FHSS mode

Also warnings can be activated regarding other data from your aircraft. For example, if the receiver voltage drops, the user can be warned by an alarm (and vibration).

- [TELEMETRY] can be called if the HOME/EXIT button is pushed from a home screen.
- Select [TELEMETRY] in the Linkage menu and access the setup screen shown below by pushing the RTN button.

- Select the function name and return to the Linkage menu by pushing the RTN button or pushing the HOME/EXIT button.

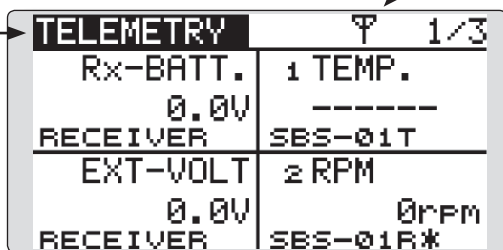

<Push Dial>

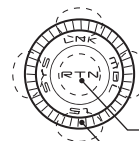

- Scrolling
- Moving cursor
- Selecting mode

- To input data mode
- Data is entered
- To next page

- Push S1 button to advance to next page.

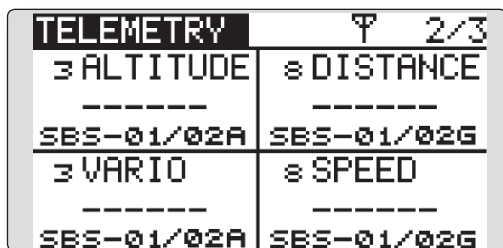

How to see telemetry data

1. Telemetry screen can be called if the HOME/EXIT button is pushed from the home screen. Or select [TELEMETRY] in the Linkage menu and access the setup screen by pushing the RTN button.
2. If each item is chosen and the RTN button is pushed, an alarm setup can be performed with the minimum/maximum after a transmitter is turned on.

*Receiver voltage can be checked immediately. An optional sensor will need to be attached to S.BUS2 of a receiver if you would like to see other information.

*No special setup is necessary if each sensor displayed is left as in the default setup. Separate sensor ID is also unnecessary. However, if two or more of one kind of sensor is used, setup is required in the "SENSOR" menu.

Warning

- ⚠ Do not watch the transmitter screen during flight.

*You may lose sight of the aircraft during flight and this is extremely dangerous. Have an assistant on hand to check the screen for you. A pilot should NEVER take his eyes off his aircraft.

Telemetry Speech function

*There are two languages available in the Speech data, English and German.

*The language chosen for the Speech data will affect only the Speech function. It will not change the language used in the transmitter's text display.

*The Speech function can only be used with headphones plugged into the phone jack.

*You will need to purchase headphones or earphones with a 3.5plug.

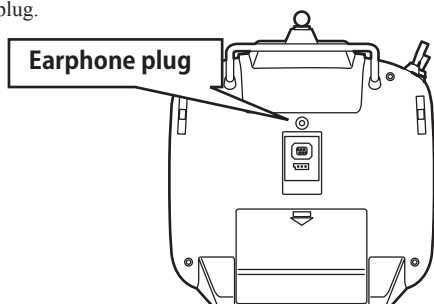

- ACT/INH button and ON/OFF switch button of the speech function are added to the telemetry alert screen.

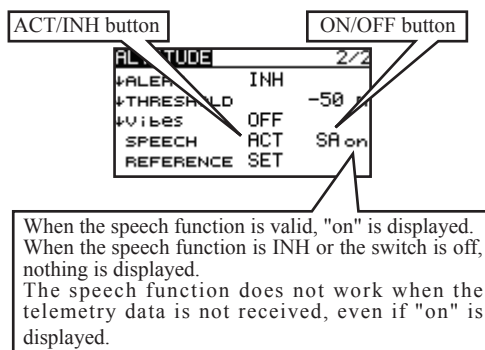

- When the telemetry alert occurred, the speech function works.

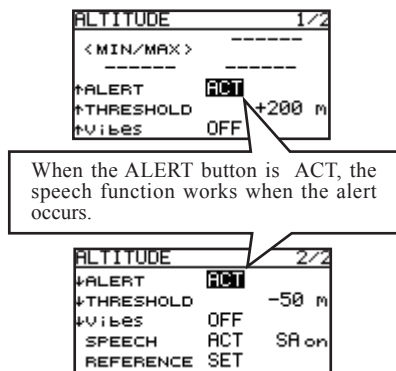

*The format of the speech output is

"warning" [sensor type] [data] [unit]

Ex. Rx battery

「warning」 「battery」 「four point zero」 「volt」

*If the telemetry data is changed frequently, the speech data will not be the same as the displayed data.

*The format of the speech output is

[sensor type] [data] [unit] [data] [data] [data] [data]

Ex. Rx battery

「battery」 「seven point four」 「volt」 「seven point four」 「seven point four」 「seven point four」 「seven point four」

*If the telemetry data is changed frequently, the speech data will not be the same as the displayed data.

TELEM.MONI (The extension of the number of telemetry data which is shown)

The number of telemetry data which is displayed to TELEM.MONI screen is extended. It is 16 items (4 pages) maximum.

The page number is memorized automatically.

Then, TELEM.MONI screen shows the page which was shown previously.

*The page is memorized even if the power is turned off.

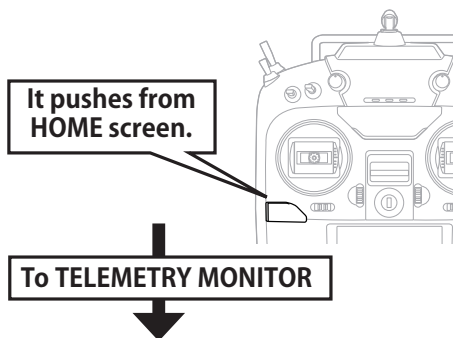

In T-FHSS Air 14CH mode, you can display any items on the telemetry screen up to 16 total. The benefit of expansion of a character will be obtained by choosing the display items 1 and 2.

Ex. 1 item is displayed

TELEM.MONI	Y
Rx-BATT. RECEIVER	
0.0	V

Ex. 2 items are displayed

TELEM.MONI	Y
Rx-BATT. RECEIVER	
0.0V	
EXT-VOLT RECEIVER	
0.0V	

Ex. 4-16 items are displayed

TELEM.MONI	Y	1/4
Rx-BATT. RECEIVER	ε BATTERY	
6.0V	6.0V	
EXT-VOLT RECEIVER	ε EXT-VOLT	
11.0V	11.1V	
	SBS-01V	

TELEM.MONI	Y	2/4
1 TEMP.	ε EXT-VOLT	
+32°C	11.1V	
SBS-01T	SBS-01V	
17 TEMP.	ε RPM	
+24°C	0rpm	
SBS-01T	SBS-01R*	

TELEM.MONI	Y	3/4
ε DISTANCE	ε ALTITUDE	
-----	-----	
SBS-01/02G	SBS-01/02G	
ε SPEED	ε VARIO	
-----	-----	
SBS-01/02G	SBS-01/02G	

TELEM.MONI	Y	4/4
ε ALTITUDE		

SBS-01/02A		
ε VARIO		

SBS-01/02A		

TELEMETRY MONITOR set up

- ① The **HOME/EXIT** button is pushed from HOME screen and **TELEMETRY MONITOR** is called.
- ② Move the cursor to the "RECEIVER" or "SENSOR" (SBS-XXX etc.) and push the RTN button.

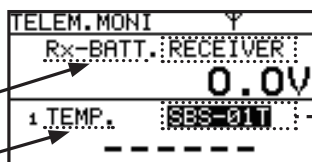

If a cursor is moved to items (**Rx-BATT, EXT-VOL, TEMP.** etc.) and RTN is pushed, the alarm setting screen of the item will be displayed.

- ③ You will use the "Display" function to choose how many sensors are shown on your Telemetry monitor.

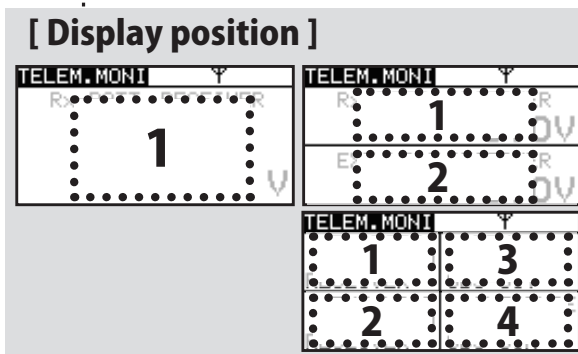
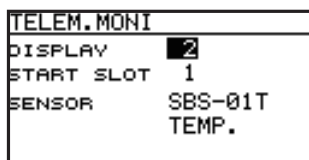

- ④ If you want to show two sensors on your Telemetry screen, select 2 in "Display". Then move down to the Sensor to select which other item is shown.

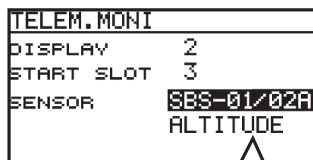

When using a sensor that has two or more functions, you will want to scroll to select which will be displayed. (**ALTITUDE,VARIO,** etc.)

- ⑤ If you want to show three sensors on your Telemetry screen, select 3 in "Display". Then move down to the Sensor to select which other item is shown.
- ⑥ To SENSOR "-----" selection will reduce a display item.

TELEMETRY : Rx-BATT.

Displaying data from the receiver battery voltage

In this screen, the battery voltage of a receiver is displayed.

*It cannot be used in S-FHSS mode

If it becomes higher or lower than the setting an alarm and/or vibration will alert you.

- Select [Rx-BATT.] in the TELEMETRY screen and access the setup screen shown below by pushing the RTN button.
- Select the function name and return to the Linkage menu by pushing the RTN button or pushing the HOME/EXIT button.
- The maximum and the minimum when powering ON are shown.
- Receiver battery voltage
- The "down" arrow will indicate that an alarm will sound when the voltage drops to below the setting.

Alert set

1. Move the cursor to the ↓ALERT [INH] item and push the RTN button to switch to the data input mode.
 2. Select the ACT mode by scrolling the Push dial.
 3. Push the RTN button. (To terminate the input and return to the original state, push the S1 button.)
 4. Move the cursor to the ↓THRESHOLD [4.0V] item and push the RTN button to switch to the data input mode.
 5. Adjust the rate by scrolling the Push dial.
Initial value: 4.0V
Adjustment range: 0.0V~8.4V
- *When the RTN button is pushed for one second, the rate is reset to the initial value.
6. Push the RTN button. (To terminate the input and return to the original state, push the S1 button.)

"Vibes" type

If the following types are selected, the transmitter will vibrate during the warning.

TYPE 1		—————→
TYPE 2		————→ ———→
TYPE 3		————→ ———→ ———→ ———→
TYPE 4		————→ ———→ ———→ ———→ ———→ ———→

TELEMETRY : EXT-VOLT

Displaying data from the EXT battery voltage port

***CA-RVIN-700 or SBS-01V must be installed in the aircraft.**

The EXT-VOLT screen will display the data from the EXT-battery output from the R3008SB receiver. In order to use this function, it is necessary to connect external voltage connector of the R3008SB receiver to a CA-RVIN-700 (FUTM5551) or SBS-01V to the battery you desire to measure the voltage of.

You will be alerted by an alarm or vibration if the voltage set by you is exceeded.

*It cannot be used in S-FHSS mode

- Select [EXT-VOLT] in the TELEMETRY screen and access the setup screen shown below by pushing the RTN button.

- Select the function name and return to the Linkage menu by pushing the RTN button or pushing the HOME/EXIT button.

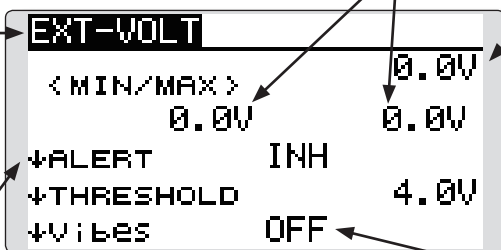

- The maximum and the minimum when powering ON are shown.

- EXT battery voltage

<Push Dial>

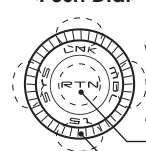

- Scrolling
- Moving cursor
 - Selecting mode
 - Adjusting value

- To input data mode
- Data is entered
- To next page

- ↓The arrow will indicate that an alarm will sound when the voltage drops to below the setting.

Alert set

1. Move the cursor to the ↓ALERT [INH] item and push the RTN button to switch to the data input mode.
2. Select the ACT mode by scrolling the Push dial.
3. Push the RTN button. (To terminate the input and return to the original state, push the S1 button.)
4. Move the cursor to the ↓THRESHOLD [4.0V] item and push the RTN button to switch to the data input mode.
5. Adjust the rate by scrolling the Push dial.
Initial value: 4.0V
Adjustment range: 0.0V~100.0V

*When the RTN button is pushed for one second, the rate is reset to the initial value.

6. Push the RTN button. (To terminate the input and return to the original state, push the S1 button.)

"Vibes" type

If the following types are selected, the transmitter will vibrate during the warning.

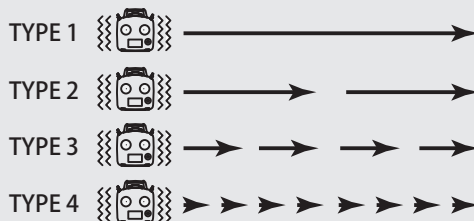

TELEMETRY : TEMP.

Displaying data from the temperature

***A temperature sensor must be installed in the aircraft.**

TEMP is a screen which displays/sets up the temperature information from an optional temperature sensor.

The temperature of the model (engine, motor, battery etc.) which is flying can be displayed.

If it becomes higher or lower than the setting an alarm and/or vibration will alert you.

*It cannot be used in S-FHSS mode

- Select [TEMP.] in the TELEMETRY screen and access the setup screen shown below by pushing the RTN button.
- Select the function name and return to the Linkage menu by pushing the RTN button or pushing the HOME/EXIT button.
- The maximum and the minimum when powering ON are shown.
- Temperature

<Push Dial>

- Scrolling
- Moving cursor
- Selecting mode
- Adjusting value
- To input data mode
- Data is entered
- To next page

- Push the S1 button to advance to the next page.
- An upward arrow will show that an alarm will sound when the temperature rises above the set value.
- A downward arrow will show that an alarm will sound when the temperature drops below the set value.

Alert set : Hot warning

1. Move the cursor to the ↑ALERT item and push the RTN button to switch to the data input mode.
 2. Select the ACT mode by scrolling the Push dial.
 3. Push the RTN button. (To terminate the input and return to the original state, push the S1 button.)
 4. Move the cursor to the ↑THRESHOLD [+100°C] item and push the RTN button to switch to the data input mode.
 5. Adjust the rate by scrolling the Push dial.
Initial value: +100°C
Adjustment range: -19°C ~200°C
(↑THRESHOLD > ↓THRESHOLD)
- *When the RTN button is pushed for one second, the rate is reset to the initial value.
6. Push the RTN button. (To terminate the input and return to the original state, push the S1 button.)

Alert set : Low-temperature warning

1. 2/2 page is accessed by pushing S1. Move the cursor to the ↓ALERT item and push the RTN button to switch to the data input mode.
 2. Select the ACT mode by scrolling the Push dial.
 3. Push the RTN button. (To terminate the input and return to the original state, push the S1 button.)
 4. Move the cursor to the ↓THRESHOLD [+0 °C] item and push the RTN button to switch to the data input mode.
 5. Adjust the rate by scrolling the Push dial.
Initial value: +0°C
Adjustment range: -20°C ~199°C
(↑THRESHOLD > ↓THRESHOLD)
- *When the RTN button is pushed for one second, the rate is reset to the initial value.
6. Push the RTN button. (To terminate the input and return to the original state, push the S1 button.)

"Vibes" type

If the following types are selected, the transmitter will vibrate during the warning.

TYPE 1		→
TYPE 2		→ →
TYPE 3		→ → → →
TYPE 4		→ → → → → →

TELEMETRY : RPM

Displaying data from the RPM

***A RPM sensor must be installed in the aircraft.**

RPM is a screen which displays / sets up the RPM information from an optional RPM sensor.

*It cannot be used in S-FHSS mode.

The RPM of the model (engine, motor, etc.) which is flying can be shown.

If it becomes higher or lower than the setting an alarm and/or vibration will alert you.

- Select [RPM] in the TELEMETRY screen and access the setup screen shown below by pushing the RTN button.
- The maximum and the minimum when powering ON are shown.
- Select the function name and return to the Linkage menu by pushing the RTN button or pushing the HOME/EXIT button.
- Select the sensor you use.
SBS-01RM : MAGNETIC
SBS-01RO : OPTICAL
SBS-01RB : BLS MOTOR
- In "MAGNETIC", the gear ratio of your engine (motor) you are using is entered.
- In "BLS MOTOR", the number of poles your brushless motor you are using is entered.
- Push the S1 button to advance to the next page.
- In "OPTICAL", the number of blades of the propeller (rotor) your model is entered.

"Vibes" type
If the following types are selected, the transmitter will vibrate during the warning.

TYPE 1		→
TYPE 2		→ →
TYPE 3		→ → → →
TYPE 4		→ → → → → →

Alert set : Over rotations

1. Move the cursor to the ↑ALERT item and push the RTN button to switch to the data input mode.
 2. Select the ACT mode by scrolling the Push dial.
 3. Push the RTN button. (To terminate the input and return to the original state, push the S1 button.)
 4. Move the cursor to the ↑THRESHOLD [2000 rpm] item and push the RTN button to switch to the data input mode.
 5. Adjust the rate by scrolling the Push dial.
Initial value: 2000rpm
Adjustment range: 1rpm~150,000rpm
(↑THRESHOLD > ↓THRESHOLD)
- *When the RTN button is pushed for one second, the rate is reset to the initial value.
6. Push the RTN button. (To terminate the input and return to the original state, push the S1 button.)

Alert set : Under rotations

1. Scroll to the second page by pushing S1. Move the cursor to the ↓ALERT item and push the RTN button to switch to the data input mode.
 2. Select the ACT mode by scrolling the Push dial.
 3. Push the RTN button. (To terminate the input and return to the original state, push the S1 button.)
 4. Move the cursor to the ↓THRESHOLD [0rpm] item and push the RTN button to switch to the data input mode.
 5. Adjust the rate by scrolling the Push dial.
Initial value: 0rpm
Adjustment range: 0rpm~149,999rpm
(↑THRESHOLD > ↓THRESHOLD)
- *When the RTN button is pushed for one second, the rate is reset to the initial value.
6. Push the RTN button. (To terminate the input and return to the original state, push the S1 button.)

TELEMETRY : ALTITUDE

Displaying data from the altitude

***An altitude sensor or GPS sensor must be installed in the aircraft.**

ALTITUDE is a screen which displays / sets up the altitude information from an optional altitude sensor or GPS sensor. The altitude of the model which is flying can be known. You can set an alarm to sound when the model flies above your preset maximum altitude. You can also choose to receive your warning as a vibration. The initial altitude data that appears when your power supply is turned on will be zero meters. From there, it displays your altitude as it changes. Even if the altitude

of an airfield is high, that shall be 0 m and the altitude difference from an airfield is displayed. This sensor calculates the altitude from atmospheric pressure. Atmospheric pressure will get lower as you go up in altitude. Using this the sensor will estimate the altitude. Please understand that an exact advanced display cannot be performed if atmospheric pressure changes in a weather situation.

*It cannot be used in S-FHSS mode

- Select [ALTITUDE] in the TELEMETRY screen and access the setup screen shown below by pushing the RTN button.
- Select the function name and return to the Linkage menu by pushing the RTN button or pushing the HOME/EXIT button.
- The maximum and the minimum when powering ON are shown.
- Altitude <Push Dial>
- Scrolling
 - Moving cursor
 - Selecting mode
 - Adjusting value
- To input data mode
- Data is entered
- To next page

- ↑ An upward arrow indicates the alarm will sound when the altitude reaches above your set value.
- ↓ A downward arrow indicates the alarm will sound when the altitude reaches below your set value.
- Push the S1 button to advance to the next page.

"Vibes" type

If the following types are selected, the transmitter will vibrate during the warning.

TYPE 1 →

TYPE 2 → →

TYPE 3 → → →

TYPE 4 → → → → →

First, you need to set a reference point.

1. The model and transmitter to which the altitude sensor was connected are turned on.
2. Move the cursor to the [SET] of "REFERENCE" item and push the RTN button to switch to the data input mode.
3. Push the RTN button. (To terminate the input and return to the original state, push the S1 button.)

*Atmospheric pressure is changed according to the weather also at the same airfield. You should preset before a flight.

Alert set : High side

1. Move the cursor to the ↑ALERT item and push the RTN button to switch to the data input mode.
2. Select the ACT mode by scrolling the Push dial.
3. Push the RTN button. (To terminate the input and return to the original state, push the S1 button.)
4. Move the cursor to the ↑THRESHOLD [+200m] item and push the RTN button to switch to the data input mode.
5. Adjust the rate by scrolling the Push dial.
Initial value: +200m
Adjustment range: -499m~+5,000m
(↑THRESHOLD > ↓THRESHOLD)

*When the RTN button is pushed for one second, the rate is reset to the initial value.

6. Push the RTN button. (To terminate the input and return to the original state, push the S1 button.)

Alert set : Low side

1. Scroll to the second page by pushing S1. Move the cursor to the ↓ALERT item and push the RTN button to switch to the data input mode.
2. Select the ACT mode by scrolling the Push dial.
3. Push the RTN button. (To terminate the input and return to the original state, push the S1 button.)
4. Move the cursor to the ↓THRESHOLD [-50m] item and push the RTN button to switch to the data input mode.
5. Adjust the rate by scrolling the Push dial.
Initial value: -50m
Adjustment range: -500m~+4,999m
(↑THRESHOLD > ↓THRESHOLD)

*When the RTN button is pushed for one second, the rate is reset to the initial value.

6. Push the RTN button. (To terminate the input and return to the original state, push the S1 button.)

TELEMETRY : VARIO

***An altitude sensor or GPS sensor must be installed in the aircraft.**

VARIO is a screen which displays / sets up the variometer information from an optional altitude sensor or GPS sensor.

The variometer of the model which is flying can be known.

If it becomes higher or lower than the setting an alarm and / or vibration will alert you.

To ensure that the pilot is aware as to the model's

Displaying data from the variometer

status, the T12K incorporates a different melody for ascent and descent. Additionally, depending upon the rate of climb or descent, the tones vary to indicate whether or not the airplane is climbing or descending at a rapid rate.

*It cannot be used in S-FHSS mode

- Select [VARIO] in the TELEMETRY screen and access the setup screen shown below by pushing the RTN button.
- Select the function name and return to the Linkage menu by pushing the RTN button or pushing the HOME/EXIT button.
- The maximum and the minimum when powering ON are shown.
- Variometer <Push Dial>
- Scrolling
 - Moving cursor
 - Selecting mode
 - Adjusting value
- To input data mode
- Data is entered
- To next page

↑ An upward arrow indicates the alarm will sound when the vario reaches above your set value.

↓ A downward arrow indicates the alarm will sound when the vario reaches below your set value.

• Push the S1 button to advance to the next page.

"Vibes" type

If the following types are selected, the transmitter will vibrate during the warning.

TYPE 1		→
TYPE 2		→ →
TYPE 3		→ → →
TYPE 4		→ → → → →

• If this is set to ACT, a melody will be activated during the rise or dive, depending on your set values.

Alert set : Rise side

1. Move the cursor to the ↑ALERT item and push the RTN button to switch to the data input mode.
2. Select the ACT mode by scrolling the Push dial.
3. Push the RTN button. (To terminate the input and return to the original state, push the S1 button.)
4. Move the cursor to the ↑THRESHOLD [+0m/s] item and push the RTN button to switch to the data input mode.
5. Adjust the rate by scrolling the Push dial.
Initial value: +0m/s
Adjustment range: -49m/s~+50m/s
(↑THRESHOLD > ↓THRESHOLD)
- *When the RTN button is pushed for one second, the rate is reset to the initial value.
6. Push the RTN button. (To terminate the input and return to the original state, push the S1 button.)

Alert set : Dive side

1. Scroll to the second page by pushing S1. Move the cursor to the ↓ALERT item and push the RTN button to switch to the data input mode.
2. Select the ACT mode by scrolling the Push dial.
3. Push the RTN button. (To terminate the input and return to the original state, push the S1 button.)
4. Move the cursor to the ↓THRESHOLD [+0m/s] item and push the RTN button to switch to the data input mode.
5. Adjust the rate by scrolling the Push dial.
Initial value: +0m/s
Adjustment range: -50m/s~+49m/s
(↑THRESHOLD > ↓THRESHOLD)
- *When the RTN button is pushed for one second, the rate is reset to the initial value.
6. Push the RTN button. (To terminate the input and return to the original state, push the S1 button.)

The vario melody outputs from the phone jack.

- *The melody function plays a different electronic melody when rising and diving.
- *To take advantage of this feature, a Futaba Telemetry Sensor (such as SBS-01A/02A, SBS-01G/02G, VARIO-F1712, VARIO-F1672 or GPS-F1672, sold separately) must be installed.

When the melody function is active, the vario melody outputs from the phone jack.

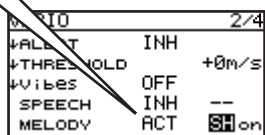

The priority of the phone output is below:
 Speaking Alarm >> Speaking data >> Vario Melody
 (High priority) (Low priority)

The melody function can be turned on and off with the specified switch.

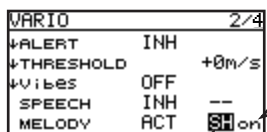

When the melody function is active, "on" is displayed.

Melody function switch display. When the cursor is moved to this option and the RTN button is pushed, the display changes to the switch selection screen.

Vario Melody Volume

The Vario Melody Volume to adjust by the hardware. (stick, trim, lever, switch)

This is the volume of Vario Melody only.

Setting range : 0 (silent) ~ 30 (maximum)

The hardware for the adjustment is selectable.

Setting range : J1, J2, J3, J4, T1, T2, T3, T4, SA, SB, SC, SD, SE, SF, SG, SH, LS, LD, RD, RS

The operation mode of the adjustment hardware is selectable.

ATL+ : When the operation direction is right or down or C.W. , the volume is increased.

ATL- : When the operation direction is right or down or C.W. , the volume is decreased.

SYM. : The center position is minimum volume. The Both end points are maximum volume.

- Select [SOUND] in the System menu and access the setup screen shown below by pushing the RTN button.

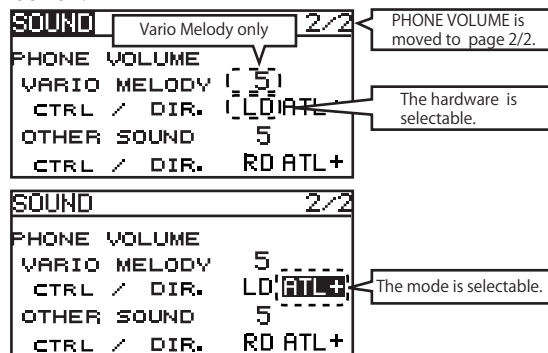

Vario Melody Setting

RANGE

This is the variable range of the Vario Melody.

↑ (Climb side) : When the variometer is greater than this value, Vario melody is not variable.

Setting range : OFFSET value ~ +50m/s(SBS-01/02A,SBS-01/02G)
 OFFSET value ~ +50.0m/s (GPS-F1675, VARIO-F1712)
 OFFSET value ~ +300.00m/s (VARIO-F1672)

↓ (Sink side) : When the variometer is less than this value, Vario melody is not variable.

Setting range : -50m/s ~ OFFSET value(SBS-01/02A,SBS-01/02G)
 -50.0m/s ~ OFFSET value (GPS-F1675, VARIO-F1712)
 -300.00m/s ~ OFFSET value (VARIO-F1672)

OFFSET

This is the changing point of climb and sink. When the variometer is greater than this value, Vario Melody is climb type. When the variometer is less than this value, Vario Melody is sink type.

Setting range : RANGE↑setting value ~ RANGE↓ setting value

DEADBAND

Vario Melody is not output in this range.

↑ (Climb side) : When the variometer is less than this value, Vario melody is not output.

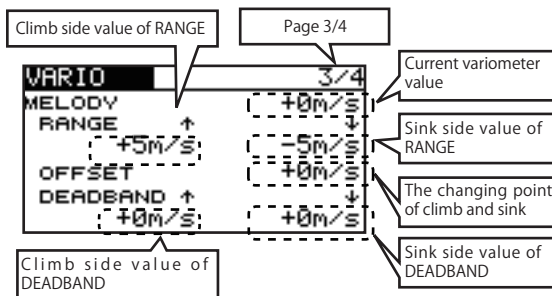

[The relation of Vario Melody settings]

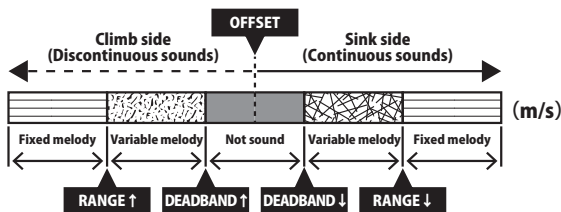

■ DELAY

The output vario melody does not change during the delay time. In other words, this is a minimum time of Vario melody output.

Setting range : 0.0, 0.5, 1.0, 1.5 sec

*This parameter is effective to all variometers.

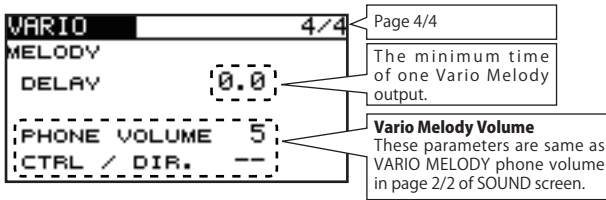

[Vario Melody Delay]

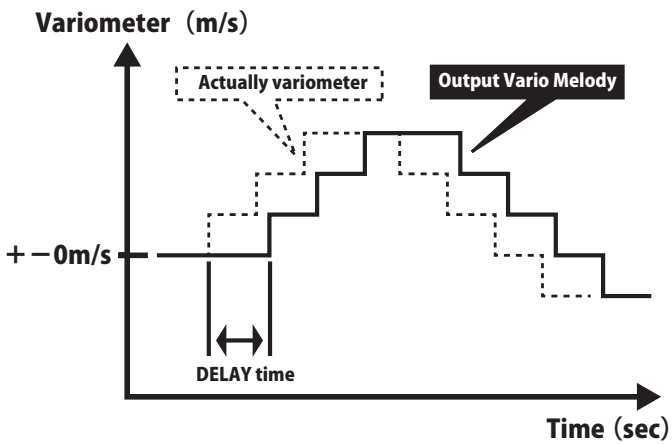

TELEMETRY : BATTERY

Displaying data from the battery voltage
***SBS-01V must be installed in the aircraft.**

In this screen, the battery voltage is displayed.
 In order to use this function, it is necessary to connect external voltage connector of R3008SB ⇄ SBS-01V ⇄ Battery

*It cannot be used in S-FHSS mode

SBS-01V measures two batteries. The drive battery connected to two lines is displayed on EXT-VOLT. The battery for receivers connected to 3P lines is displayed here.

- Select [BATTERY] in the TELEMETRY screen and access the setup screen shown below by pushing the RTN button.

- The maximum and the minimum when powering ON are shown.

- Select the function name and return to the Linkage menu by pushing the RTN button or pushing the HOME/EXIT button.

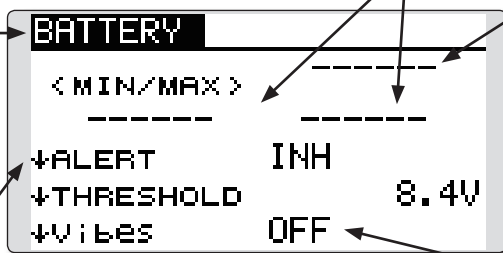

<Push Dial>

- battery voltage
- Scrolling
 - Moving cursor
 - Selecting mode
 - Adjusting value
- To input data mode
- Data is entered
- To next page

- ↓The arrow will indicate that an alarm will sound when the voltage drops to below the setting.

Alert set

1. Move the cursor to the ↓ALERT [INH] item and push the RTN button to switch to the data input mode.
2. Select the ACT mode by scrolling the Push dial.
3. Push the RTN button. (To terminate the input and return to the original state, push the S1 button.)
4. Move the cursor to the ↓THRESHOLD [4.0V] item and push the RTN button to switch to the data input mode.
5. Adjust the rate by scrolling the Push dial.
 Initial value: 4.0V
 Adjustment range: 0.0V~8.4V
 *When the RTN button is pushed for one second, the rate is reset to the initial value.
6. Push the RTN button. (To terminate the input and return to the original state, push the S1 button.)

"Vibes" type

If the following types are selected, the transmitter will vibrate during the warning.

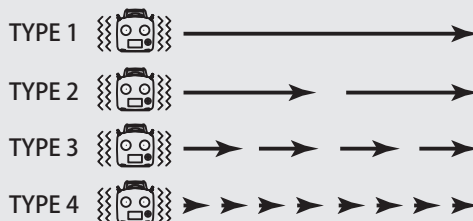

TELEMETRY : DISTANCE

The Distance screen displays and sets altitude data from an SBS-01G/02G GPS Sensor (sold separately), and allows the distance to the airborne aircraft to be read by the transmitter. When the aircraft flies inside or outside the set distance an alarm and vibration alerts the pilot.

Displaying data from the Distance Screen

***A GPS sensor must be installed in the aircraft.**

*The GPS sensor is necessary, and is sold separately. Mount and connect the sensor in accordance with the sensor instruction manual.

*It cannot be used in S-FHSS mode

- This indicates the receiving accuracy from a GPS satellite. When three bars are displayed, the GPS is ready for use. Pushing [REFERENCE] sets the current aircraft position as the starting point.
- Select [DISTANCE] in the TELEMETRY screen and access the setup screen shown below by pushing the RTN button.
- Select the function name and return to the Linkage menu by pushing the RTN button or pushing the HOME/EXIT button.
- The ↑arrow shows that an alarm is generated when the set value is exceeded.
- The ↓arrow shows that an alarm is generated when the distance drops below the set value.
- Push the S1 button to advance to the next page.
- This indicates Maximum Distance the aircraft flew to.
- Current distance
- Distance alarm setting range 1m ~ 5,000m
*Alarm when the aircraft moves far away. (↑THRESHOLD > ↓THRESHOLD)
- Distance alarm setting range 0m ~ 4,999m
(↑THRESHOLD > ↓THRESHOLD)

"Vibes" type
If the following types are selected, the transmitter will vibrate during the warning.

TYPE 1		→
TYPE 2		→ →
TYPE 3		→ → → →
TYPE 4		→ → → → → →

Setting the reference position

1. Turn on the transmitter and the model with the GPS sensor installed in it.
2. Wait for the GPS accuracy indicator to display three bars.
3. Move the cursor to REFERENCE [SET] and push the RTN button. The model's current position is now stored and the distance is set to 0 yd.
4. Push the RTN button. (To terminate the input and return to the original state, push the S1 button.)

*Now, the position of the present model was set to 0 m.

Setting a "too far" alert distance

1. Move the cursor to the ↑ALERT item and push the RTN button to switch to the data input mode.
2. Select the ACT mode by scrolling the Push dial.
3. Push the RTN button. (To terminate the input and return to the original state, push the S1 button.)

4. Move the cursor to the ↓THRESHOLD [1,000m] item and push the RTN button to switch to the data input mode.

5. Adjust the distance by scrolling the Push dial.

*When the RTN button is pushed for one second, the rate is reset to the initial value.

6. Push the RTN button. (To terminate the input and return to the original state, push the S1 button.)

*Positioning time of GPS

A short time is required until the positioning of the GPS is established. In the meantime, don't move the model during this process. Wait until the GPS sensor's LED turns solid green. If it is blinking green it is still acquiring the satellite signals.

Setting a "too close" alert distance.

1. Access the second page by pushing S1. Move the cursor to the ↓ALERT item and push the RTN button to switch to the data input mode.
 2. Select the ACT mode by scrolling the Push dial.
 3. Push the RTN button. (To terminate the input and return to the original state, push the S1 button.)
 4. Move the cursor to the ↓THRESHOLD [0yd] item and push the RTN button to switch to the data input mode.
 5. Adjust the rate by scrolling the Push dial.
 - *When the RTN button is pushed for one second, the rate is reset to the initial value.
 6. Push the RTN button.
- Selecting Surface or Slant distances [DISTANCE] in the TELEMETRY screen by pushing the RTN button once and the S1 button twice.

- Select the function name and return to the Linkage menu by pushing the RTN button or pushing the HOME/EXIT button.

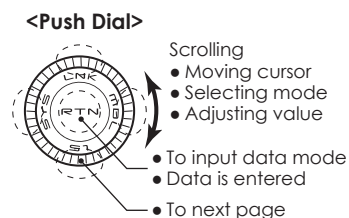
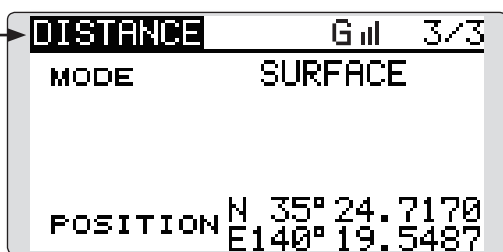

- Current position display.
N: North latitude, E: East longitude

- Altitude calculated as either straight line distance (slant) or surface distance on a map can also be selected (3/3)

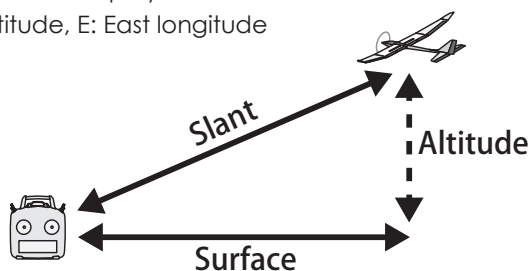

Two distance calculation methods are available Surface (straight line distance), and Slant may be selected.

1. Select page 3 by pushing the S1 button twice from the "DISTANCE" screen.
2. Select <SLANT> <SURFACE> next to "MODE", scroll either to the desired method and push the RTN button.

TELEMETRY : SPEED

The speed screen displays and sets the speed data from an SBS-01G/02G (GPS sensor) sold separately.

The speed of the aircraft during flight can be displayed.

After flight, the maximum speed during flight can be viewed. Because this speed is based on

Displaying data from the speed

***A GPS sensor must be installed in the aircraft.**

position data from a GPS satellite, the ground speed is displayed instead of air speed. Consequently, with a head wind, the displayed speed decreases and with a tail wind, the displayed speed increases.

*It cannot be used in S-FHSS mode

- Select [SPEED] in the TELEMETRY screen and access the setup screen shown below by pushing the RTN button.
- Select the function name and return to the Linkage menu by pushing the RTN button or pushing the HOME/EXIT button.
- Push the S1 button to advance to the next page.
- The ↑ arrow shows that an alarm is generated when the speed exceeds the set value.
- The ↓ arrow shows that an alarm is generated when the speed drops below the set value.

- Displays the maximum speed after the transmitter is turned on.
- Displays the current speed
- Scrolling
 - Moving cursor
 - Selecting mode
 - Adjusting value
- To input data mode
- Data is entered
- To next page
- Speed alarm setting range 1 ~ 500km/h (↑THRESHOLD > ↓THRESHOLD)
 - *Alarm when the speed has increased.
- Speed alarm setting range 0 ~ 499km/h (↑THRESHOLD > ↓THRESHOLD)
 - *Alarm when the speed has decreased.

"Vibes" type

If the following types are selected, the transmitter will vibrate during the warning.

TYPE 1

TYPE 2

TYPE 3

TYPE 4

Alert setting when speed increases

1. Set "↑ALERT" on the <SPEED> screen to ACT. Move the cursor to INH and push the RTN button.
2. Select the ACT mode by scrolling the Push dial.
3. Push the RTN button. (To terminate the input and return to the original state, push the S1 button.)
4. The speed at which an alarm is generated can be set by selecting the speed display next to "↑ THRESHOLD" and pushing the RTN button. This generates an alarm when the speed increases.
5. Adjust the rate by scrolling the Push dial.
 - *When the RTN button is pushed for one second, the rate is reset to the initial value.
6. Push the RTN button. (To terminate the input and return to the original state, push the S1 button.)

Alert setting when speed decreases

1. Select page 2 by pushing S1 from the <SPEED> screen and set "↓ ALERT" to ACT.
2. Select the ACT mode by scrolling the Push dial.

3. Push the RTN button. (To terminate the input and return to the original state, push the S1 button.)
4. The speed at which an alarm is generated can be set by selecting the numerical display next to " ↓ THRESHOLD" and pushing the RTN button. This sounds an alarm when the speed decreases.
5. Adjust the rate by scrolling the Push dial.
 - *When the RTN button is pushed for one second, the rate is reset to the initial value.
6. Push the RTN button. (To terminate the input and return to the original state, push the S1 button.)

*Speed alarm precaution

Since the GPS speed sensor displays the ground speed, it cannot be used as a stall alarm. For example, an aircraft that stalls at 50km/h will stall if the tailwind is 5km/h or greater even through 55km/h is displayed by ground speed. In addition, with an aircraft that will disintegrate in midflight at 400km/h at an over-speed alarm, when the headwind reaches 30km/h the airplane will disintegrate in midair due to over speeding even at a ground speed of 370km/h.

TELEMETRY : Servo sensor [Current]

The SBS-01S can monitor and display the in-flight current, operating angle, and internal temperature of up to two S.BUS2 servos.

If you forget to connect the servo wiring during fuselage assembly, or the servo was disconnected, an alarm can be activated at the transmitter.

Displaying data from the S.BUS servo

***SBS-01S must be installed in the aircraft.**

*It cannot be used in S-FHSS mode



When it's servo 2, select #2.

- Select [CURR.#1] in the TELEMETRY screen and access the setup screen shown below by pushing the RTN button.
- Select the function name and return to the Linkage menu by pushing the RTN button or pushing the HOME/EXIT button.
- ↑ An upward arrow indicates the alarm will sound when the current reaches above your set value.
- ↓ A downward arrow indicates the alarm will sound when the current reaches below your set value.

Displays the maximum/minimum data after the transmitter is turned on.

Displays the current data

<Push Dial>

- Scrolling
- Moving cursor
- Selecting mode
- Adjusting value
- To input data mode
- Data is entered
- To next page

Current alarm setting range 0.1 ~ 10A
(↑THRESHOLD > ↓THRESHOLD)
*Alarm when the current has increased.

"Vibes" type

If the following types are selected, the transmitter will vibrate during the warning.

TYPE 1		→
TYPE 2		→ →
TYPE 3		→ → →
TYPE 4		→ → → →

• Current alarm setting range 0 ~ 9.9A
(↑THRESHOLD > ↓THRESHOLD)
*Alarm when the current has decreased.

Alert setting when servo #1 current increases

- Set "↑ALERT" on the <CURR.#1> screen to ACT. Move the cursor to INH and push the RTN button.
- Select the ACT mode by scrolling the Push dial.
- Push the RTN button. (To terminate the input and return to the original state, push the S1 button.)
- The current at which an alarm is generated can be set by selecting the current display next to "↑ THRESHOLD" and pushing the RTN button. This generates an alarm when the current increases.
- Adjust the rate by scrolling the Push dial.
*When the RTN button is pushed for one second, the rate is reset to the initial value.
- Push the RTN button. (To terminate the input and return to the original state, push the S1 button.)

Alert setting when servo #1 current decreases

- Select page 2 by pushing S1 from the <CURR.#1> screen and set "↓ ALERT" to ACT.
- Select the ACT mode by scrolling the Push dial.
- Push the RTN button. (To terminate the input and return to the original state, push the S1 button.)
- The current at which an alarm is generated can be set by selecting the numerical display next to " ↓ THRESHOLD" and pushing the RTN button. This sounds an alarm when the current decreases.
- Adjust the rate by scrolling the Push dial.
*When the RTN button is pushed for one second, the rate is reset to the initial value.
- Push the RTN button. (To terminate the input and return to the original state, push the S1 button.)

TELEMETRY : Servo sensor [Temperature]

Displaying data from the S.BUS servo
***SBS-01S must be installed in the aircraft.**

The SBS-01S can monitor and display the in-flight internal temperature of up to two S.BUS2 servos.

*It cannot be used in S-FHSS mode



When it's servo 2, select #2.

- Select [TEMP.#1] in the TELEMETRY screen and access the setup screen shown below by pushing the RTN button.
- Select the function name and return to the Linkage menu by pushing the RTN button or pushing the HOME/EXIT button.
- ↑ An upward arrow indicates the alarm will sound when the temperature reaches above your set value.
- ↓ A downward arrow indicates the alarm will sound when the temperature reaches below your set value.

Displays the maximum/minimum data after the transmitter is turned on.

Displays the current data

<Push Dial>

- Scrolling
 - Moving cursor
 - Selecting mode
 - Adjusting value
- To input data mode
- Data is entered
- To next page

Temp alarm setting range -9 ~ 115°C
 (↑THRESHOLD > ↓THRESHOLD)
 *Alarm when the temp has increased.

"Vibes" type

If the following types are selected, the transmitter will vibrate during the warning.

TYPE 1		→
TYPE 2		→ →
TYPE 3		→ → → →
TYPE 4		→ → → → → →

Temp alarm setting range -10 ~ 114°C
 (↑THRESHOLD > ↓THRESHOLD)
 *Alarm when the temp has decreased.

Alert setting when servo #1 temperature increases

- Set "↑ALERT" on the <TEMP.#1> screen to ACT. Move the cursor to INH and push the RTN button.
- Select the ACT mode by scrolling the Push dial.
- Push the RTN button. (To terminate the input and return to the original state, push the S1 button.)
- The temperature at which an alarm is generated can be set by selecting the temperature display next to "↑ THRESHOLD" and pushing the RTN button. This generates an alarm when the temperature increases.
- Adjust the rate by scrolling the Push dial.
 *When the RTN button is pushed for one second, the rate is reset to the initial value.
- Push the RTN button. (To terminate the input and return to the original state, push the S1 button.)

Alert setting when servo #1 temperature decreases

- Select page 2 by pushing S1 from the <TEMP.#1> screen and set " ↓ALERT" to ACT.
- Select the ACT mode by scrolling the Push dial.
- Push the RTN button. (To terminate the input and return to the original state, push the S1 button.)
- The temperature at which an alarm is generated can be set by selecting the numerical display next to " ↓ THRESHOLD" and pushing the RTN button. This sounds an alarm when the temperature decreases.
- Adjust the rate by scrolling the Push dial.
 *When the RTN button is pushed for one second, the rate is reset to the initial value.
- Push the RTN button. (To terminate the input and return to the original state, push the S1 button.)

TELEMETRY : Servo sensor [Angle]

The SBS-01S can monitor and display the in-flight angle and internal temperature of up to two S.BUS2 servos.

If you forget to connect the servo wiring during fuselage assembly, or the servo was disconnected, an alarm can be activated at the transmitter.

Displaying data from the S.BUS servo
***SBS-01S must be installed in the aircraft.**

*It cannot be used in S-FHSS mode

- Select [ANGLE #1] in the TELEMETRY screen and access the setup screen shown below by pushing the RTN button.
- Select the function name and return to the Linkage menu by pushing the RTN button or pushing the HOME/EXIT button.
- An upward arrow indicates the alarm will sound when the angle reaches above your set value.
- A downward arrow indicates the alarm will sound when the angle reaches below your set value.

When it's servo 2, select #2.

- Displays the maximum/minimum data after the transmitter is turned on.
- Displays the angle data
- Scrolling
 - Moving cursor
 - Selecting mode
 - Adjusting value
- To input data mode
- Data is entered
- To next page
- Angle alarm setting range -179.9 ~ +180°
 (↑THRESHOLD > ↓THRESHOLD)
 *Alarm when the angle has increased.

"Vibes" type

If the following types are selected, the transmitter will vibrate during the warning.

TYPE 1		→
TYPE 2		→ →
TYPE 3		→ → →
TYPE 4		→ → → → →

- Angle alarm setting range -180 ~ +179.9°
 (↑THRESHOLD > ↓THRESHOLD) *Alarm when the angle has decreased.

Alert setting when servo #1 angle increases

1. Set "↑ALERT" on the <ANGLE#1> screen to ACT. Move the cursor to INH and push the RTN button.
2. Select the ACT mode by scrolling the Push dial.
3. Push the RTN button. (To terminate the input and return to the original state, push the S1 button.)
4. The angle at which an alarm is generated can be set by selecting the angle display next to "↑THRESHOLD" and pushing the RTN button. This generates an alarm when the angle increases.
5. Adjust the rate by scrolling the Push dial.
 *When the RTN button is pushed for one second, the rate is reset to the initial value.
6. Push the RTN button. (To terminate the input and return to the original state, push the S1 button.)

Alert setting when servo #1 angle decreases

1. Select page 2 by pushing S1 from the <ANGLE#1> screen and set "↓ALERT" to ACT.
2. Select the ACT mode by scrolling the Push dial.
3. Push the RTN button. (To terminate the input and return to the original state, push the S1 button.)
4. The angle at which an alarm is generated can be set by selecting the numerical display next to "↓THRESHOLD" and pushing the RTN button. This sounds an alarm when the angle decreases.
5. Adjust the rate by scrolling the Push dial.
 *When the RTN button is pushed for one second, the rate is reset to the initial value.
6. Push the RTN button. (To terminate the input and return to the original state, push the S1 button.)

Connect Alarm setting

If you forget to connect the servo wiring during fuselage assembly, or the servo was disconnected, an alarm can be activated at the transmitter.

*This alarm and display is limited to the S.BUS servos connected to the servo sensors.

1. Set "CONNECTION" on the <ANGLE> screen to ACT. Move the cursor to INH and push the RTN button.
2. Select the ACT mode by scrolling the Push dial.
3. Push the RTN button.

TELEMETRY : Current sensor [Current]

Displaying data from the drive battery current
*SBS-01C must be installed in the aircraft.

The SBS-01C has the capability of measuring current, voltage and capacity (consumption) from drive battery all at the same time.

*It cannot be used in S-FHSS mode

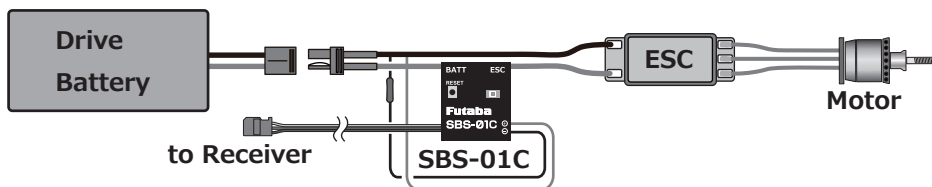

- Select [CURRENT] in the TELEMETRY screen and access the setup screen shown below by pushing the RTN button.
- Select the function name and return to the Linkage menu by pushing the RTN button or pushing the HOME/EXIT button.
- ↑ An upward arrow indicates the alarm will sound when the current reaches above your set value.
- ↓ A downward arrow indicates the alarm will sound when the current reaches below your set value.
- Push the S1 button to advance to the next page.

CURRENT 1/2

< MIN/MAX > 1/2

+0A +0A

↑ALERT INH

↑THRESHOLD +100A

↑Vibes OFF

• Displays the maximum/minimum data after the transmitter is turned on.

• Displays the current data

<Push Dial>

Scrolling

- Moving cursor
- Selecting mode
- Adjusting value

• To input data mode

• Data is entered

• To next page

• Current alarm setting range -150A ~ 150A (↑THRESHOLD > ↓THRESHOLD)
*Alarm when the current has increased.

CURRENT 2/2

↑ALERT INH

↓THRESHOLD +0A

↓Vibes OFF

SPEECH INH --

"Vibes" type

If the following types are selected, the transmitter will vibrate during the warning.

TYPE 1 →

TYPE 2 → →

TYPE 3 → → →

TYPE 4 → → → →

• Current alarm setting range -150A ~ 150A (↑THRESHOLD > ↓THRESHOLD)
*Alarm when the current has decreased.

Alert setting when current increases

- Set "↑ALERT" on the <CURRENT> screen to ACT. Move the cursor to INH and push the RTN button.
- Select the ACT mode by scrolling the Push dial.
- Push the RTN button. (To terminate the input and return to the original state, push the S1 button.)
- The current at which an alarm is generated can be set by selecting the current display next to "↑ THRESHOLD" and pushing the RTN button. This generates an alarm when the current increases.
- Adjust the rate by scrolling the Push dial.
*When the RTN button is pushed for one second, the rate is reset to the initial value.
- Push the RTN button. (To terminate the input and return to the original state, push the S1 button.)

Alert setting when current decreases

- Select page 2 by pushing S1 from the <CURRENT> screen and set " ↓ALERT" to ACT.
- Select the ACT mode by scrolling the Push dial.
- Push the RTN button. (To terminate the input and return to the original state, push the S1 button.)
- The current at which an alarm is generated can be set by selecting the numerical display next to " ↓ THRESHOLD" and pushing the RTN button. This sounds an alarm when the current decreases.
- Adjust the rate by scrolling the Push dial.
*When the RTN button is pushed for one second, the rate is reset to the initial value.
- Push the RTN button. (To terminate the input and return to the original state, push the S1 button.)

TELEMETRY : Current sensor [Voltage]

Displaying data from the drive battery voltage
***SBS-01C must be installed in the aircraft.**

The SBS-01C has the capability of measuring current, voltage and capacity (consumption) from drive battery all at the same time.

*It cannot be used in S-FHSS mode

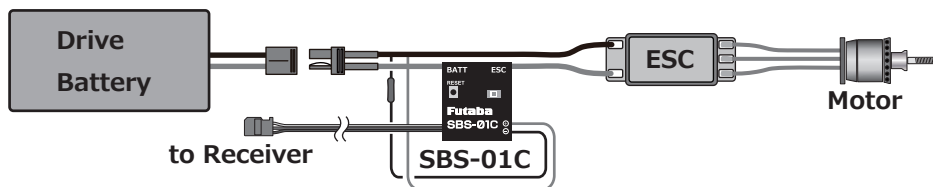

- Select [VOLTAGE] in the TELEMETRY screen and access the setup screen shown below by pushing the RTN button.
- Select the function name and return to the Linkage menu by pushing the RTN button or pushing the HOME/EXIT button.
- Displays the maximum/minimum data after the transmitter is turned on.
- Displays the voltage data
- Scrolling
 - Moving cursor
 - Selecting mode
 - Adjusting value
- To input data mode
- Data is entered
- To next page
- Voltage alarm setting range 0.0V ~ 70.0V (↑THRESHOLD > ↓THRESHOLD)
 *Alarm when the voltage has increased.
- ↑ An upward arrow indicates the alarm will sound when the voltage reaches above your set value.
- ↓ A downward arrow indicates the alarm will sound when the voltage reaches below your set value.
- Push the S1 button to advance to the next page.
- Voltage alarm setting range 0.0V ~ 70.0V (↑THRESHOLD > ↓THRESHOLD)
 *Alarm when the voltage has decreased.

"Vibes" type

If the following types are selected, the transmitter will vibrate during the warning.

TYPE 1 →

TYPE 2 → →

TYPE 3 → → →

TYPE 4 → → → →

Alert setting when voltage increases

- Set "↑ALERT" on the <VOLTAGE> screen to ACT. Move the cursor to INH and push the RTN button.
- Select the ACT mode by scrolling the Push dial.
- Push the RTN button. (To terminate the input and return to the original state, push the S1 button.)
- The voltage at which an alarm is generated can be set by selecting the voltage display next to "↑ THRESHOLD" and pushing the RTN button. This generates an alarm when the voltage increases.
- Adjust the rate by scrolling the Push dial.
 *When the RTN button is pushed for one second, the rate is reset to the initial value.
- Push the RTN button. (To terminate the input and return to the original state, push the S1 button.)

Alert setting when voltage decreases

- Select page 2 by pushing S1 from the <VOLTAGE> screen and set "↓ALERT" to ACT.
- Select the ACT mode by scrolling the Push dial.
- Push the RTN button. (To terminate the input and return to the original state, push the S1 button.)
- The voltage at which an alarm is generated can be set by selecting the numerical display next to "↓ THRESHOLD" and pushing the RTN button. This sounds an alarm when the voltage decreases.
- Adjust the rate by scrolling the Push dial.
 *When the RTN button is pushed for one second, the rate is reset to the initial value.
- Push the RTN button. (To terminate the input and return to the original state, push the S1 button.)

TELEMETRY : Current sensor [Capacity]

Displaying data from the drive battery capacity
***SBS-01C must be installed in the aircraft.**

The SBS-01C has the capability of measuring current, voltage and capacity (consumption) from drive battery all at the same time.

*It cannot be used in S-FHSS mode

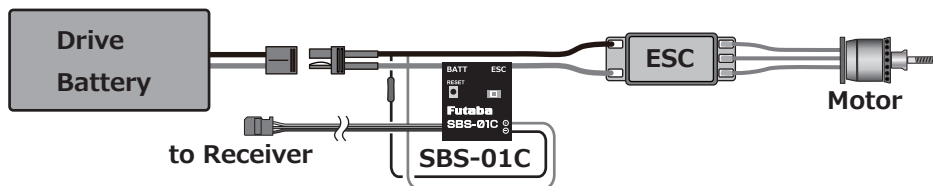

- Select [CAPACITY] in the TELEMETRY screen and access the setup screen shown below by pushing the RTN button.
- Select the function name and return to the Linkage menu by pushing the RTN button or pushing the HOME/EXIT button.
- Displays the maximum/minimum data after the transmitter is turned on.
- Displays the capacity data
- Capacity alarm setting range -32,000mAh ~ -32,000mAh (↑THRESHOLD > ↓THRESHOLD)
 *Alarm when the capacity has increased.
- Capacity alarm setting range -32,000mAh ~ -32,000mAh (↑THRESHOLD > ↓THRESHOLD)
 *Alarm when the capacity has decreased.

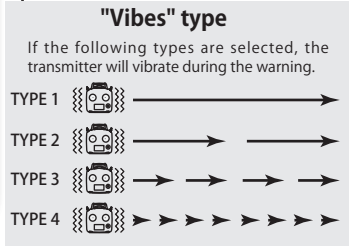
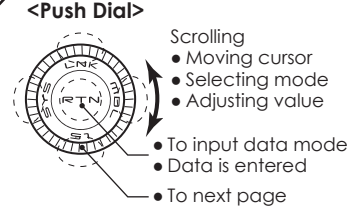
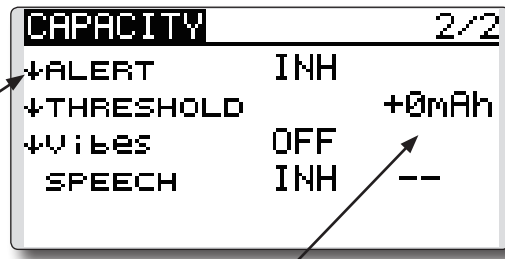
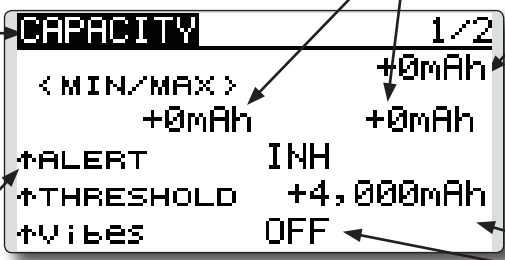

Alert setting when capacity increases

1. Set "↑ALERT" on the <CAPACITY> screen to ACT. Move the cursor to INH and push the RTN button.
2. Select the ACT mode by scrolling the Push dial.
3. Push the RTN button. (To terminate the input and return to the original state, push the S1 button.)
4. The capacity at which an alarm is generated can be set by selecting the capacity display next to "↑ THRESHOLD" and pushing the RTN button. This generates an alarm when the capacity increases.
5. Adjust the rate by scrolling the Push dial.
 *When the RTN button is pushed for one second, the rate is reset to the initial value.
6. Push the RTN button. (To terminate the input and return to the original state, push the S1 button.)

Alert setting when capacity decreases

1. Select page 2 by pushing S1 from the <CAPACITY> screen and set " ↓ ALERT" to ACT.
2. Select the ACT mode by scrolling the Push dial.
3. Push the RTN button. (To terminate the input and return to the original state, push the S1 button.)
4. The capacity at which an alarm is generated can be set by selecting the numerical display next to " ↓ THRESHOLD" and pushing the RTN button. This sounds an alarm when the capacity decreases.
5. Adjust the rate by scrolling the Push dial.
 *When the RTN button is pushed for one second, the rate is reset to the initial value.
6. Push the RTN button. (To terminate the input and return to the original state, push the S1 button.)

SENSOR

Various telemetry sensors setting

This screen registers the telemetry sensors used with the transmitter. When only one of a certain type of sensor is used, this setting is unnecessary and the sensor can be used by simply connecting it to the S.BUS2 port of the transmitter.

When using 2 or more of the same kind of sensor, they must be registered here.

- Select [SENSOR] in the Linkage menu and access the setup screen shown below by pushing the RTN button.

*3 slots of altitude sensor are used.
*8 slots of GPS sensor are used.

[What is a slot?]

Servos are classified by CH, but **sensors** are classified in units called “slot”. There are **slots** from **No. 1** to **No. 31**.

Altitude sensors, GPS sensors and other data sensor units may use **multiple slots**.

When using a sensor which requires two or more slots, the number of slots is automatically assigned by setting up a **start slot**.

When 2 or more of the same kind of sensor are used, the sensors themselves must allocate unused slots and memorize that slot.

<Push Dial>

- Scrolling
- Moving cursor
- Selecting mode
- Adjusting value
- To input data mode
- Data is entered
- To next page

- Sensor ID: When multiple sensors of the same type are not used, ID is unnecessary.
- As shown in the table below, an altimeter requires 3 contiguous slots and a GPS sensor requires 8 contiguous slots. In addition, since the GPS (SBS-01G/02G) start slots are 8, 16, and 24, slots 6 and 7 are inhibited.

< Assignable slot > *Altimeter, GPS, and other sensors that display a large amount of data require multiple slots.
*Depending on the type of sensor, the slot numbers that can be allocated may be limited.

Sensor	The required number of slots	The number which can be used as a start slot	Selling area
SBS-01T/TE/TE(TEMP)	1 slot	1 ~ 31	Global
SBS-01RM/RO/RB(RPM)	1 slot	1 ~ 31	
SBS-01V(Voltage)	2 slots	1, 2, 3, 4, 5, 6, 8, 9, 10, 11, 12, 13, 14, 16, 17, 18, 19, 20, 21, 22, 24, 25, 26, 27, 28, 29, 30	
SBS-01A/02A(Altitude)	3 slots	1, 2, 3, 4, 5, 8, 9, 10, 11, 12, 13, 16, 17, 18, 19, 20, 21, 24, 25, 26, 27, 28, 29	
SBS-01C	3 slots	1, 2, 3, 4, 5, 8, 9, 10, 11, 12, 13, 16, 17, 18, 19, 20, 21, 24, 25, 26, 27, 28, 29	
SBS-01S(S.BUS servo)	6 slots	1, 2, 8, 9, 10, 16, 17, 18, 24, 25, 26	
SBS-01G/02G(GPS)	8 slots	8, 16, 24	Europe
Robbe TEMP125-F1713	1 slot	1 ~ 31	
Robbe VARIO-F1712	2 slots	1, 2, 3, 4, 5, 6, 8, 9, 10, 11, 12, 13, 14, 16, 17, 18, 19, 20, 21, 22, 24, 25, 26, 27, 28, 29, 30	
Robbe VARIO-F1672	2 slots	1, 2, 3, 4, 5, 6, 8, 9, 10, 11, 12, 13, 14, 16, 17, 18, 19, 20, 21, 22, 24, 25, 26, 27, 28, 29, 30	
Robbe CURR-F1678	3 slots	1, 2, 3, 4, 5, 8, 9, 10, 11, 12, 13, 16, 17, 18, 19, 20, 21, 24, 25, 26, 27, 28, 29	
Robbe GPS-F1675	8 slots	8, 16, 24	
Robbe True Airspeed Sensor 450	1 slot	1 ~ 31	
Castle-TL0	8 slots	8, 16, 24	
Kontronik	8 slots	8, 16, 24	
PowerBox	16 slots	8, 16	

SENSOR : RELOAD

This page is set when using multiple telemetry sensors of the same type.

When using multiple sensors of the same type the sensors must be registered in the transmitter. Connect all the sensors to be used to the T12K as shown in the figure at the right and register them by the following procedure. The ID of each sensor is registered in the transmitter.

- Call page 7 by pushing the S1 button 6 times from the [SENSOR] menu.

- Select the function name and return to the Linkage menu by pushing the RTN button or pushing the HOME/EXIT button.

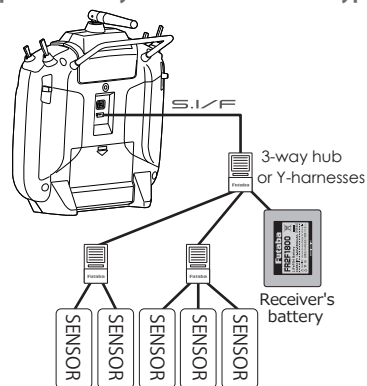
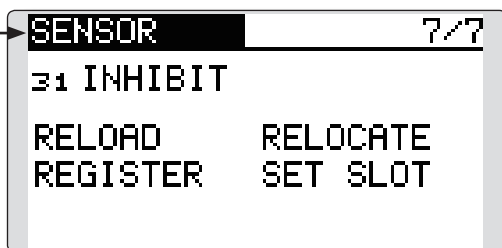

All the sensors to be used are connected.

<Push Dial>

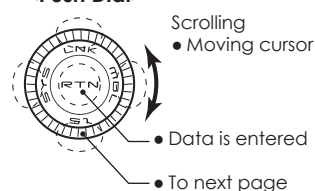

Reading all the sensors to be used

1. Connect all the sensors and receiver batteries to be used to the T12K through a hub as shown in the figure above.
2. Move the cursor to "RELOAD" on page 7 of the [SENSOR] screen.
3. Push the RTN button.
All the sensors are registered and can be used.

SENSOR : REGISTER

This page is set when using multiple telemetry sensors of the same type.

This function registers an additional sensor. Connect the sensor as shown in the figure at the right and register it by the following procedure. The sensor ID is registered in the transmitter.

Additional sensor registration

1. Connect the sensor and receiver battery to be used to the T12K through a hub as shown in the figure at the right.
2. Move the cursor to "REGISTER" on page 7 of the <Sensor> screen.
3. Push the RTN button.

The sensor is registered and can be used.

*When the number of slots needed in registration is insufficient, an error is displayed and registration cannot be performed. Disable unused slots or perform the following relocate.

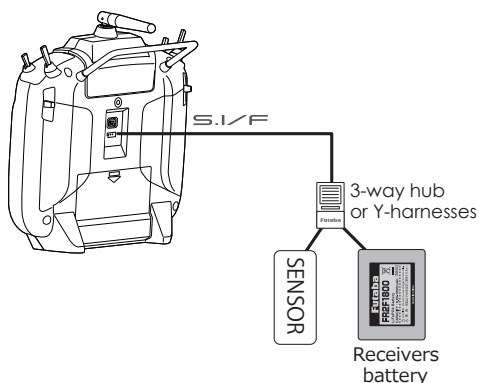

SENSOR : RELOCATE Follow these instructions when using multiple telemetry sensors of the same type.

Use this function when repeated registration and deregistration of slots has left open slots fragmented and unusable. It rearranges them into contiguous unused slots.

- Call page 7 by pushing the S1 button 6 times from the [SENSOR] menu.

- Select the function name and return to the Linkage menu by pushing the RTN button or pushing the HOME/EXIT button.

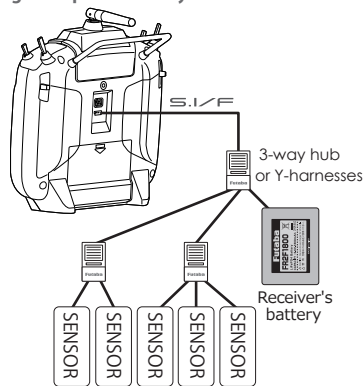
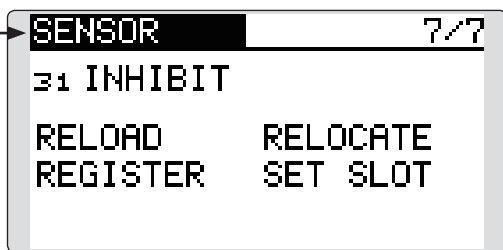

All the sensors to be used are connected.

<Push Dial>

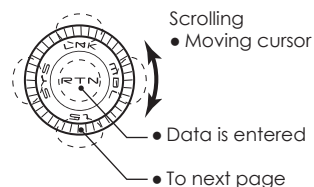

Relocate of sensors to be used

1. Connect all the sensors and receiver batteries to be used to the T12K through a hub as shown in the figure above.
2. Move the cursor to "RELOCATE" on page 7 of the [SENSOR] screen.
3. Push the RTN button.

SENSOR : SET SLOT This page is for using multiple telemetry sensors of the same type.

This procedure changes the slot number of one registered sensor.

Sensor slot change

1. Connect the sensor and receiver battery to be changed to the T12K through a hub as shown in the figure above.
2. Move the cursor to "SET SLOT" on page 7 of the <Sensor> screen.
3. Push the RTN button. A sensor details screen appears.
4. Move the cursor to "LOAD" and push the RTN button.
5. The current start slot is displayed. Move the cursor to the number of the start slot and change it to the desired value. (Cannot be set to a slot that cannot be allocated like the table of all pages.)
6. Move the cursor to "WRITE" and push the RTN button.

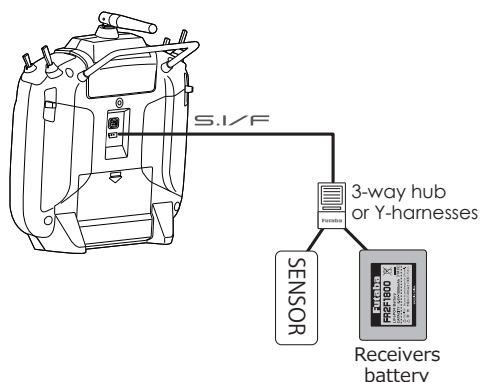

DATA RESET

Model memory setting data reset.

This function is designed to allow you to reset trim settings or all of the settings saved in the active model memory. You may individually choose to reset the following data:

T1~T4:

Reset the digital trim setting.

*The trim step amount and trim rate are not reset.

- Select [DATA RESET] in the Linkage menu and access the setup screen shown below by pushing the RTN button.

- Select the function name and return to the Linkage menu by pushing the RTN button or pushing the HOME/EXIT button.

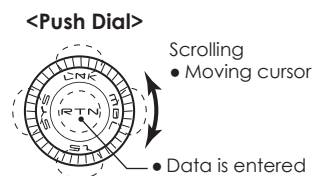
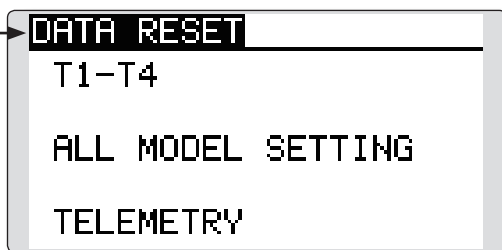

All model setting:

Resets all Linkage and Model Menu functions except for system and low battery voltage, Model Select and Model Type.

*If the Model Type selected is Glider, the motor function channel is automatically reversed in the Reverse menu; all other channels remain normal.

TELEMETRY:

Reset the telemetry setting.

Data resetting method

1. Move the cursor to the item you want to reset and push the RTN button.

*A confirmation message appears.

2. Execute reset by pushing the RTN button for one second. (Push the S1 button to cease resetting.)

[T1-T4]: Resets only the T1-T4

[ALL MODEL SETTING]: Resets all Linkage and Model Menu functions except for system and low battery voltage, Model Select and Model Type.

[TELEMETRY]: Resets only the telemetry functions.

MODEL MENU (COMMON FUNCTIONS)

This section describes the D/R, program mixing, and other functions common to all model types.

Before setting the model data, use the Model Type function of the Linkage menu to select the model type matched to the aircraft. If a different model type is selected afterwards, the D/R, program mixing, and other parameters are reset.

If either a helicopter or glider have been selected as the model type, then the specific functions in the Model menu can be set for each flight condition. If you want to switch the settings for each condition by switch, stick position, etc., use the Condition

Select function to add flight conditions. (Up to five conditions can be used)

Note: The T12K is designed so that the airplane and glider (including EP glider) model types are compatible with aircraft of similar type wings.

This section outlines the relationship between the functions common to airplanes and gliders, except some dedicated functions, and model type.

The setting menus will depend on the number of servos and other differences according to the wing type used. The setup screens in the instruction manual are typical examples.

- Call the model menu shown below with a long push of the MDL button at the home screen, etc.

- Select the function name and return to the Model menu by pushing the RTN button or pushing the HOME/EXIT button.

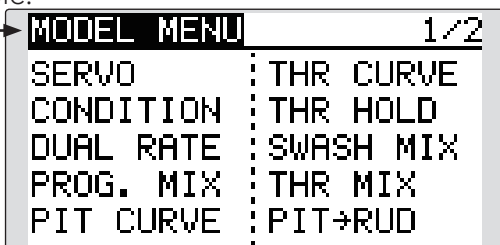

<Push Dial>

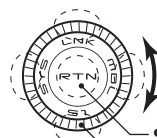

Scrolling
• Moving cursor

• Calling setup screen

• To next page

- Select the function you want to set and access the setup screen by pushing the RTN button.

*The Model menu screen depends on the model type.

Model Menu functions (Common) list

•SERVO

Servo test and servo position display (For a description of its functions, see the Linkage Menu section.)

•CONDITION (applicable to helicopter and glider selections)

Flight conditions addition, deletion, copy, condition renaming, and condition delay can be set.

•DUAL RATE

The D/R curve of a T12K transmitter may be activated from a switch, stick, position, etc. For information on how to do so, please refer to the Switch Setting Method located at the back of this manual.

•PROG. MIX

The T12K transmitter allows up to five completely customizable program mixes.

CONDITION

Flight condition's switch assignment, copy, priority change and condition delay can be set [except airplane type].

This function, in the Model menu, can be used to switch the settings of up to 5 flight conditions. Please note this is not applicable to airplane type selections.

Note: To prevent accidental activation of any unused flight conditions during flight, set the switch setting of those unused conditions to null [--].

- A Condition Delay function can be set to prevent unnecessary fuselage motion which may be generated when there are sudden changes in the servo positions and when there are variations in the operating time between channels during condition switching. The delay can be set for each channel to ensure maximum performance from your aircraft.
- Select [CONDITION] at the Model menu and access the setup screen shown below by pushing the RTN button.

When setting the delay function for a specific flight condition, the related function changes after a delay corresponding to the set amount.

- If multiple conditions were set, their operational priority may be customized as desired.

(Currently selected condition name)

- Select the function name and return to the Model menu by pushing the RTN button or pushing the HOME/EXIT button.



CONDITION	NORMAL		1/3
▶ NORMAL	OFF		
IDLEUP1	SE	TYPE1	↕
IDLEUP2	SE	TYPE2	↕
IDLEUP3	SF	TYPE3	↕
HOLD	SG	TYPE4	↕

(Condition name) (Condition switch)

<Push Dial>

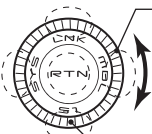

- Scrolling
- Moving cursor
- Selecting mode
- Adjusting value

• To next page

Condition switch selection/deletion

1. Move the cursor to the switch item of the condition you want to select/delete and access the switch setup screen by pushing the RTN button and select the switch and ON direction.

*For a detailed description of the setting method, see [Switch Setting Method] at the back of this manual.

Condition copy

CONDITION	NORMAL		3/3
DELAY	SOURCE		
9 GYR2 0	NORMAL		
10 GYR3 0	↕ COPY		
11 AUX1 0	DESTIN.		
12 AUX1 0	IDLEUP1		

(Setup screen page 3)

1. Move the cursor to the [SOURCE] item and push the RTN button to switch to the data input mode.

Select the copy source condition by scrolling the Push dial. Then, push the RTN button.

2. Move the cursor to the [DESTIN.] item and

push the RTN button.

Select the copy destination condition by scrolling the Push dial. Then, push the RTN button.

*The current condition cannot be selected for the copy destination condition.

3. Move the cursor to the [COPY] item and push the RTN button. A confirmation message appears.

*The display blinks.

4. Push the RTN button for one second and the copying is completed. (Push the S1 button to stop copying.)

Priority change

1. Move the cursor to the priority up-arrow or down-arrow you want to change and push the RTN button.

The priority of the corresponding condition is changed. (The last condition becomes the highest priority.)

*The Normal condition cannot be changed or moved. Its priority is always the lowest.

Condition delay setting

CONDITION		NORMAL	2/3
DELAY			
1	AIL	0	5GYRO 0
2	ELE	0	6PIT 0
3	THR	0	7GOV 0
4	RUD	0	8NDL 0

(Setup screen page 2)

1. Select the condition which you want to set.
2. Move the cursor to the "DELAY" icon of the channel you want to set and push the RTN button to switch to the data input mode.
Adjust the delay amount by scrolling the Push dial.
Initial value: 0
Adjustment range: 0~27 (maximum delay)
3. Push the RTN button to end adjustment and return to the cursor mode.

Condition Vibrator

When the condition is changed, it informs by the vibrator.

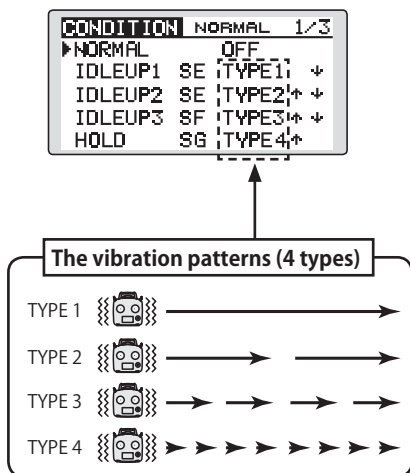

*Condition after switching, the vibrator is activated by a slight delay.

DUAL RATE The angle and curve of each stick function can be set. [All model types]

Dual rate function is used to adjust the amount of throw and the operational curve of the stick functions (aileron, elevator and rudder) for each flight condition or up to 5 rates for each function. For airplane type, it is also possible to adjust the operational curve of the throttle function.

This is normally used after the End Point programming has been completed to define the maximum throw. When mixing is applied from one channel to another channel, both channels can be adjusted at the same time by adjusting the operation

rate through the dual rate function.

Neutral position of the dual rate curve can be set.

Dual rate curve of FLAP, FLAP3, BUTTERFLY, and CAMBER function can be set. (Airplane/Glider)

*FLAP3 and BUTTERFLY are glider only functions.

*EXP rate setting is not allowed in the FLAP, FLAP3, BUTTERFLY, and CAMBER functions.

*Individual switch setting is not allowed in the FLAP, FLAP3, and BUTTERFLY, CAMBER functions. (Condition switching only)

- Select [DUAL RATE] at the Model menu and access the setup screen shown below by pushing the RTN button.

- Function selection

- Select the function name and return to the Model menu by pushing the RTN button or pushing the HOME/EXIT button.



- Neutral position

(Currently selected circuit #)

[Airplane]

• Left/right (up/down) rate

• Operation curve (left/right, up/down)

• Switch selection

*Up to five rates for each function

<Push Dial>

- Scrolling
- Moving cursor
- Selecting mode
- Adjusting value
- To input data mode
- Data is entered
- To next page

[Helicopter/glider]

• Condition selection

• Condition Mode selection

• Switch selection

• Switch mode selection

Dual rate setting procedure

1. Function selection

Move the cursor to the function selection item and push the RTN button to switch to the data input mode.

Select the function you want to adjust by scrolling the Push dial.

Push the RTN button to the cursor mode.

2. Switch selection

Move the cursor to the circuit # item and access the switch setup screen by pushing the RTN button. Select the switch activation method and the activation position (if applicable).

*For a detailed description of the setting method, see [Switch Setting Method] at the back of this manual.

3. Left/right (up/down) rate adjustment

*Perform the settings below after changing to the circuit # or condition you want to adjust.

Move the cursor to the rate item you want to adjust and push the RTN button to switch to the data input mode.

Adjust the rate by scrolling the Push dial.

Initial value: 100%

Adjustment range: 0%~140%

*When the RTN button is pushed for one second, the servo operation position is reset to the initial value.)

Push the RTN button to end the adjustment and return to the cursor mode.

Repeat this procedure for additional rate and other functions as desired.

4. Operation curve (EXP curve) adjustment

*Perform the settings below after changing to the circuit # or condition you want to adjust.

Move the cursor to the EXP item you want to adjust and push the RTN button to switch to the data input mode.

Adjust the rate by scrolling the Push dial.

Initial value: 0%

Adjustment range: -100%~+100%

*When the RTN button is pushed for one second, the servo operation position is reset to the initial value.)

*Using the EXP curve is effective to smooth or soften the control inputs around center to avoid over-controlling the model. This is often used for the ailerons, elevator and rudder and may be used with the throttle in the case of an airplane selection to smooth the engine controls as well.

Push the RTN button to end adjustment and return to the cursor mode.

Repeat this procedure for all other rates and functions as desired.

5. Neutral position adjustment

*Perform the settings below after changing to the circuit # or condition you want to adjust.

Move the cursor to the [NT] item and push the RTN button to switch to the data input mode.

Adjust the rate by scrolling the Push dial.

Initial value: 0%

Adjustment range: -100%~+100%

*When the RTN button is pushed for one second, the neutral position is reset to the initial value.)

Push the RTN button to the cursor mode.

PROG. MIX

Program mixing can be freely customized. Up to five mixings can be used for each model. [All model types]

Programmable mixing may be used to correct undesired tendencies of the aircraft, and it may also be used for unusual control configurations. Mixing means that the motion of a command channel, called the "master," is added to the motion of the mixed channel, called "slave."

You may choose to have the Master's trim added to the Slave channel response ("Trim" setting). The mixing

curve (Linear/5-point) can be changed. You may select Mixing ON/OFF switch, control or you may choose to have mixing remaining on all the time.

The Programmable mixing includes a powerful link function, which allows Programmable mixing to be linked with the special mixing functions, or with other programmable mixing functions. The link function can be set up for Master and Slave channel individually.

- Select [PROG. MIX] at the Model menu and access the setup screen shown below by pushing the RTN button.

- Select the function name and return to the Model menu by pushing the RTN button or pushing the HOME/EXIT button.

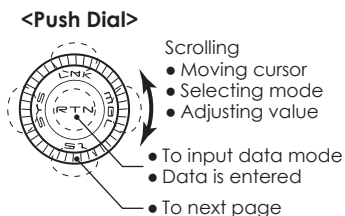
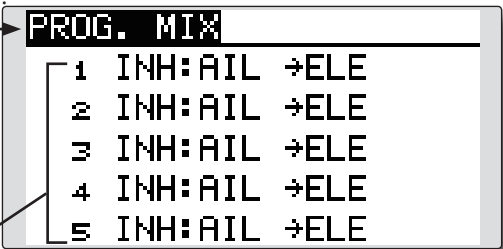

Mix setup screen call

- Move the cursor to the mix # whose function you want to activate and access the setup screen by pushing the RTN button.

- Mixing rate (Left/right, up/down)

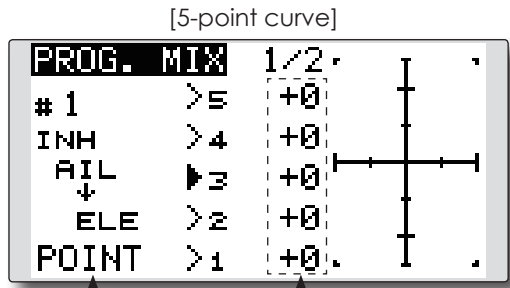
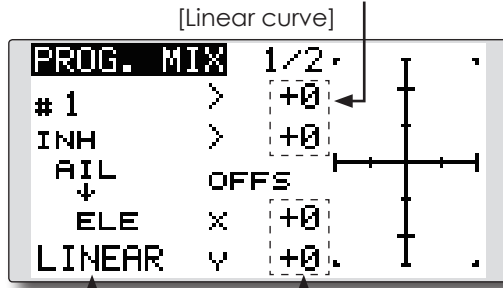

- Curve selection
- Offset rate (X, Y)

- Curve selection
- Point rate (point1-5)

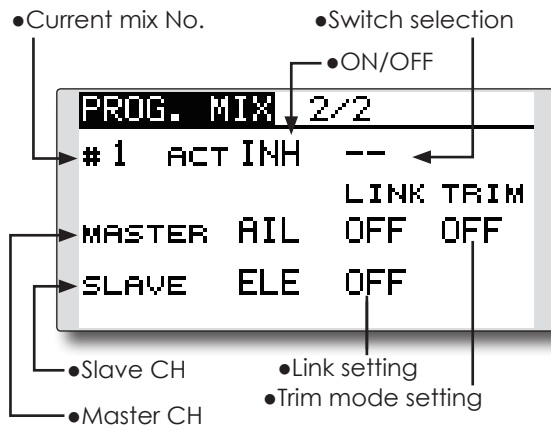

Prog. mix setting procedure

- **Activate the function.**
Move the cursor to the [ACT] item and push the RTN button to switch to the data input mode.
Select the ACT mode by scrolling the Push dial.
*The display blinks.
Push the RTN button to activate the function and return to the cursor mode.
*The function is activated. (ON or OFF display)
*ON/OFF switch and mix rate are not set even though the function is activated.

●ON/OFF switch setting

Move the cursor to the switch item and access the switch setup screen by pushing the RTN button and select the switch and ON direction.

*For a detailed description of the setting method, see [Switch Setting Method] at the back of this manual.

*Always on when [-].

●Master channel setting

1. Move the cursor to the [MASTER] item and push the RTN button to switch to the data input mode.

Select the function by scrolling the Push dial.

*The display blinks.

Push the RTN button to change the function and return to the cursor mode.

2. When you want to link this mixing with other mixes, move the cursor to the [LINK] item and push the RTN button to switch to the data input mode.

Select the link mode, either [+] or [-], by scrolling the Push dial.

*The display blinks.

Push the RTN button to set the link mode and return to the cursor mode.

*Check to ensure that the link mode is functioning properly by operating the mix accordingly.

*Master channel control can be set to activate based on the amount of stick input, or VR input, neither of which includes ATV, D/R, and mixing selection. In this case, the switch setup screen is displayed by pushing the RTN button with "H/W" selected in the function selection. Select master channel control. (To terminate the "H/W" selection, select the [-] display and push the RTN button.)

●Slave channel setting

1. Move the cursor to the [SLAVE] item and push the RTN button to switch to the data input mode.

Select the function by scrolling the Push dial.

*The display blinks.

Push the RTN button to change the function and return to the cursor mode.

2. When you want to link this mixing with other mixes, move the cursor to the [LINK] item and push the RTN button to switch to the data input mode.

Select the link mode to [+] or [-] by scrolling the Push dial.

*The display blinks.

Push the RTN button to set the link mode and return to the cursor mode.

*Check the direction by actual operation.

●Trim mode ON/OFF setting

1. When changing the trim mode, move the cursor to the [TRIM] item and push the RTN button to switch to the data input mode.

Select ON/OFF by scrolling the Push dial.

*The display blinks.

Push the RTN button to change the trim mode ON/OFF and return to the cursor mode.

*To incorporate the mixing from the master trim, select [ON]. If trim is not desired, select [OFF].

*Effective when a function is set in the master channel.

●Linear curve setting

[Rate setting]

1. Move the cursor to the mixing rate setting item and push the RTN button to switch to the data input mode.

Adjust the rate by scrolling the Push dial.

Initial value: 0%

Adjustment range: -100%~+100%

*When the RTN button is pushed for one second, the servo operation position is reset to the initial value.

Push the RTN button to end adjustment and return to the cursor mode.

2. Repeat this procedure for all other rates as desired.

[Offsetting the curve horizontally in the vertical or horizontal direction]

1. Move the cursor to the [OFFS] setting item and push the RTN button to switch to the data input mode.

Adjust the offset rate by scrolling the Push dial.

Initial value: 0%

Adjustment range: -100%~+100%

*When the RTN button is pushed for one second, the servo operation position is reset to the initial value.)

Push the RTN button to end the adjustment and return to the cursor mode.

2. Repeat this procedure for the other direction.

●5-point curve setting

[Rate setting]

1. Move the cursor to the point rate setting item you want to adjust and push the RTN button to switch to the data input mode.

Adjust the rate by scrolling the Push dial.

Initial value: 0%

Adjustment range: -100%~+100%

*When the RTN button is pushed for one second, the servo operation position is reset to the initial value.)

Push the RTN button to end the adjustment and return to the cursor mode.

2. Repeat this procedure for each point as desired.

FUEL MIX

Dedicated mixing used to adjust the fuel mixture of applicable engines. [Airplane/helicopter]

This function is used to refine in-flight needle adjustments of engines that offer mixture control carburetors.

Note: Initial settings do not assign fuel mix to any channel. Prior to using the Fuel Mix settings, select an unused channel on your receiver and assign it accordingly for the mixture control. Additionally, please make sure that your [Control] and [Trim] are set to null [-].

- Select [FUEL MIX] at the Model menu and access the setup screen shown below by pushing the RTN button. [Airplane type]

- Select the function name and return to the Model menu by pushing the RTN button or pushing the HOME/EXIT button.

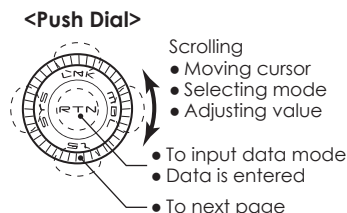
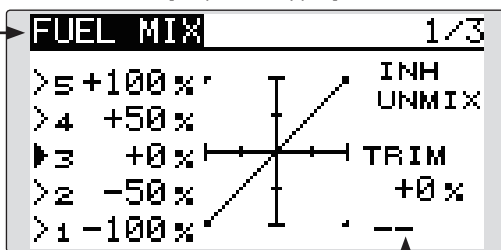

- Needle high trim selection

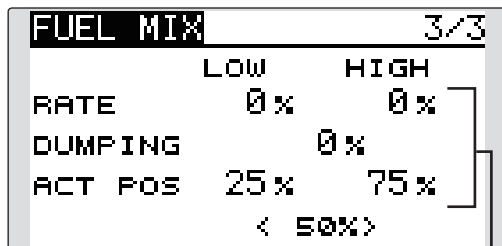
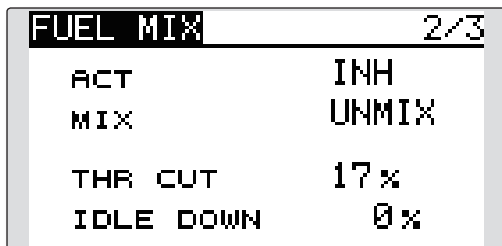

- Acceleration setting

[Helicopter type]

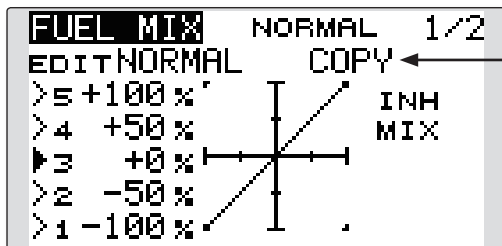

- Mixing curve copy function
- Move the COPY item and push the RTN button to switch to the data input mode. Select the copy destination condition by scrolling the Push dial and push the RTN button. Select [YES] and push the RTN button.

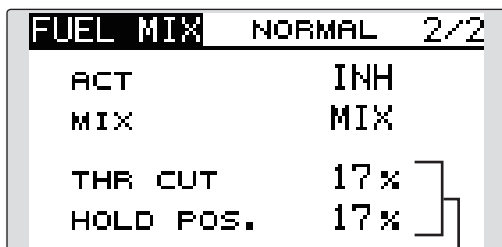

- Engine cut setting

Setting method

*Before using this function, assign the [FUEL MIX] function to an unused channel in the Linkage menu [FUNCTION].

●Activate the function.

1. Move the cursor to the [ACT] item and push the RTN button to switch to the data input mode.

Select the ACT mode by scrolling the Push dial.

*The display blinks.

Push the RTN button to activate the function and return to the cursor mode. (ON is displayed.)

2. Move the cursor to the [MIX] item and push the RTN button to switch to the data input mode.

Select the mixing mode you want to change by scrolling the Push dial.

*The display blinks.

Push the RTN button to change the mode and return to the cursor mode.

*When [MIX] is selected at the [MIX] icon, the throttle curve data that is set becomes the mix master. When [UNMIX] is selected, the throttle stick position becomes the master.

●5-point curve setting

1. Move the cursor to the point rate setting item you want to adjust and push the RTN button to switch to the data input mode.

Adjust the rate by scrolling the Push dial.

Initial value: 0%

Adjustment range: -100%~+100%

*When the RTN button is pushed for one second, the servo operation position is reset to the initial value.)

Push the RTN button to end adjustment and return to the cursor mode.

2. Repeat this procedure for each point.

●Needle high trim setting

1. Move the cursor to the needle high trim selection item and access the switch setup screen by pushing the RTN button. Select the needle high trim lever.

*For a detailed description of the setting method, see [Switch Setting Method] at the back of this manual.

2. Move the cursor to the TRIM rate item and push the RTN button to switch to the data input mode.

Adjust the trim rate by scrolling the Push dial.

Initial value: 0%

Adjustment range: -30%~+30%

*When the RTN button is pushed for one second, the rate is reset to the initial value.)

Push the RTN button to end adjustment and return to the cursor mode.

*Needle high trim works as high trim based on the center. (Works like ATL trim.)

●Acceleration setting (Airplane)

*This function is used to adjust the needle/engine rise characteristics during acceleration. This enables an acceleration function which temporarily increases the needle operation from the throttle stick.

This function is used when there are symptoms of the mixture being too lean or too rich, which would be generated by sudden throttle stick inputs.

[Acceleration rate setting (RATE)]

*Acceleration can be adjusted for both high and low settings.

[Damping rate setting (DUMPING)]

*The return time after operation (Dumping) can be set.

Move the cursor to the rate item you want to change and push the RTN button to switch to the data input mode.

Adjust the rate by scrolling the Push dial.

*When the RTN button is pushed for one second, the rate is reset to the initial value.)

Push the RTN button to end adjustment and return to the cursor mode.

[Operation point setting (ACT POS)]

*The operation point at which the acceleration setting will occur. If this point is exceeded, acceleration is performed.

Move the cursor to the [ACT POS] item and hold the throttle stick to the position you want to change. Push the RTN button for one second.

Note: When using the acceleration function, since the needle stroke is large, adjust your settings so there is no binding of your linkage.

●Engine cut setting

*Operation linked with the throttle hold function, throttle cut function, and idle down function is possible. The throttle cut position can be adjusted accordingly. Set it to the fully closed position.

Move the cursor to the throttle cut or idle down item and push the RTN button to switch to the data input mode.

Adjust the servo position by scrolling the Push dial.

Initial value: THR CUT: 17%, IDLE DOWN: 0%

Adjustment range: THR CUT: 0~50%, IDLE DOWN: 0~100%

*When the RTN button is pushed for one second, the rate is reset to the initial value.)

Push the RTN button to end the adjustment and return to the cursor mode.

MODEL MENU (AIRPLANE/GLIDER FUNCTIONS)

The dedicated mixes, etc. that are applicable when an airplane or glider model type is selected are displayed in this Model Menu functions section. Prior to adjusting any of these mixes, etc. use the Model Type function in the Linkage menu to select the model type, wing type, and tail type matched to the aircraft. Other settings reset the data used in mixing function, etc.

For gliders, many dedicated mixes can be set for each flight condition, as required. To switch the settings for each condition by switch or stick

position, use the Condition Select function to add flight conditions. (Up to five conditions can be used.)

Note: The T12K is designed so that the airplane and glider model types can utilize aircraft of the same wing type.

The functions common to airplanes and gliders, with the exception of some dedicated functions, are written without regard to the model type.

While there may be differences, depending on the number of servos, etc. the wing type used, etc. the setup screens in the instruction manual are typical examples.

- Call the model menu shown below by pushing and holding the MDL button at the home screen.

*The Model menu screen depends on the model type.

• Select the function name and return to the Model menu by pushing the RTN button or pushing the HOME/EXIT button.

<Push Dial>

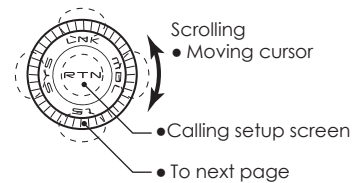

- Select the function you want to set and access the setup screen by pushing the RTN button.

Model Menu functions list

PITCH CURVE

Compatible with VPP (Variable Pitch Propeller) function. [Airplane, general]

THR CURVE

THR curve function adjusts the throttle operation curve for optimum engine speed to throttle stick movement. [Airplane/glider/multirotor, general]

THR DELAY

THR-DELAY function is used to slow the response of the throttle stick to simulate the slow response of a turbine engine, etc. [Airplane, general]

AIL DIFFERENTIAL

The left and right aileron differential can be adjusted independently. For gliders, the differential

rate in butterfly mixing can be adjusted.

[Airplane/glider, 2 ailerons or more]

FLAP SETTING

The up/down travel of each flap can be adjusted independently for each servo according to the wing type. [Airplane/glider, 2 flaps or more]

AIL to CMB.FLP

This mix operates the camber flaps in the aileron mode. It improves the roll axis characteristics. [Airplane/glider, 2 ailerons + 2 flaps or more]

AIL to BRKFLP

This mix operates the brake flaps in the aileron mode. It improves the roll axis characteristics. [Glider, 4 flaps]

AIL to RUD

This mix is used when you want to coordinate the rudder with aileron operation for banking at shallow angles. [Airplane/glider, general]

RUD to AIL

This function is used when you want to mix the ailerons with rudder input. Rudder is applied during rolling maneuvers such as knife edge flight. [Airplane/glider, general]

CAMBER MIX

This mix adjusts the camber and corrects the elevators. [Airplane/glider, 2 ailerons or more]

ELE to CAMBER

This mix is used when you want to mix camber flaps with elevator to increase the lift of the model. [Airplane/glider, 2 ailerons or more]

CAMB.FLP to ELE

This mix is used to correct for changes in attitude when the camber flaps are utilized. [Airplane/glider, 2 ailerons + 1 flap or more]

BUTTERFLY (Crow)

This function is used to quickly slow the aircraft and/or reduce the altitude. [Glider, 2 ailerons or more (Flying: 2 ailerons + 1 flap or more)]

TRIM MIX

The ailerons, elevators, and flaps trim offset rate can be accessed by selecting a switch or condition selection as desired. [Glider, 2 ailerons or more]

AIRBRAKE

This function is used when airbrakes are

necessary when landing or when diving, etc. during flight. [Airplane, 2 ailerons or more]

GYRO

This is a dedicated mix when a GYA Series gyro is used. [Airplane/glider/multirotor, general]

V-TAIL

This function incorporates the elevators and rudder input for use with V-tail models. [Airplane/glider, V-tail specifications]

AILEVATOR (DUAL ELEVATOR)

This function adjusts the elevators and ailerons of models with elevator specifications. [Airplane/glider, ailevator specifications]

WINGLET

This function adjusts the left and right rudders of winglet models. [Airplane/glider, winglet specifications]

MOTOR

This function adjusts the operation speed when the motor of an F5B or other such EP glider is started by a switch. [Airplane/glider, general]

RUD to ELE

This function is used to correct rolling maneuvers, such as knife edge flight. [Airplane, general]

SNAP ROLL

This function selects the snap roll switch and adjusts the amount of servo input. Servo speed can also be adjusted. [Airplane general]

FLIGHT MODE

This function selects 5 flight modes. [Multirotor]

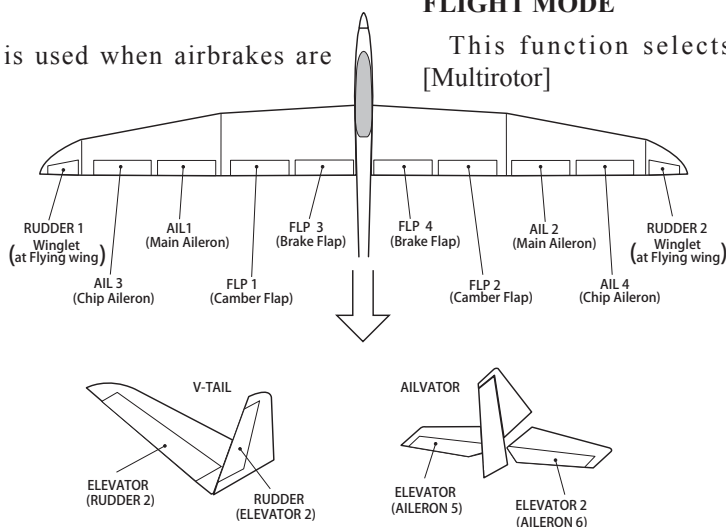

PIT CURVE

[Corresponding model type]: Airplane, general

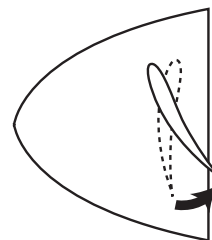

This function adjusts the pitch curve for VPP (Variable Pitch Propeller) airplanes.

- *Up to 3 conditions can be set.
- *The priority increases in condition 1→2→3 order.

- Select [PIT CURVE] at the Model menu and access the setup screen shown below by pushing the RTN button.

NOTE: When VPP is not assigned to any channel, the pitch curve is not displayed in the model menu. In this case, assign VPP to any channel on the function screen.

• Select the function name and return to the Model menu by pushing the RTN button or pushing the HOME/EXIT button.

• Curve rate • Curve point

<Push Dial>

- Scrolling
- Moving cursor
- Selecting mode
- Adjusting value
- To input data mode
- Data is entered

Setting method

•VPP condition selection

1. Move the cursor to the # button at the top right side of the screen and push the RTN button to switch to the data input mode.

Select the VPP condition by scrolling the Push dial.

*The display blinks.

Push the RTN button to call the setting screen and return to the cursor mode.

2. Move the cursor to the switch item and push the RTN button to access the selection screen. Select the switch and set its ON direction.

*For a description of the switch selection method, see the description at the back of this manual.

Set the VPP condition 2 and 3 switch.

*The VPP conditions can also be checked in the HOME screen.

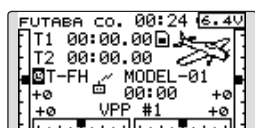

•5-point curve setting

[Curve rate setting]

1. Move the cursor to the curve rate setting item you want to adjust and push the RTN

button to switch to the data input mode.

Adjust the rate by scrolling the Push dial.

Initial value: 0%

Adjustment range: 0%~100%

*When the RTN button is pushed for one second, the rate is reset to the initial value.

Push the RTN button to end the adjustment and return to the cursor mode.

2. Repeat this procedure for each point. [Moving curve point]

1. Move the cursor to the curve point setting item you want to adjust and push the RTN button to switch to the data input mode.

Adjust the curve point by scrolling the Push dial.

Initial value: P1: (0%), P2: 25%, P3: 50%, P4: 75%, P5: (100%)

Adjustment range: Up to 2.5% in front of the adjoining point

*When the RTN button is pushed for one second, the curve position is reset to the initial value.)

Push the RTN button to end the adjustment and return to the cursor mode.

2. Repeat this procedure for each point.

[Deleting/returning curve point]

Move the cursor to the curve point setting item you want to delete/return and push the RTN button for one second.

This function adjusts the throttle curve for optimum engine speed from throttle stick input.

*When throttle curve is set to ON when there is no throttle function; this curve acts as the motor function.

- Select [THR CURVE] at the Model menu and access the setup screen shown below by pushing the RTN button.

NOTE: If this throttle curve function is activated, you cannot use the THR-EXP function within the DUAL RATE function simultaneously.

- Select the function name and return to the Model menu by pushing the RTN button or pushing the HOME/EXIT button.



THR CURVE **ACT INH**

```

>5 100.0 (100 )
>4  75.0  75.0
>3  50.0  50.0
>2  25.0  25.0
>1   0.0 (  0 )
            
```

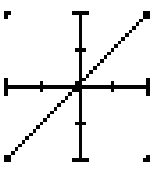

<Push Dial>

- Scrolling
- Moving cursor
- Selecting mode
- Adjusting value

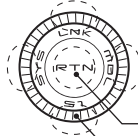

- To input data mode
- Data is entered
- To next page

- Curve rate
- Curve point

Setting method

• Activate the function.

1. Move the cursor to the [ACT] item and push the RTN button to switch to the data input mode.

Select the ON mode by scrolling the Push dial.

*The display blinks.

Push the RTN button to activate the function and return to the cursor mode.

• 5-point curve setting

[Curve rate setting]

1. Move the cursor to the curve rate setting item you want to adjust and push the RTN button to switch to the data input mode.

Adjust the rate by scrolling the Push dial.

Initial value: 0%

Adjustment range: 0%~100%

*When the RTN button is pushed for one second, the rate is reset to the initial value.)

Push the RTN button to end the adjustment and return to the cursor mode.

2. Repeat this procedure for each point.

[Moving curve point]

1. Move the cursor to the curve point setting

item you want to adjust and push the RTN button to switch to the data input mode.

Adjust the curve point by scrolling the Push dial.

Initial value: P1: (0%), P2: 25%, P3: 50%, P4: 75%, P5: (100%)

Adjustment range: Up to 2.5% in front of the adjoining point

*When the RTN button is pushed for one second, the curve position is reset to the initial value.)

Push the RTN button to end the adjustment and return to the cursor mode.

2. Repeat this procedure for each point.

[Deleting/returning curve point]

Move the cursor to the curve point setting item you want to delete/return and push the RTN button for one second.

THR-DELAY function is used to slow the response of the throttle stick to simulate the slow response of a turbine engine, etc.

*THR DELAY serves the same function as servo speed THR.

Use one or the other, not both. If both are used, the servo delay could be greater than intended.

- Select [THR DELAY] at the Model menu and access the setup screen shown below by pushing the RTN button.

- Select the function name and return to the Model menu by pushing the RTN button or pushing the HOME/EXIT button.

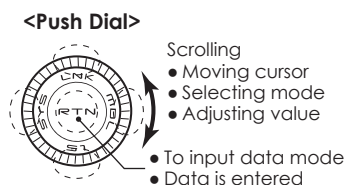

Setting method

•Operation speed (delay) setting

1. Move the cursor to the [DELAY] item and push the RTN button to switch to the data input mode.

Adjust the delay rate by scrolling the Push dial.

Initial value: 0

Adjustment range: 0~27 (maximum delay)

*When the RTN button is pushed for one second, the rate is reset to the initial value.)

Push the RTN button to activate the function and return to the cursor mode.

AIL DIFF.

[Corresponding model type]: Airplane/glider, 2 ailerons or more

The left and right aileron differential can be adjusted independently.

For gliders, the differential rate in butterfly mixing can be adjusted.

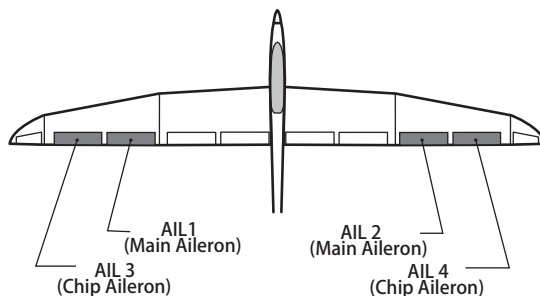

*The display screen is an example. The actual screen depends on the Model Type.

- Select [AIL DIFF.] at the Model menu and access the setup screen shown below by pushing the RTN button.

[Airplane (2A+2F)]

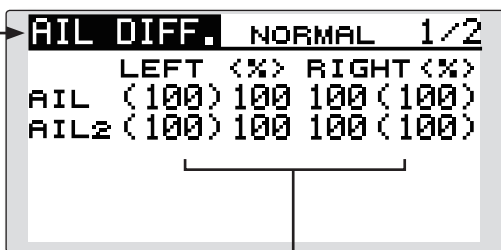

<Push Dial>

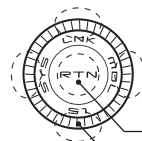

- Scrolling
- Moving cursor
 - Selecting mode
 - Adjusting value

- To input data mode
- Data is entered
- To next page

- Select the function name and return to the Model menu by pushing the RTN button or pushing the HOME/EXIT button.



- Aileron left/right adjustment

[Glider (4A+2F)]

(Currently selected condition name)

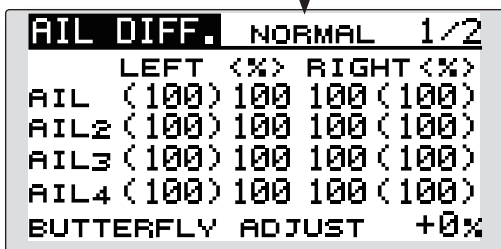

Setting method

•Aileron left/right adjustment

Move the cursor to the aileron (AIL) 1~4 left (or right) setting item and push the RTN button to switch to the data input mode.

Adjust the aileron angles by scrolling the Push dial when the stick is moved to the left (or right) end.

Initial value: 100%

Adjustment range: 0~120%

*When the RTN button is pushed for one second, the rate is reset to the initial value.)

Push the RTN button to end the adjustment and return to the cursor mode.

Example of Airplane (2AIL) P.1/2

```

AIL DIFF. NORMAL 1/2
LEFT <%> RIGHT <%>
AIL (100)100 100(100)
AIL2 (100)100 100(100)
    
```

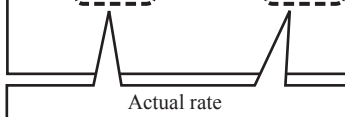

Example of Airplane (2AIL) P.2/2

```

AIL DIFF. NORMAL 2/2
FINE TUNING
[RO LIN. +20%]
    
```

It can be set by each condition.

Operation Mode
When the fine tune control is set, it is displayed.
Mode : LIN. / ATL+ / ATL- / SYM.

Fine tune control hardware

The fine tune rate range: -100 ~ +100%

Example of Glider (4AIL) P.1/2

```

AIL DIFF. NORMAL 1/2
LEFT <%> RIGHT <%>
AIL (100)100 100(100)
AIL2 (100)100 100(100)
AIL3 (100)100 100(100)
AIL4 (100)100 100(100)
BUTTERFLY ADJUST +0%
    
```

Example of Glider (4AIL) P.2/2

```

AIL DIFF. NORMAL 2/2
FINE TUNING
[RO LIN. +20%]
    
```

It can be set by each flight condition.

BUTTERFLY stick operation is 0.

```

AIL DIFF. NORMAL 1/2
LEFT <%> RIGHT <%>
AIL (100)100 100(100)
AIL2 (100)100 100(100)
AIL3 (100)100 100(100)
AIL4 (100)100 100(100)
BUTTERFLY ADJUST +0%
    
```

BUTTERFLY stick operation is 100%.

```

AIL DIFF. NORMAL 1/2
LEFT <%> RIGHT <%>
AIL ( 0)100 30(100)
AIL2 (100) 30(100) ( 0)
AIL3 ( 0)100 30(100)
AIL4 (100) 30 100( 0)
BUTTERFLY ADJUST +100%
    
```

The actual down rate = (Aileron Differential rate) + {(100-Aileron Differential rate) x (Butterfly Adjust rate)}

The actual up rate = (Aileron Differential rate) - (Aileron Differential Butterfly Adjust rate) x (Aileron Differential rate)

- *When BUTTERFLY ADJUSTMENT RATE is "+", Up rate is decreased and DOWN rate is increased.
- *When BUTTERFLY ADJUSTMENT RATE is "-", the calculation method of UP/DOWN and a direction become reversed.
- *When Flying wing 2AIL type, no BUTTERFLY ADJUSTMENT will be displayed. (There is no butterfly mixing.)
- *The start point of BUTTERFLY ADJUSTMENT shifted from the start point of BUTTERFLY MIXING. Then, it was corrected.

[Fine tuning VR operation mode]

- [LIN.] : Mixing rate 0% at center of VR. When the VR is turned clockwise and counterclockwise, the mixing rate increases and decreases, respectively.
- [ATL+] : Mixing rate 0% at left end of VR. When the VR is turned, the mixing rate increases.
- [ATL-] : Mixing rate 0% at right end of VR. When the VR is turned, the mixing rate increases.
- [SYM.] : When the VR is turned to the left or right of the neutral position, the mixing rate increases.

FLAP SET.

[Corresponding model type]: Airplane/glider, 2 flaps or more

The up/down travel of each flap (camber flaps: FLP1/2, brake flaps: FLP3/4) can be adjusted independently for each servo according to the wing type.

- The operation reference point of each flap can be offset

The camber flaps of a 4-flap model can be mixed with the brake flaps. (BRKFLP to CMBFLP)

- An ON/OFF switch can be set.
- Select [FLAP SET.] at the Model menu and access the setup screen shown below by pushing the RTN button.

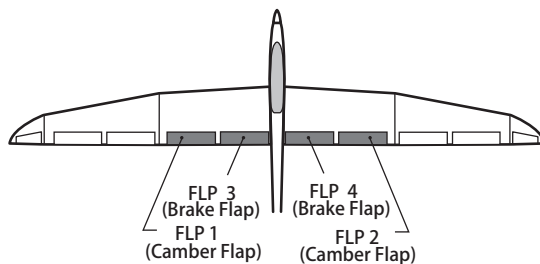

*The display screen is an example. The actual screen depends on the model type.

• Select the function name and return to the Model menu by pushing the RTN button or pushing the HOME/EXIT button.

• Up /Down adjustment • Operation reference point offset

<Push Dial>

- Scrolling
 - Moving cursor
 - Selecting mode
 - Adjusting value
- To input data mode
- Data is entered
- To next page

(Glider: Currently selected condition name)

Setting method

• Flap up/down adjustment

Move the cursor to the flap (FLP) 1~4 Up or Down item according to the wing type and push the RTN button to switch to the data input mode. Adjust the travel independently by scrolling the Push dial.

Initial value: +100%

Adjustment range: -120~+120%

*When the RTN button is pushed for one second, the rate is reset to the initial value.)

Push the RTN button to end the adjustment and return to the cursor mode.

• Reference point adjustment

Move the cursor to the [OFFSET] item and push the RTN button to switch to the data input mode. Adjust the operation reference point of each flap by scrolling the Push dial.

Initial value: 0%

Adjustment range: -100~+100%

*When the RTN button is pushed for one second, the reference point is reset to the initial value.)

Push the RTN button to end the adjustment and return to the cursor mode.

• Activate the Brake FLP to Camber FLP mixing

Move the cursor to the [ACT] item and push the RTN button to switch to the data input mode. Select the ACT mode by scrolling the Push dial.

*The display blinks.

Push the RTN button to activate the function and return to the cursor mode. (ON is displayed.)

To select a switch, move the cursor to the [SW] item and push the RTN button to call the selection screen. Select the switch and set its ON direction. (Always ON at "--" setting)

*For a description of the switch selection method, see the description at the back of this manual.

AIL to CMBFLP

[Corresponding model type]: Airplane/glider, 2 ailerons + 2 flaps or more

This mix operates the camber flaps (FLP1/2) in the aileron mode. When the aileron stick is manipulated, the ailerons and camber flaps perform aileron operation simultaneously to significantly improve the roll axis.

- The aileron left/right mixing rate of each flap servo can be independently adjusted.
- An ON/OFF switch can be set.
- Linking is possible: Link this mix to other mixes.

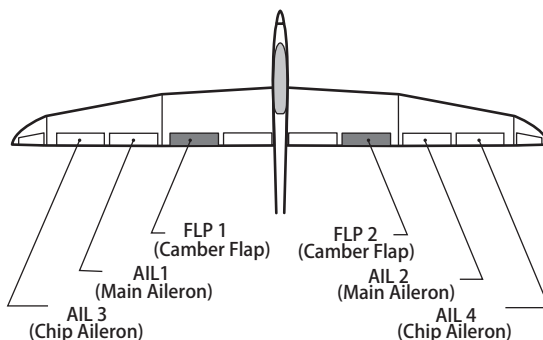

*The display screen is an example. The actual screen depends on the model type.

- Select [AIL to CMBFLP] at the Model menu and access the setup screen shown below by pushing the RTN button.

- Select the function name and return to the Model menu by pushing the RTN button or pushing the HOME/EXIT button.

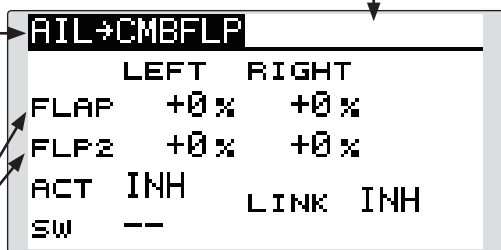

<Push Dial>

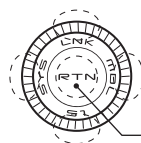

- Scrolling
- Moving cursor
- Selecting mode
- Adjusting value
- To input data mode
- Data is entered

- Adjustment of each flap servo

Setting method

•Activate the function

Move the cursor to the [ACT] item and push the RTN button to switch to the data input mode. Select the ACT mode by scrolling the Push dial.

*The display blinks.

Push the RTN button to activate the function and return to the cursor mode. (ON is displayed.)

When selecting a switch, move the cursor to the [SW] item and push the RTN button to call the selection screen. Select the switch and set its ON direction. (Always ON at "--" setting)

*For a description of the switch selection method, see the description at the back of this manual.

•Mixing rate adjustment

Move the cursor to the flap (FLP) 1~2 left or right item according to the wing type and push the RTN button to switch to the data input mode. Adjust the mixing rate independently by scrolling the Push dial.

Initial value: 0%

Adjustment range: -120~+120%

*When the RTN button is pushed for one second, the rate is reset to the initial value.)

Push the RTN button to end the adjustment and return to the cursor mode.

•Link mode setting

When linking a mix, move the cursor to the [LINK] item and push the RTN button to switch to the data input mode. Select the ON mode by scrolling the Push dial.

*The display blinks.

Push the RTN button to set the link mode and return to the cursor mode.

AIL to BRAKEFLP

[Corresponding model type]: Glider, 4 flaps

This mix operates the brake flaps (FLP3/4) in the aileron mode. When the aileron stick is manipulated, the aileron and brake flaps perform the aileron operation simultaneously and the roll axis is improved.

- The aileron left and right mixing rates can be adjusted separately for each flap servo.
- Mixing during flight can be turned ON/OFF by setting a switch. (Always ON at [-] setting)
- Linking can be set: Link this mix to other mixes.

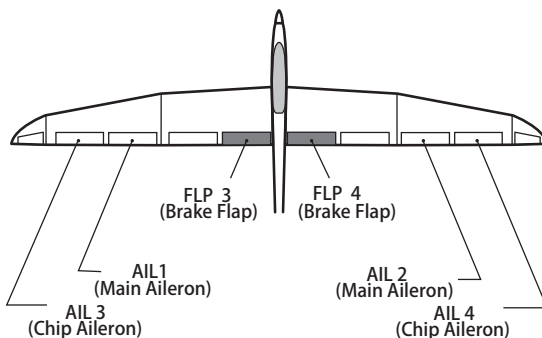

*The display screen is an example. The actual screen depends on the model type.

- Select [AIL to BRKFLP] at the Model menu and access the setup screen shown below by pushing the RTN button.

- Select the function name and return to the Model menu by pushing the RTN button or pushing the HOME/EXIT button.



(Currently selected condition name)

AIL→BRKFLP NORMAL			
	LEFT	RIGHT	
FLP3	+0%	+0%	
FLP4	+0%	+0%	
ACT	INH	LINK	INH
SW	--		

<Push Dial>

- Scrolling
- Moving cursor
- Selecting mode
- Adjusting value
- To input data mode
- Data is entered

- Adjustment of each flap servo

Setting method

•Activate the function

Move the cursor to the [ACT] item and push the RTN button to switch to the data input mode. Select the ACT mode by scrolling the Push dial.

*The display blinks.

Push the RTN button to activate the function and return to the cursor mode. (ON is displayed.)

When setting a switch, move the cursor to the [SW] item and push the RTN button to access the selection screen. Select the switch and set its ON direction. (Always ON at "--" setting)

*For a description of the switch selection method, see the description at the back of this manual.

•Mixing rate adjustment

Move the cursor to the flap (FLP) 3~4 left or right item and push the RTN button to switch to the data input mode. Adjust the mixing rate independently by scrolling the Push dial.

Initial value: 0%

Adjustment range: -120~+120%

*When the RTN button is pushed for one second, the rate is reset to the initial value.)

Push the RTN button to end the adjustment and return to the cursor mode.

•Link mode setting

To activate the mixing, move the cursor to the [LINK] item and push the RTN button to switch to the data input mode. Select the ON mode by scrolling the Push dial.

*The display blinks.

Push the RTN button to set the link mode and return to the cursor mode.

AIL to RUD

[Corresponding model type]: Airplane/glider, general

Use this mix when you want to mix the rudders with aileron operation. This allows the aircraft to bank at a steep angle.

- Mixing during flight can be turned ON/OFF by a switch. (Always ON at [-] setting)
- The mixing rate can be adjusted.

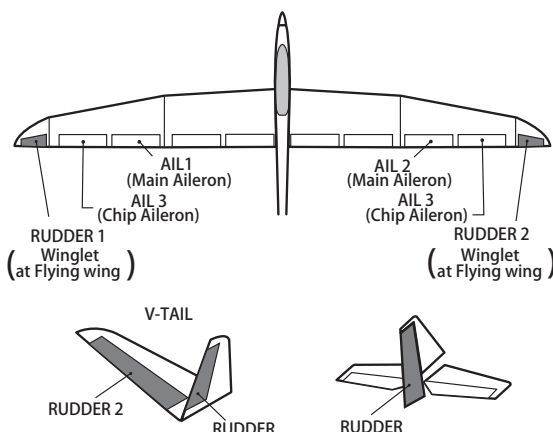

- Select [AIL to RUD] at the Model menu and access the setup screen shown below by pushing the RTN button.

- Select the function name and return to the Model menu by pushing the RTN button or pushing the HOME/EXIT button.

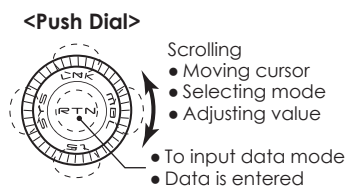
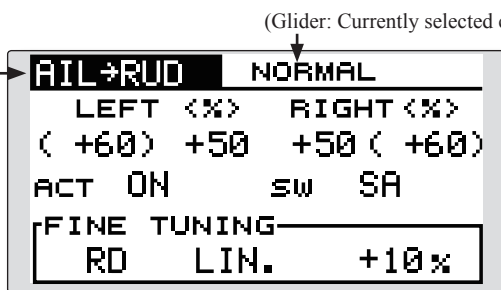

*The display screen is an example. The actual screen depends on the model type.

Setting method

•Activate the function

Move the cursor to the [ACT] item and push the RTN button to switch to the data input mode. Select the ACT mode by scrolling the Push dial.

*The display blinks.

Push the RTN button to activate the function and return to the cursor mode. (ON is displayed.)

When selecting a switch, move the cursor to the [SW] item and push the RTN button to call the selection screen. Select the switch and set its ON direction. (Always ON at "-" setting)

*For a description of the switch selection method, see the description at the back of this manual.

•Mixing rate adjustment

Move the cursor to the left or right item and push the RTN button to switch to the data input mode. Adjust the mixing rate independently by scrolling the Push dial.

Initial value: 0%

Adjustment range: -100~+100%

*When the RTN button is pushed for one second, the rate is

reset to the initial value.)

Push the RTN button to end the adjustment and return to the cursor mode.

•Fine tuning

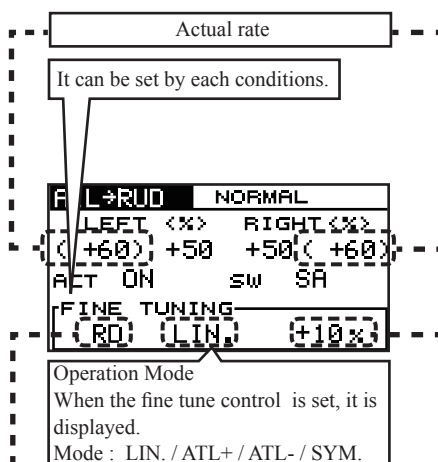

The fine tune control hardware

The fine tune rate Range : -100 ~ +100%

This function is used when you want to mix the ailerons with rudder input. It is used when rudder is applied during roll maneuvers, such as knife edge flight. It can be used to turn or bank scale models, large models, etc. like a full-size aircraft.

- Mixing during flight can be turned ON/OFF by setting a switch. (Always ON at [-] setting)
- Linking can be set: Link this mix to other mixes.
- The mixing rate can also be adjusted.
- A five-point curve can be set at airplane model type.

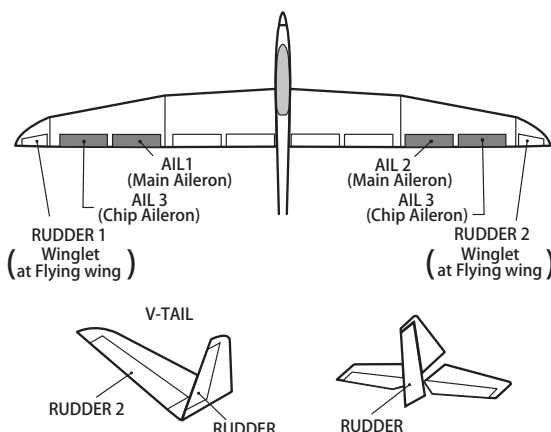

- Select [RUD to AIL] at the Model menu and access the setup screen shown below by pushing the RTN button.

- Select the function name and return to the Model menu by pushing the RTN button or pushing the HOME/EXIT button.

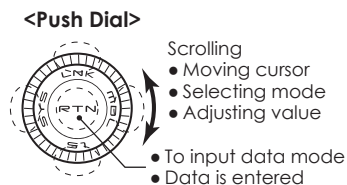
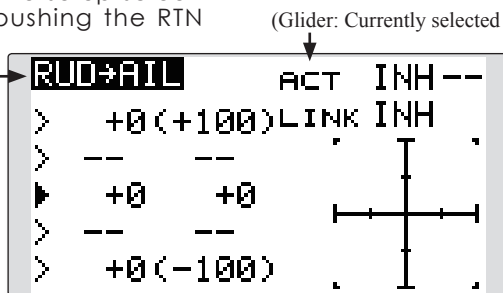

*The display screen is an example. The actual screen depends on the model type.

Setting method

•Activate the function

Move the cursor to the [ACT] item and push the RTN button to switch to the data input mode. Select the ACT mode by scrolling the Push dial.

*The display blinks.

Push the RTN button to activate the function and return to the cursor mode. (ON is displayed.)

When setting a switch, move the cursor to the [SW] item and push the RTN button to call the selection screen. Select the switch and set its ON direction. (Always ON at "--" setting)

*For a description of the switch selection method, see the description at the back of this manual.

•Mixing rate adjustment (glider)

Move the cursor to the left or right item and push the RTN button to switch to the data input mode. Adjust the mixing rate independently by scrolling the Push dial.

Initial value: 0%

Adjustment range: -100~+100%

*When the RTN button is pushed for one second, the rate is reset to the initial value.)

Push the RTN button to end the adjustment and return to the cursor mode.

•Link mode setting

To activate the link mixing, move the cursor to the [LINK] item and push the RTN button to switch to the data input mode. Select the ON mode by scrolling the Push dial.

*The display blinks.

Push the RTN button to set the link mode and return to the cursor mode.

●5-point curve setting (airplane)

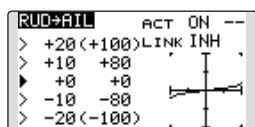

[Curve rate setting]

1. Move the cursor to the curve rate setting item (left side) you want to adjust and push the RTN button to switch to the data input mode.

Adjust the rate by scrolling the Push dial.

Adjustment range: -100%~+100%

*When the RTN button is pushed for one second, the rate is reset to the initial value.)

Push the RTN button to end the adjustment and return to the cursor mode.

2. Repeat this procedure for each point.

[Moving curve point]

1. Move the cursor to the curve point setting item you want to adjust and push the RTN button to switch to the data input mode.

Adjust the curve point by scrolling the Push dial.

Adjustment range: Up to 2.5% in front of the adjoining point

*When the RTN button is pushed for one second, the curve position is reset to the initial value.)

Push the RTN button to end the adjustment and return to the cursor mode.

2. Repeat this procedure for each point.

[Deleting/returning curve point]

Move the cursor to the curve point setting item you want to delete/return and push the RTN button for one second.

CAMBER MIX

[Corresponding model type]: Airplane/glider, 2 ailerons or more

This function adjusts the rate of camber operation for the wing camber (ailerons, camber flaps, brake flaps) in the negative and positive directions. The aileron, flap, and elevator rates can also be adjusted independently and attitude changes caused by camber operation can be corrected.

- *Initial setting assigns camber operation to side lever LS.
- The up/down rates of the aileron, flap, and elevator servos can be adjusted. When the mixing direction is reversed by the linkage, adjustments can be made by changing the mixing rate polarity (+ or -).
- Mixing during flight can be turned ON/OFF by setting a switch. (Always ON at [-] setting)
- A condition delay can be set. A cut switch which can turn OFF the delay function can be set.

- Select [CAMBER MIX] at the Model menu and access the setup screen shown below by pushing the RTN button.

*The display screen is an example. The actual screen depends on the model type.

- Select the function name and return to the Model menu by pushing the RTN button or pushing the HOME/EXIT button.



- Condition delay setting
- Condition delay cut switch

<Push Dial>

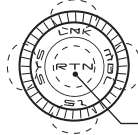

- Scrolling
- Moving cursor
- Selecting mode
- Adjusting value
- To input data mode
- Data is entered

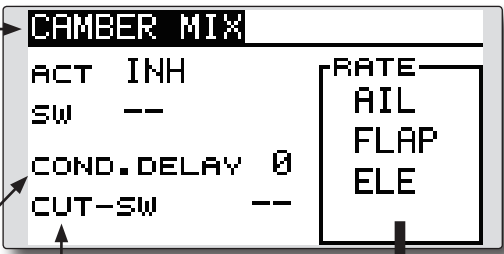

ACT INH
SW --
COND.DELAY 0
CUT-SW --

RATE
AIL
FLAP
ELE

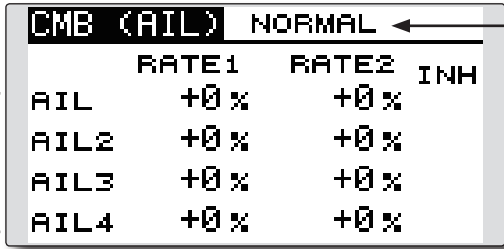

CMB (AIL) NORMAL

	RATE1	RATE2	INH
AIL	+0%	+0%	
AIL2	+0%	+0%	
AIL3	+0%	+0%	
AIL4	+0%	+0%	

(Glider: Currently selected condition name)

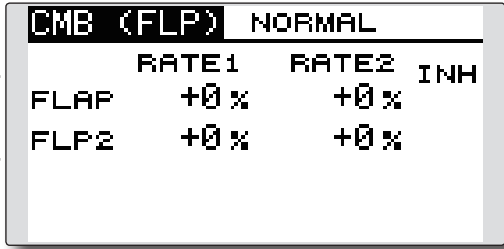

CMB (FLP) NORMAL

	RATE1	RATE2	INH
FLAP	+0%	+0%	
FLP2	+0%	+0%	

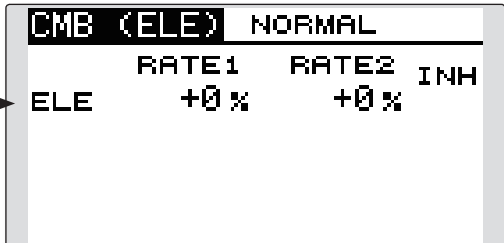

CMB (ELE) NORMAL

	RATE1	RATE2	INH
ELE	+0%	+0%	

Setting method

●Activate the function

Move the cursor to the [ACT] item and push the RTN button to switch to the data input mode. Select the ACT mode by scrolling the Push dial.

*The display blinks.

Push the RTN button to activate the function and return to the cursor mode. (ON is displayed.)

When setting a switch, move the cursor to the [SW] item and push the RTN button to call the selection screen. Select the switch and set its ON direction. (Always ON at "--" setting)

*For a description of the switch selection method, see the description at the back of this manual.

●Condition delay setting

Move the cursor to the [COND.DELAY] item and push the RTN button to switch to the data input mode. Adjust the condition delay by scrolling the Push dial.

Initial value: 0

Adjustment range: 0~27

*When the RTN button is pushed for one second, the rate is reset to the initial value.)

Push the RTN button to end the adjustment and return to the cursor mode.

When setting a cut switch, move the cursor to the [CUT-SW] item and push the RTN button to access the selection screen. Select the switch and set its ON direction. (Always ON at "--" setting)

*For a description of the switch selection method, see the description at the back of this manual.

●Rate adjustment

The rates are adjusted by accessing the aileron, flap, and elevator rate screens.

Move the cursor to the rate1 or rate2 item and push the RTN button to switch to the data input mode. Adjust the rate independently by scrolling the Push dial.

Initial value: 0%

Adjustment range: -100~+100%

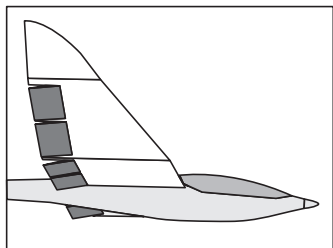

*When the RTN button is pushed for one second, the rate is reset to the initial value.)

Push the RTN button to end the adjustment and return to the cursor mode.

●3 Camber points

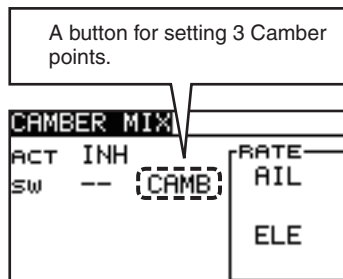

The screen at Airplane

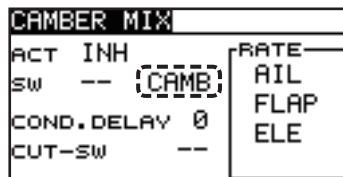

The screen at Glider

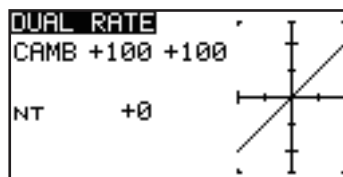

3 points setting of Camber function

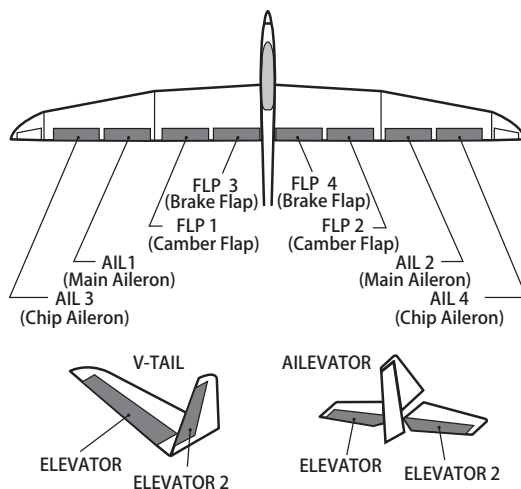

ELE to CAMBER

[Corresponding model type]: Airplane/glider, 2 ailerons or more

This function is used when you want to mix the camber flaps with elevator operation. When used, the flaps are lowered by up elevator, and lift is increased.

- Select [ELE to CAMBER] at the Model menu and access the setup screen shown below by pushing the RTN button.

- Select the function name and return to the Model menu by pushing the RTN button or pushing the HOME/EXIT button.

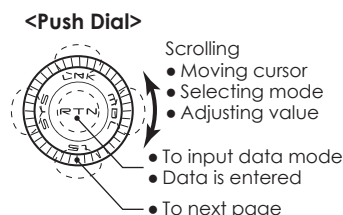
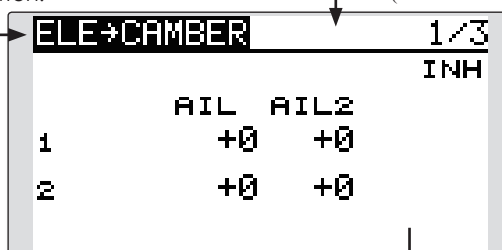

*The display screen is an example. The actual screen depends on the model type.

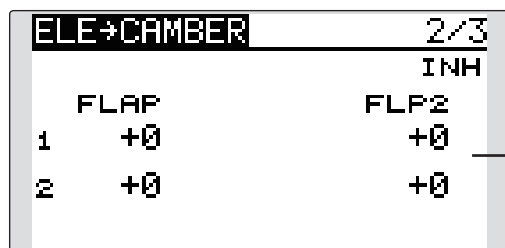

•Mixing rate adjustment

Move the cursor to the up or down mixing rate item for each servo and push the RTN button to switch to the data input mode. Adjust the rate independently by scrolling the Push dial.

Initial value: 0%

Adjustment range: -100~+100%

*When the RTN button is pushed for one second, the rate is reset to the initial value.)

Push the RTN button to end the adjustment and return to the cursor mode.

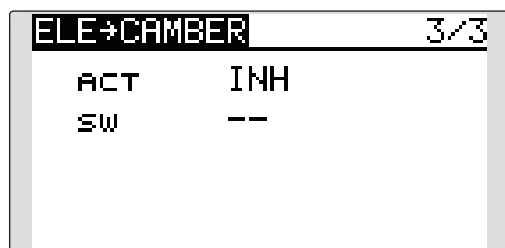

Setting method

•Activate the function

Move the cursor to the [ACT] item and push the RTN button to switch to the data input mode. Select the ACT mode by scrolling the Push dial.

*The display blinks.

Push the RTN button to activate the function and return to the cursor mode. (ON is displayed.)

When setting a switch, move the cursor to the [SW] item and push the RTN button to call the selection screen. Select the switch and set its ON direction. (Always ON at "--" setting)

*For a description of the switch selection method, see the description at the back of this manual.

•Range setting (Glider only)

Move the cursor to the [RANGE] item and hold the elevator stick to the desired position (upper or lower side) and then push the RTN button for one second to set the range.

*The mixing does not work near neutral of the elevator stick.

Initial value: 0%

Adjustment range: 0~100%

CMBFLP to ELE

[Corresponding model type]: Airplane/glider,
2 ailerons + 1 flap or more

When the camber/speed flaps are utilized, the aircraft might experience a change in pitch. This mix compensates for such changes by incorporating elevator input.

- The elevator servos' up/down rates can be adjusted separately. If the mixing direction is reversed, change the mixing rate polarity (+ or -).
- Mixing during flight can be turned ON/OFF by setting a switch. (Always ON at [-] setting)

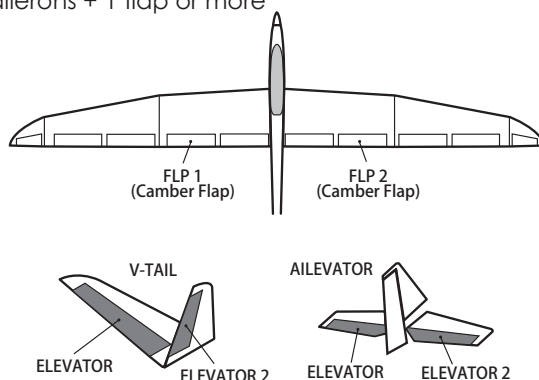

- Select [CMBFLP to ELE] at the Model menu and access the setup screen shown below by pushing the RTN button.

(Glider: Currently selected condition name)

• Select the function name and return to the Model menu by pushing the RTN button or pushing the HOME/EXIT button.

CMBFLP to ELE NORMAL

↓

RATE1 RATE2

ELE +0% +0%

ACT INH SW -- MODE A

<Push Dial>

• Elevator rate adjustment

*The display screen is an example. The actual screen depends on the model type.

Setting method

• Activate the function

Move the cursor to the [ACT] item and push the RTN button to switch to the data input mode. Select the ACT mode by scrolling the Push dial.

*The display blinks.

Push the RTN button to activate the function and return to the cursor mode. (ON is displayed.)

When setting a switch, move the cursor to the [SW] item and push the RTN button to call the selection screen. Select the switch and set its ON direction. (Always ON at "--" setting)

*For a description of the switch selection method, see the description at the back of this manual.

• Mixing rate adjustment

Move the cursor to the RATE1 or RATE2 item and push the RTN button to switch to the data input mode. Adjust the mixing rate independently by scrolling the Push dial.

Initial value: 0%

Adjustment range: -120~+120%

*When the RTN button is pushed for one second, the rate is reset to the initial value.)

Push the RTN button to end the adjustment and return to the cursor mode.

Camber FLP to ELE ModeA ModeB

3 points curve mixing similar to D/R is added to Camber FLP to ELE mixing function. It is an easy way to set the amount of moving ELE when FLP is down.

- ◆ **Mode A** ... Compatible to conventional 2 rates mixing.
- ◆ **Mode B** ... 3 Points curve mixing.

[Mode A] (Compatible to conventional 2 rates mixing.)

- The master of this mixing is output of Camber FLAP D/R.

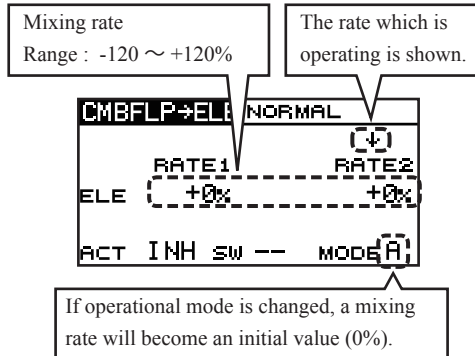

[Mode B] (3 Points curve mixing)

- The master of this mixing is the control hardware of Camber FLAP.

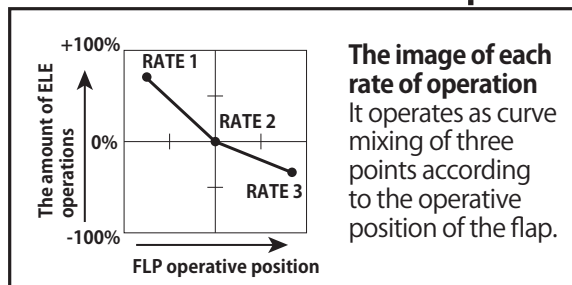
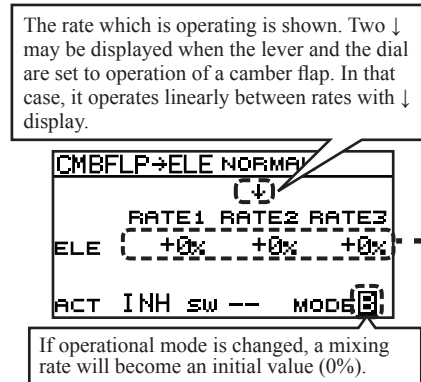

BUTTERFLY

[Corresponding model type]: Glider, Normal: 2 ailerons or more
Flying: 2 ailerons + 1 flap or more

This function is utilized to quickly slow the aircraft and reduce altitude by simultaneously raising the left and right ailerons and lowering the flaps (camber flap, brake flap).

Butterfly (Crow) produces an extremely efficient landing configuration by accomplishing the following:

1. Slow the aircraft's velocity.
2. Provide washout at the wing tips to reduce the tendency to tip stall.
 - Select [BUTTERFLY] at the Model menu and access the setup screen shown below by pushing the RTN button.

3. Create more lift toward the center of the wing, allowing it to fly at a slower speed

- Mixing during flight can be turned ON/OFF by setting a switch. (Always ON at [-] setting)
- The butterfly operation reference point can be offset.
- The operational speed of the ailerons and flaps can be adjusted.
- The differential rate can be adjusted.

*For a description of the setting method, see the aileron differential function.

*The display screen is an example. The actual screen depends on the model type.

• Select the function name and return to the Model menu by pushing the RTN button or pushing the HOME/EXIT button.

(Currently selected condition name)

<Push Dial>

- Scrolling
- Moving cursor
- Selecting mode
- Adjusting value
- To input data mode
- Data is entered
- To next page

- Aileron/flap rate adjustment

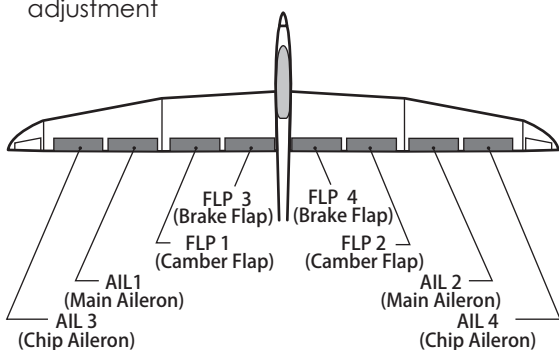

• Elevator adjustment

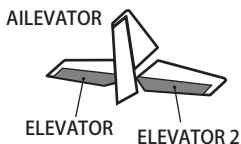
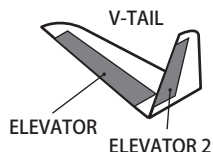

• Mode A (Normal)

The butterfly operation direction is reversed at the neutral position (50%) of the throttle stick.

• Mode B (Throttle stick full stroke MODE)

It does not reverse at the neutral position, so you can set the butterfly operation start point with the full stroke of the throttle stick.

• Butterfly operation reference point

• Servo speed setting

Setting method

●Activate the function

Move the cursor to the [ACT] item and push the RTN button to switch to the data input mode. Select the ACT mode by scrolling the Push dial.

*The display blinks.

Push the RTN button to activate the function and return to the cursor mode. (ON is displayed.)

When setting a switch, move the cursor to the [SW] item and push the RTN button to call the selection screen. Select the switch and set its ON direction. (Always ON at "--" setting)

*For a description of the switch selection method, see the description at the back of this manual.

●Rate adjustment

Move the cursor to the aileron, flap or elevator rate item and push the RTN button to switch to the data input mode. Adjust the rate independently by scrolling the Push dial.

Initial value: 0%

Adjustment range: -200~+200% (Elevator: -120~+120%)

*When the RTN button is pushed for one second, the rate is reset to the initial value.)

Push the RTN button to end the adjustment and return to the cursor mode.

●Elevator compensation curve adjustment

●Fine tune

The fine tune control hardware

```

BUTTERFLY NORMAL 3/3
ACT OFF MODE A SPEED
SW SC ELE AIL 0
RS LIN (+10%) FLAP 0
OFFSET 15% ELE 0
    
```

Operation Mode
When the fine tune control is set, it is displayed.
Mode: LIN. / ATL+ / ATL- / SYM.

The fine tune rate
Range: -100 ~ +100%

```

BUTTERFLY NORMAL 2/3
ELE +30 (<+25>)
ELE2 +30 (<+25>)
Y X (RS)
2 - - - - -
1 -100 ( 0)
    
```

Actual rate

Fine Tune Control

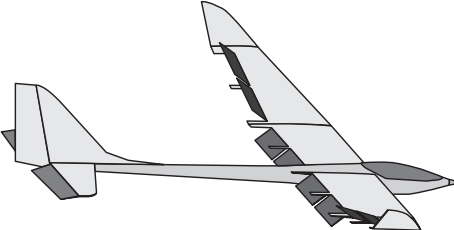

*When Flying wing type, it was made not to display BUTTERFLY ELE. (There is no elevator rate setting.)

	Output (Y)	Position (X)
Offset point	Fixed (0)	Fixed (offset position)
2- Intermediate point	Settable	Settable
1- End point	Settable	Fixed

* The range where mixing does not work close to the neutral position of the elevator stick can be adjusted. (Glider only)

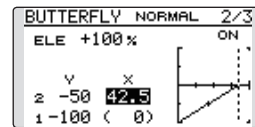
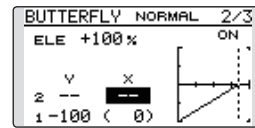

*When offset is set, the curve is initialized.

●Reference point adjustment

Move the cursor to the [OFFSET] item and hold the airbrake stick to the desired position. Then, push the RTN button for one second to set the butterfly operational reference point.

Initial value: 15% (upper side)

Adjustment range: 0~100%

●Servo speed setting

Move the cursor to the aileron, flap or elevator speed item and push the RTN button to switch to the data input mode.

Adjust the rate by scrolling the Push dial.

Initial value: 0

Adjustment range: 0~27 (maximum delay)

*When the RTN button is pushed for one second, the rate is reset to the initial value.)

Push the RTN button to activate the function and return to the cursor mode.

TRIM MIX

[Corresponding model type]: Glider, 2 ailerons or more

This function adjusts the trim offset rates of the ailerons, elevators, rudder and flaps (camber flaps, brake flaps) according to the flight status.

As an example this function can be set up for launching, with speed flaps and ailerons drooped, and a slight amount of up elevator. It can also be used for high speed flying, with both ailerons and speed flaps reflexed slightly, and a bit of down elevator.

To prevent sudden trim changes when switching flight conditions, a delay can be set to provide a

smooth transition between the two conditions. It is also possible to program a cut switch, which will turn off the delay.

Furthermore, you can set the auto switch, which will link the trim mix to a stick, switch, or dial.

Additionally, the speed of the aileron, elevator, rudder, and flap servos can be adjusted.

- Select [TRIM MIX] at the Model menu and access the setup screen shown below by pushing the RTN button.

*The display screen is an example. The actual screen depends on the model type.

• Select the function name and return to the Model menu by pushing the RTN button or pushing the HOME/EXIT button.

(Currently selected condition name)

TRIM MIX		NORMAL		1/2
AIL	AIL2	INH		
+0	+0			
FLAP		FLP2		
+0		+0		
ELE	+0	+0	RUD	

• Ailerons, flaps, elevators and rudder offset rate

<Push Dial>

- Scrolling
- Moving cursor
- Selecting mode
- Adjusting value
- To input data mode
- Data is entered
- To next page

• Switch selection

• Condition delay setting

TRIM MIX		NORMAL		2/2
ACT INH	--	SPEED		
		AIL	0	
COND.DELAY	0	FLAP	0	
CUT-SW	--	ELE	0	
AUTO-SW	--	RUD	0	

• Auto switch selection

• Ailerons, flaps, elevators and rudder servo speed setting

Setting method

●Activate the function

Move the cursor to the [ACT] item and push the RTN button to switch to the data input mode. Select the ACT mode by scrolling the Push dial.

*The display blinks.

Push the RTN button to activate the function and return to the cursor mode. (ON is displayed.)

When setting a switch, move the cursor to the switch item and push the RTN button to access the selection screen. Select the switch and set its ON direction. (Always ON at "--" setting)

*For a description of the switch selection method, see the description at the back of this manual.

●Trim offset rate adjustment

Move the cursor to the aileron, flap or elevator rate item and push the RTN button to switch to the data input mode. Adjust the rate independently by scrolling the Push dial.

Initial value: 0%

Adjustment range: -250~+250%

*When the RTN button is pushed for one second, the rate is reset to the initial value.)

Push the RTN button to end the adjustment and return to the cursor mode.

●Condition delay setting

Move the cursor to the [COND.DELAY] item and push the RTN button to switch to the data input mode. Adjust the condition delay by scrolling the Push dial.

Initial value: 0

Adjustment range: 0~27

*When the RTN button is pushed for one second, the servo operation position is reset to the initial value.)

Push the RTN button to end the adjustment and return to the cursor mode.

When setting a cut switch, move the cursor to the [CUT-SW] item and push the RTN button to access the selection screen. Select the switch and set its ON direction. (Always ON at "--" setting)

*For a description of the switch selection method, see the description at the back of this manual.

●Servo speed setting

Move the cursor to the aileron, flap or elevator speed item and push the RTN button to switch to the data input mode.

Adjust the rate by scrolling the Push dial.

Initial value: 0

Adjustment range: 0~27 (maximum delay)

*When the RTN button is pushed for one second, the rate is reset to the initial value.)

Push the RTN button to activate the function and return to the cursor mode.

●Auto switch selection

When selecting an auto switch, move the cursor to the [AUTO-SW] item and push the RTN button to access the selection screen. Select the switch and set its ON direction. (Always ON at "--" setting)

*For a description of the switch selection method, see the description at the back of this manual.

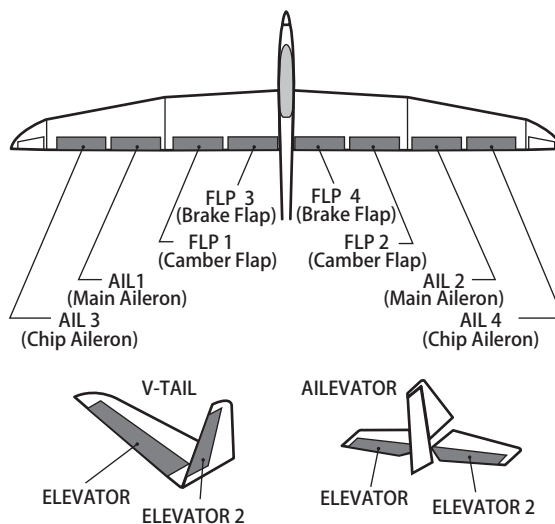

AIRBRAKE

[Corresponding model type]: Airplane, 2 ailerons or more

This function is used to increase the aircraft's drag and is useful for landing or diving, etc.

The preset ailerons, elevators, rudder and flaps (camber flap, brake flap) offset amount can be activated by a switch.

The offset amount of the aileron, elevator, rudder and flap servos can be adjusted as needed. Also, the speed of the aileron, elevator, rudder and flap servos can be adjusted. If the Auto Mode is activated, this will link the Airbrake to a stick, switch, or dial. A separate stick switch or dial can also be set as the ON/OFF switch.

Setting example for F3A and other flaperon specifications

(When 2 ailerons model type selected)

Offset rate:

AIL: [-35~-45%], AIL2: [-35~-45%], ELE: [+5~7%]

Note: The input numerics are examples. Adjust the travel to match the aircraft.

Mode setting:

ACT: [ON]

Switch: [SW-C]

AUTO-SW: [-]

- Select [AIRBRAKE] at the Model menu and access the setup screen shown below by pushing the RTN button.

*The display screen is an example. The actual screen depends on the model type.

- Select the function name and return to the Model menu by pushing the RTN button or pushing the HOME/EXIT button.

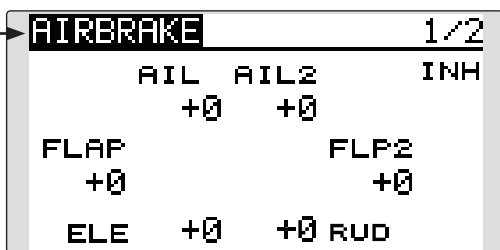

- Ailerons, flaps, rudder and elevators offset rate

<Push Dial>

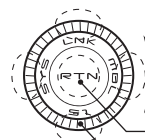

Scrolling

- Moving cursor
- Selecting mode
- Adjusting value

- To input data mode
- Data is entered
- To next page

- Switch selection

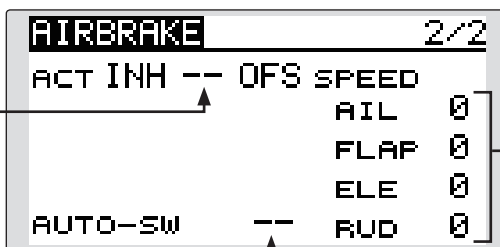

- Ailerons, flaps, rudder and elevators servo speed setting

- Auto switch selection

Setting method

●Activate the function

Move the cursor to the [ACT] item and push the RTN button to switch to the data input mode. Select the ACT mode by scrolling the Push dial.

*The display blinks.

Push the RTN button to activate the function and return to the cursor mode. (ON is displayed.)

When setting a switch, move the cursor to the switch item and push the RTN button to access the selection screen. Select the switch and set its ON direction. (Always ON at "--" setting)

*For a description of the switch selection method, see the description at the back of this manual.

●Offset rate adjustment

Move the cursor to the aileron, flap, rudder or elevator rate item and push the RTN button to switch to the data input mode. Adjust the rate independently by scrolling the Push dial.

Initial value: 0%

Adjustment range: -250~+250%

*When the RTN button is pushed for one second, the rate is reset to the initial value.)

Push the RTN button to end the adjustment and return to the cursor mode.

●Servo speed setting

Move the cursor to the aileron, flap, rudder or elevator speed item and push the RTN button to switch to the data input mode.

Adjust the rate by scrolling the Push dial.

Initial value: 0

Adjustment range: 0~27 (maximum delay)

*When the RTN button is pushed for one second, the rate is reset to the initial value.)

Push the RTN button to return to the cursor mode.

●Auto switch selection

When setting a auto switch, move the cursor to the [AUTO-SW] item and push the RTN button to access the selection screen. Select the switch and set its ON direction. (Always ON at "--" setting)

*For a description of the switch selection method, see the description at the back of this manual.

●Linear mode

In Linear Mode, Airbrake is operated by the stick or lever.

The start point of the mixing can be set.

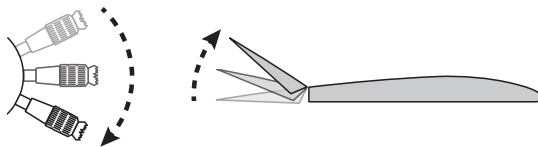

Operated by the stick or lever

Air brake moves in linear

Mode button
OFS : Offset mode
LIN : Linear mode

AIRBRAKE		2/2
ACT INH --	(OFS)	SPEED
		AIL 0
		FLAP 0
		ELE 0
AUTO-SW --		RUD 0

The screen of Offset mode

The start point this mixer is set.
< > is current position of MASTER.
At J1, J4, LD and RD, the left end point is 0%, the right end point is 100%.
At J2, J3, LS, RS and SA-SH, the upper end point is 100%, the lower end point is 0%

AIRBRAKE		2/2
ACT INH --	(LIN)	SPEED
(POS 0% < 0% >)		AIL 0
		FLAP 0
		ELE 0
(MASTER J3)		RUD 0

The operation hardware is set.
The default setting is below;
Stick Mode 1 : J2
Stick Mode 2 : J3

e.g. Start point

J3: < 50% >

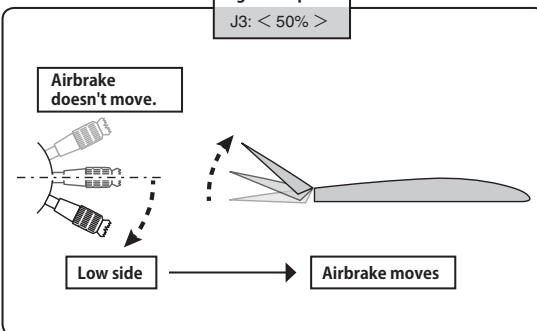

Airbrake doesn't move.

Low side

Airbrake moves

GYRO

[Corresponding model type]: Airplane/glider/Multirotor, general

This function is used when a GYA Series gyro is used to stabilize the aircraft's attitude. The sensitivity and operation mode (Normal mode/AVCS mode) can be changed via a switch.

- Three rates (Rate1/Rate2/Rate3) can be switched.
- Up to 3 axes (Gyro/Gyro2/Gyro3) can be simultaneously controlled.

Note: This setting does not assign a sensitivity channel. To do so, use the Linkage menu prior to assigning the sensitivity channel (Gyro/Gyro2/Gyro3). Be sure to select an unused channel.

Set the [Control] and [Trim] settings other than Function to [--].

- Select [GYRO] at the Model menu and access the setup screen shown below by pushing the RTN button.

[Rate 1 setup screen]

GYRO		ACTIVE#1	
# 1		%	%
GYRO	AVCS	80 <	70 > RD
GYRO2	AVCS	80 <	96 > LD
GYRO3	AVCS	80 <	75 > LS
TYPE	GY	ON	SC

[Rate 2 setup screen]

GYRO		ACTIVE#2	
# 2		%	%
GYRO	AVCS	80 <	70 > RD
GYRO2	AVCS	80 <	96 > LD
GYRO3	AVCS	80 <	75 > LS
TYPE	GY	ON	SC

[Rate 3 setup screen]

GYRO		ACTIVE#3	
# 3		%	%
GYRO	AVCS	80 <	70 > RD
GYRO2	AVCS	80 <	96 > LD
GYRO3	AVCS	80 <	75 > LS
TYPE	GY	ON	SC

(Active rate # display)

<Push Dial>

- Scrolling
- Moving cursor
- Selecting mode
- Adjusting value
- To input data mode
- Data is entered

• The operation mode (AVCS/NOR) and sensitivity of the three axis Gyro/Gyro2/Gyro3 can be set.

• The fine tuning hardware setting
Setting range :
GY type : Setting rate $\pm 20\%$ (The actual rate has not to be greater than 100%.)
NORM type : Setting rate $\pm 10.0\%$ (The actual rate has not to be greater than 100%.)

- Select the function name and return to the Model menu by pushing the RTN button or pushing the HOME/EXIT button.
- Rate1-3 setup screen selection
- Gyro type selection
- ACT/INH
- Switch selection

Setting method

*Prior to using the Function menu in the Linkage menu to assign the sensitivity channel (Gyro/Gyro2/Gyro3), select an unused channel.

Set [Control] and [Trim] other than function to [--].

•Rate 1-3 setup screen selection

Move the cursor to the setup screen selection item and push the RTN button to switch to the data input mode. Select the setup screen # by scrolling the Push dial.

Push the RTN button to change the setup screen and return to the cursor mode.

•Activate the function

Move the cursor to the [INH] item and push the RTN button to switch to the data input mode. Select the ACT mode by scrolling the Push dial.

*The display blinks.

Push the RTN button to activate the function and return to the cursor mode.

When setting a rate selection switch, move the cursor to the switch item and push the RTN button to access the selection screen. Select the switch and set its ON direction. (Always ON at "--" setting)

*For a description of the switch selection method, see the description at the back of this manual.

●Gyro type selection

Move the cursor to the gyro type selection item and push the RTN button to switch to the data input mode. Select the gyro type by scrolling the Push dial.

[GY]: When a Futaba GYA gyro is used

[NORM]: When using something other than Futaba GYA gyro is used.

Push the RTN button to change the gyro type and return to the cursor mode.

*When a Futaba GYA gyro is used and [GY] type is selected, the sensitivity set value is directly read in both AVCS and NORM modes.

selection item and push the RTN button to switch to the data input mode. Select the operation mode by scrolling the Push dial.

[AVCS]: AVCS mode

[NORM]: Normal mode

Push the RTN button to change the operation mode and return to the cursor mode.

●Sensitivity setting

Move the cursor to the sensitivity icon and push the RTN button to switch to the data input mode.

Adjust the sensitivity by scrolling the Push dial.

Initial value: 0%

Adjustment range: 0~100%

*When the RTN button is pushed for one second, the sensitivity is reset to the initial value.)

Push the RTN button to return to the cursor mode.

●Operation mode selection (GYA gyro)

Move the cursor to the operation mode

(Example) Setting three axis using a GYA440 and GYA441 (2)

- Wing type: 2 fuselage-mounted aileron servos selected.
- Set **5CH → GYRO** (GYA441AIL), **7CH → GYRO2** (GYA441ELE), **8CH → GYRO3** (GYA440RUD), **CTRL and TRIM → [--]** : at the Function menu of the Linkage menu.
- GYRO setting of the Model menu.

Rate	GYRO	GYRO 2	GYRO 3	TYPE	ACT/INH	SW
#1	AVCS : 60%	AVCS : 60%	AVCS : 60%	GY	OFF/ON	SE
#2					INH	
#3	NORM : 60%	NORM : 60%	NORM : 60%	GY	ON/OFF	SE

*Set so that Rate 1 is turned on at the back position of switch E and Rate 3 is turned ON at the front position. Since switch E is turned OFF at the center, Rate 2 remains [INH].

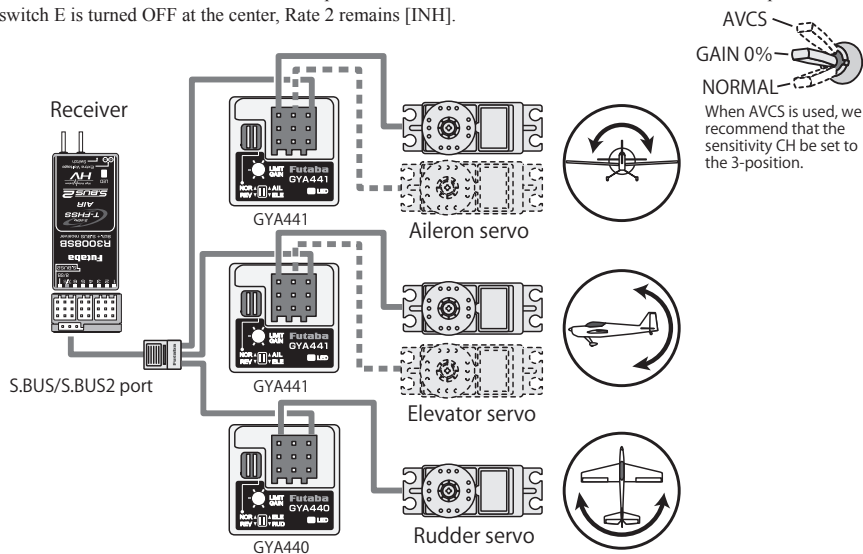

V-TAIL

[Corresponding model type]: Airplane/glider, V-tail

This function enables adjustments for left and right rudder angle changes during elevator and rudder operation of a V-tail airplane.

V-tail is when two servos are used together to control rudder movement as elevators. In addition to each elevator side moving up and down together, each side moves in opposite directions when moving as rudders. On a V-tail, this is also known as a Ruddervator, as they serve the same purpose.

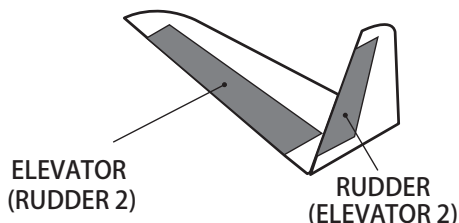

- Select [V-TAIL] at the Model menu and access the setup screen shown below by pushing the RTN button.

• Select the function name and return to the Model menu by pushing the RTN button or pushing the HOME/EXIT button.

W-TAIL			
ELEVATOR			
ELE <RUD2>	↑	↓	
RUD <ELE2>	+50 %	+50 %	
RUDDER			
ELE <RUD2>	←	→	
RUD <ELE2>	+50 %	+50 %	

(Elevator function)
Up and down travel adjustment of elevator operation

(Rudder function)
Left and right travel adjustment of rudder operation

<Push Dial>

- Scrolling
- Moving cursor
- Selecting mode
- Adjusting value
- To input data mode
- Data is entered

Setting method

• Travel adjustment

Move the cursor to the item you want to adjust and push the RTN button to switch to the data input mode.

Adjust the rate by scrolling the Push dial.

Initial value: +50%

Adjustment range: -120~+120%

*When the RTN button is pushed for one second, the rate is reset to the initial value.)

Push the RTN button to return to the cursor mode.

*If the mixing direction is reversed, adjustments can be made by changing the mixing rate polarity (+ or -).

*If a large value of travel is specified, when the sticks are moved at the same time, the controls may bind or run out of travel. Decrease the travel until no binding occurs.

AILEVATOR

[Corresponding model type]: Airplane/glider, Ailevator
(Effective only when 2 servos used at the elevators)

This function improves the performance of the roll axis by operating the elevators as ailerons.

Ailevator is where each elevator in a standard (conventional) or v-tail moves independently, like ailerons on a wing. In addition to each elevator side moving up and down together, each side moves in opposite directions when moving as an Ailevator. On a V-tail, this is also known as a Ruddervator, as they can serve the same purpose. Typically, both Ailevator and ailerons are coupled together to maximize roll performance, especially on larger wingspan planes.

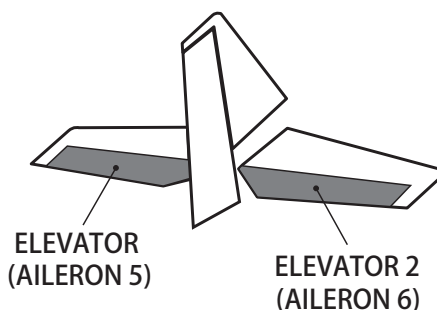

Note: Select Ailevator as the Model Type at the Model Type screen. This changes the output channel. Check the Function menu.

- Select [AILEVATOR] at the Model menu and access the setup screen shown below by pushing the RTN button.

- Select the function name and return to the Model menu by pushing the RTN button or pushing the HOME/EXIT button.

```

AILEVATOR
ELEVATOR      ↑      ↓
ELE <AILS> +100% +100%
ELE2<AILS> +100% +100%
AILERON       ←      →
ELE <AILS>   +0%   +0%
ELE2<AILS>   +0%   +0%
            
```

<Push Dial>

- Scrolling
- Moving cursor
- Selecting mode
- Adjusting value
- To input data mode
- Data is entered

(Elevator function)

(Aileron function)

- The up and down rate of both elevators when the elevator stick is moved can be individually adjusted.

- When the elevators are used as ailerons, aileron travel of the left and right elevators can be adjusted.

Setting method

• Travel adjustment

Move the cursor to the item you want to adjust and push the RTN button to switch to the data input mode.

Adjust the rate by scrolling the Push dial.

Initial value: ELE: +100%, AIL: 0%

Adjustment range: -120~+120%

*When the RTN button is pushed for one second, the rate is reset to the initial value.)

Push the RTN button to return to the cursor mode.

*If the mixing direction is reversed, adjustments can be made by changing the mixing rate polarity (+ or -).

*If a large value of travel is specified, when the sticks are moved at the same time, the controls may bind or run out of travel. Decrease the travel until no binding occurs.

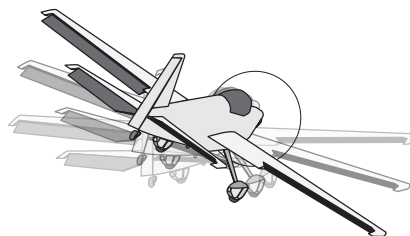

WINGLET

[Corresponding model type]: Airplane/glider, Flying wing only

This function adjusts the left and right rudder angles of airplanes with winglets.

Winglets are used to improve the efficiency of aircraft by lowering the lift-induced drag caused by wingtip vortices. The winglet is a vertical or angled extension located at the tip of each wing.

Winglets work by increasing the wing's effective aspect ratio without adding to the structural stress and weight of its structure. An extension of wingspan would also permit lowering of induced drag, though it requires boosting the wing's strength and weight. A winglet helps solve this by effectively increasing the aspect ratio without adding to the wingspan.

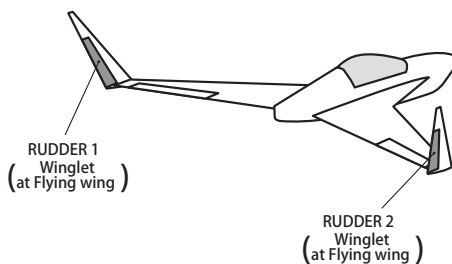

- Select [WINGLET] at the Model menu and access the setup screen shown below by pushing the RTN button.

- Select the function name and return to the Model menu by pushing the RTN button or pushing the HOME/EXIT button.

WINGLET

RUDDER	←		→	
RUDDER		+100%		+100%
RUDDER2		+100%		+100%

<Push Dial>

- Scrolling
- Moving cursor
- Selecting mode
- Adjusting value
- To input data mode
- Data is entered

(Rudder 1/2)

Setting method

• Travel adjustment

Move the cursor to the item you want to adjust and push the RTN button to switch to the data input mode.

Adjust the rate by scrolling the Push dial.

Initial value: +100%

Adjustment range: -120~+120%

*When the RTN button is pushed for one second, the rate is reset to the initial value.)

Push the RTN button to return to the cursor mode.

*If the mixing direction is reversed, change the mixing rate polarity (+ or -).

- The travel during rudder stick operation can be individually adjusted.

MOTOR

[Corresponding model type]: Airplane/glider, general

This function lets you set the speed when the motor of an F5B or other EP glider is started via a switch. The operation speed can be set for two ranges, slow speed flight and high speed flight (Speed1/Speed2). This function can also be operated as a safety function by programming it to a switch.

- The In side and Out side operating speeds can be adjusted independently in 2 ranges (Speed1/Speed2).
- The boundary between the 2 ranges can be set. (From Speed1 to Speed2)
- The operational speed can only be activated at the initial operation. However, operation can be repeated by setting the switch to OFF before the operation is finished. When you want to reset, one

time operation, set the ACT/INH item to [INH] and then reset it to [ON].

- The motor channel is controlled by SW-G. (Glider: Initial setting) When changing the switch or stick which controls the motor, first change Function of the Linkage menu.
- If the Model Type selected is Airplane, the MOTOR function is changed from INH to ON and it is not assigned to another channel. The changes from the throttle channel to the motor channel are enabled.

Note: Initial setting does not assign a motor channel according to the model type. Prior to assigning the motor channel, find an unused channel. Then, use the Function menu of the Linkage menu.

Set [Control] to the switch you want to use and [Trim] to [--].

Note: When using this function, always check the initial operation with the propeller removed.

- Select [MOTOR] at the Model menu and access the setup screen shown below by pushing the RTN button.

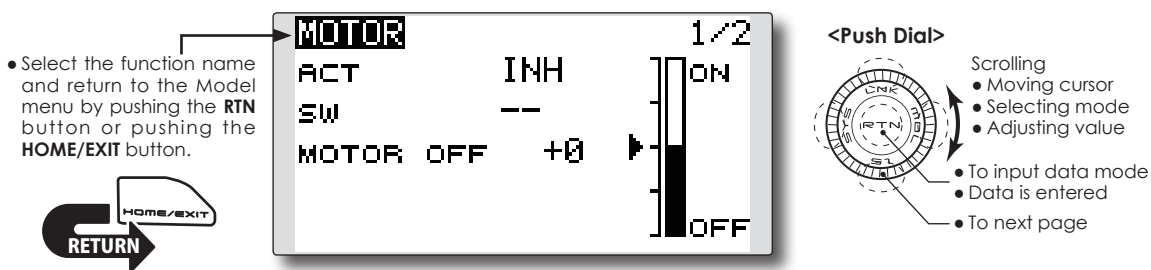

Setting method

• Activate the function

When using this function, move the cursor to the [ACT/INH] item and push the RTN button to switch to the data input mode. Select the [ACT] by scrolling the Push dial and push the RTN button.

When selecting the ON/OFF switch, move the cursor to the switch item and push the RTN button to access the selection screen. Select the switch and set its ON direction. (Always ON at "--" setting)

*For a description of the switch selection method, see the description at the back of this manual.

• Motor off position setting

Move the cursor to the [MOTOR OFF] item and push the RTN button for one second when the motor function switch (SG, etc.) is in the MOTOR OFF position you want to set. The direction of the motor switch is memorized.

The screen graph display OFF direction also changes.

Note:

- **First decide the motor OFF direction, and then set the speed. When you want to reset the motor OFF direction, also reset the speed.**
- **We recommend that Motor OFF be set in combination with F/S.**
- **Set the basic operation direction with the Reverse function to match the ESC used.**
- **Always set the Motor OFF position.**

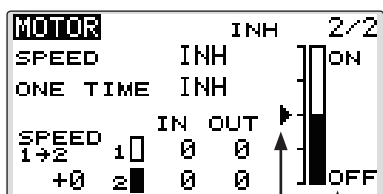

- ON/OFF direction
- Motor function switch current position

Setting method

• Activate the motor speed function

When using motor speed function, move the cursor to the [INH] item and push the RTN button to switch to the data input mode. Select the [ACT] by scrolling the Push dial and push the RTN button.

• Sifting the boundary between the 2 ranges

Move the cursor to the [SPEED1>2] item and push the RTN button to switch to the data input mode.

Adjust the boundary position by scrolling the Push dial.

Initial value: 0%

Adjustment range: -100~+100%

*When the RTN button is pushed for one second, the rate is reset to the initial value.)

Push the RTN button to return to the cursor mode.

• Operation speed adjustment

Move the cursor to the [IN] (on to off) or [OUT] (off to on) item and push the RTN button to switch to the data input mode.

Adjust the operation speed you want to set by scrolling the Push dial.

Initial value: 0

Adjustment range: 0~27

*When the RTN button is pushed for one second, the rate is reset to the initial value.)

Push the RTN button to return to the cursor mode.

• Set/Reset the one time operation

Move the cursor to the [ONE TIME] item and push the RTN button to switch to the data input mode.

Select the [ACT] by scrolling the Push dial and push the RTN button to set the ONE TIME operation.

*When you want to reset ONE TIME operation, set the ACT/INH item to [INH] and then reset it to [ON].

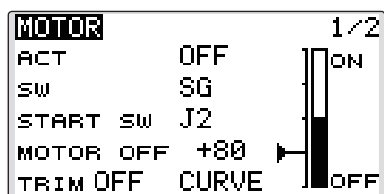

• Start switch function

When active, the "START SW" allows the motor's state to change from OFF to ON. The motor is ON when the main SW and "START SW" are turned ON simultaneously. The motor changes to OFF only when the main SW is turned off. If "START SW" is turned OFF but the main SW is still ON, the motor remains ON.

[START SW function example]

When the throttle (motor) stick is assigned as the "START SW", and the low throttle position of the throttle curve is adjusted, the motor starts operating with the initial stick movement. The motor will not cease functionality even if the stick position is returned to its lowest setting.

• Trim effect / invalid setting in motor OFF

If one of the trim levers is assigned to the Motor function, it is possible to turn the motor off with the trim lever. To maintain compatibility after updating the T12K, the trim setting is adjusted to the on position. However, it is suggested to return it to the off position accordingly in the programming of the transmitter.

*Data Reset will return the trim setting to the off position.

• Screen at the time of the motor OFF setting

When the MOTOR OFF setting is highlighted, you will note the presence of the small cursor that indicates the MOTOR OFF position. To adjust this MOTOR OFF position, use the throttle stick to move the cursor accordingly. When satisfied with this position, push and hold the RTN button on the transmitter.

*The larger cursor is used to indicate the output of the motor channel. This cursor reflects any throttle curves and motor mixing which may be active.

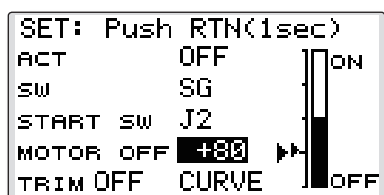

• Throttle curve button

When "CURVE" button is chosen, a throttle curve screen opens.

*When a throttle function is assigned to either channel, the "CURVE" button is not displayed because a throttle curve does not function as a motor curve.

This function is used when you want to mix elevator operation with rudder operation. It is used to correct undesirable tendencies when rudder is applied in rolling maneuvers such as knife edge flight.

- Mixing during flight can be turned ON/OFF by setting a switch. (Always ON at [--] setting)
- Link mixing can be set: Links this mix to other mixes.

- Select [RUD to ELE] at the Model menu and access the setup screen shown below by pushing the RTN button.

• Select the function name and return to the Model menu by pushing the RTN button or pushing the HOME/EXIT button.

<Push Dial>

- Scrolling
- Moving cursor
- Selecting mode
- Adjusting value
- To input data mode
- Data is entered

Setting method

• Activate the function

Move the cursor to the [ACT] item and push the RTN button to switch to the data input mode. Select the ACT mode by scrolling the Push dial.

*The display blinks.

Push the RTN button to activate the function and return to the cursor mode. (ON is displayed.)

When selecting a switch, move the cursor to the [SW] item and push the RTN button to call the selection screen. Select the switch and set its ON direction. (Always ON at "--" setting)

*For a description of the switch selection method, see the description at the back of this manual.

• 5-point curve setting (airplane)

[Curve rate setting]

1. Move the cursor to the curve rate setting item (left side) you want to adjust and push the RTN button to switch to the data input mode.

Adjust the rate by scrolling the Push dial.

Adjustment range: -100%~+100%

*When the RTN button is pushed for one second, the rate is reset to the initial value.)

Push the RTN button to end the adjustment and return to the cursor mode.

2. Repeat this procedure for each point.

[Moving curve point]

1. Move the cursor to the curve point setting item you want to adjust and push the RTN button to switch to the data input mode.

Adjust the curve point by scrolling the Push dial.

Adjustment range: Up to 2.5% in front of the adjoining point

*When the RTN button is pushed for one second, the curve position is reset to the initial value.)

Push the RTN button to end the adjustment and return to the cursor mode.

2. Repeat this procedure for each point.

[Deleting/returning curve point]

Move the cursor to the curve point setting item you want to delete/return and push the RTN button for one second.

• Link mode setting

When selecting the link mixing, move the cursor to the [LINK] item and push the RTN button to switch to the data input mode. Select the ON mode by scrolling the Push dial.

*The display blinks.

Push the RTN button to set the link mode and return to the cursor mode.

SNAP ROLL

[Corresponding model type]: Airplane, general

This function selects the switch and rate adjustment of ailerons, elevators, and rudder when a snap roll is performed.

- Four snap roll directions can be set. (Right/up, right/down, left/up, left/down)
- Operation mode: When [Master] mode is selected, the Snap Roll function is turned ON/OFF by the master switch. It is possible to set the direction switch to the direction in which you want to snap roll. When [Single] mode is selected, the snap roll in each direction can be executed by means of independent switches and positions.
- A safety switch can be set to prevent the accidental activation of the snap roll. For example, the landing gear is lowered, even if the switch is turned on accidentally the snap roll would not be executed. The snap roll switch is activated only when the safety switch is OFF.

(Example) Setting example for F3A

- Mode: [Master]
- Safety SW: [SG] (Safety measure)
- Master SW: [SH] (Main switch for executing snap roll)
- Direction switches:
 - *The snap roll up side left and right and down side left and right direction switches are selected here.
 - Right/Up: OFF [SD]
 - Right/Down: OFF [SD]
 - Left/Up: OFF [SA]
 - Left/Down: OFF [SA]

- Select [SNAP ROLL] at the Model menu and access the setup screen shown below by pushing the RTN button.

- Select the function name and return to the Model menu by pushing the RTN button or pushing the HOME/EXIT button.



SNAP ROLL		1/3		
	AIL	ELE	RUD	
→/↑	+100	+100	+100	
→/↓	+100	-100	-100	
←/↑	-100	+100	-100	
←/↓	-100	-100	+100	

<Push Dial>

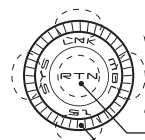

- Scrolling
- Moving cursor
 - Selecting mode
 - Adjusting value

- To input data mode
- Data is entered
- To next page

SNAP ROLL		2/3	
MODE	MASTER ←		
MASTER-SW	--		
SAFETY-SW	--		

- Master/single mode selection

SNAP ROLL		3/3	
	ACT	SW	
→/↑	OFF	--	
→/↓	OFF	--	
←/↑	OFF	--	
←/↓	OFF	--	

- Direction switches

Setting method

●Master/single mode selection

Move the cursor to the [MODE] item and push the RTN button to switch to the data input mode. Select the master or single mode by scrolling the Push dial.

*The display blinks.

[MASTER]: Master mode

[SINGLE]: Single mode

Push the RTN button to select the mode and return to the cursor mode.

When setting a master switch, move the cursor to the [MASTER-SW] item and push the RTN button to access the selection screen. Select the switch and set its ON direction.

*For a description of the switch selection method, see the description at the back of this manual.

When setting a safety switch, move the cursor to the [SAFETY-SW] item and push the RTN button to access the selection screen. Select the switch and set its ON direction.

●Direction switch selection

Move the cursor to the direction switch item and push the RTN button to access the selection screen. Select the switch and set its ON direction.

*For a description of the switch selection method, see the description at the back of this manual.

●Rate adjustment

Move the cursor to the aileron, elevator or rudder item for each direction and push the RTN button to switch to the data input mode. Adjust the rate independently by scrolling the Push dial.

Initial value: (Dependent upon the snap roll direction)

Adjustment range: -150~+150%

*When the RTN button is pushed for one second, the rate is reset to the initial value.)

Push the RTN button to end the adjustment and return to the cursor mode.

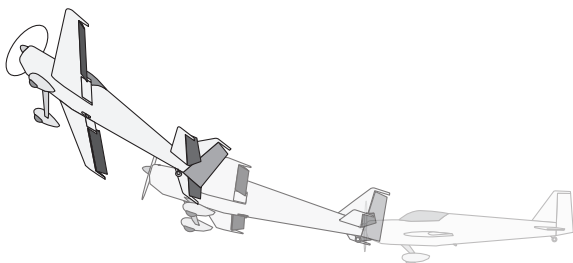

FLT. MODE

[Corresponding model type]: Multirotor

In the FLT. MODE (flight mode), you can change the multicopter mode to up to 3 CH, 5 signals set with any switch. It is used in the case of a multicopter controller of the type that can change the flight mode.

- Select [FLT. MODE] at the Model menu and access the setup screen shown below by pushing the RTN button.

Priority	FM	MODE	MODE2	MODE3	SW
Priority Low	FM1	-100	+0	+0	ON
	FM2	-50	+0	+0	SE
	FM3	+0	+0	+0	SE
	FM4	+50	+0	+0	SG
Priority High	FM5	+100	+0	+0	SG

Initial value: 0%
Adjustment range: -150% ~ 150%

• ACT/INH ON during operation

<Push Dial>

- Scrolling
- Moving cursor
- Selecting mode
- Adjusting value
- To input data mode
- Data is entered

• Set the flight mode selection switch. When FM2 to FM5 are all OFF, FM1 is selected.

• Switch selection

- Select [FUNCTION] at the Linkage menu and access the setup screen shown below by pushing the RTN button.

FUNCTION	2/3
CH: 5 MODE	←
CAMERA PAN	MODE 3
CAMERA REC	AUXILIARY6
MODE	AUXILIARY5
MODE 2	AUXILIARY4

• Assign MODE to the channel to be used for flight mode in advance.

Setting method

•Function setting

Assign the channel to be used with the function of the linkage menu(MODE/MODE2/MODE3).

•Rate adjustment

Move the cursor to the FM1-FM5/MODE-MODE3 item for each direction and push the RTN button to switch to the data input mode. Adjust the rate independently by scrolling the Push dial.

Initial value: 0%

Adjustment range: -150~+150%

*When the RTN button is pushed for one second, the rate is reset to the initial value.)

Push the RTN button to end the adjustment and return to the cursor mode.

•Switch selection

Move the cursor to the switch item and push the RTN button to access the selection screen. Select the switch and set its ON direction.

*For a description of the switch selection method, see the description at the back of this manual.

MODEL MENU (HELICOPTER)

This section contains information on helicopter-only commands. For instructions on Airplanes and Gliders, refer to the sections pertaining to those aircraft.

Use the Model Type function in the Linkage Menu to select the swash type matched to the respective aircraft.

Also, activate/deactivate flight conditions according to your model. To do so, access the

Condition Select screen prior to adjusting the model's parameters. (Up to five conditions can be used)

The Dual Rate function and other functions common to all model types have already been described elsewhere in this manual. Please refer to these respective sections for information on how to do so.

- Call the model menu shown below by long pushing the MDL button at the home screen, etc.

- Select the function name and return to the Model menu by pushing the RTN button or pushing the HOME/EXIT button.

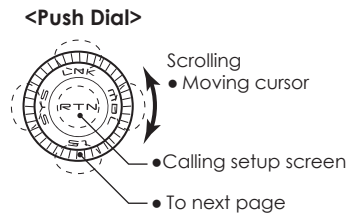
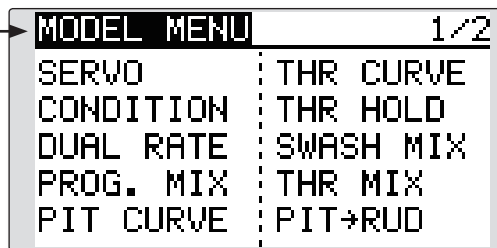

- Select the function you want to set and access the setup screen by pushing the RTN button.

Model Menu functions (helicopter) list

PIT CURVE: Adjusts pitch settings in different flight conditions.

THR CURVE: Throttle curve and hovering trim adjustment in different flight conditions.

THR HOLD: Moves the throttle to idle during auto-rotation.

SWASH MIX: Compensates control response in different flight conditions.

THROTTLE MIX: Compensates for power loss when cyclic is applied.

PIT to NEEDLE: Adjusts pitch response in different flight conditions.

PIT to RUD: Compensates torque changes from pitch angle inputs.

GYRO: Used to switch gyro sensitivity.

GOVERNOR: Used to switch RPM of the helicopter's head.

PIT CURVE/PIT TRIM

Pitch Curve

This function adjusts the pitch operation curve for each flight condition to optimize the model's performance in relationship to the throttle stick position.

*A simple curve can be created by reducing the number of input points to two or three, and then entering the specified value at the corresponding points.

- Select [PIT CURVE] at the Model menu and access the setup screen shown below by pushing the RTN button.

- Select the function name and return to the Model menu by pushing the RTN button or pushing the HOME/EXIT button.

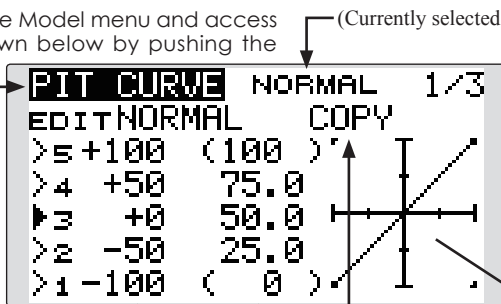

(Currently selected condition name)

<Push Dial>

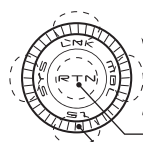

- Scrolling
- Moving cursor
- Selecting mode
- Adjusting value

- To input data mode
- Data is entered
- To next page

*The graph display includes the pitch trim operation.

Setting method

•5-point curve setting

[Curve rate setting]

1. Move the cursor to the curve rate setting item you want to adjust and push the RTN button to switch to the data input mode.

Adjust the rate by scrolling the Push dial.

Initial value: P1: -100%, P2: -50%, P3: 0%, P4: +50%, P5: +100%

Adjustment range: -100%~+100%

*When the RTN button is pushed for one second, the rate is reset to the initial value.

Push the RTN button to end the adjustment and return to the cursor mode.

2. Repeat this procedure for each point as desired.

[Moving curve point]

1. Move the cursor to the curve point setting item you want to adjust and push the RTN button to switch to the data input mode.

Adjust the curve point by scrolling the Push dial.

Initial value: P1: (0%), P2: 25%, P3: 50%, P4: 75%, P5: (100%)

Adjustment range: Up to 2.5% in front of the adjoining point

*When the RTN button is pushed for one second, the curve position is reset to the initial value.)

Push the RTN button to end the adjustment and return to the cursor mode.

2. Repeat this procedure for each point as desired.

[Deleting/returning curve point]

1. Move the cursor to the curve point setting item you want to delete/return and push the RTN button for one second.

•Pitch curve copy function

Move the cursor to COPY and push the RTN button to switch to the data input mode. Select the copy destination condition by scrolling the Push dial and push the RTN button. Select the [YES] and push the RTN button.

Normal curve adjustment

*For normal curve, create a basic pitch curve centered about hovering. Use this function together with the THR Curve (Normal) function and adjust the curve so that up/down control is best at a constant engine speed.

Idle up curve adjustment

*For the high side pitch curve, set the maximum pitch so that it does not overload the engine. For the low side pitch curve, create curves matched to loop, roll, 3D, and other purposes and use the idle up curves according to the performance.

Throttle hold curve adjustment

*The throttle hold curve is used when executing auto rotations.

Operation precautions

⚠ Warning

❗ When starting the engine and flying, always set the idle up condition switch to OFF and start the engine at idle.

Curve setting examples

The screens shown below are curves created by entering the pitch rate at low, center, and high side (3 points or 5 points) at each condition.

When creating a curve, input the rate specified by the model (or the reference value).

●Pitch Curve (Example)

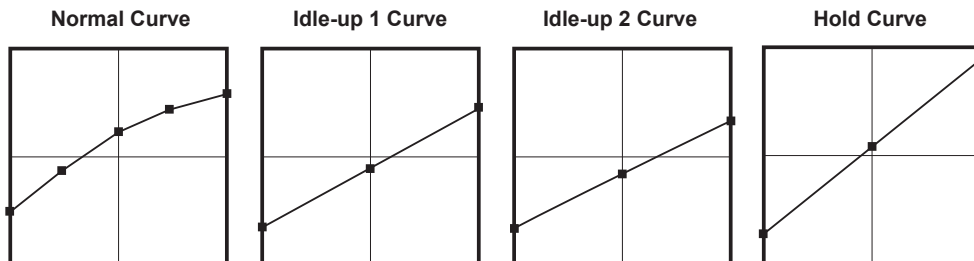

Pitch Trim (Hovering pitch, high pitch, low pitch)

[Hovering pitch trim setting]

PIT CURVE	NORMAL	2/3
HOVER	EDIT	NORMAL
ACT	ON	LD
MODE	CTRM	
RATE	+30%	(+0%)
RANGE	100%	

Hovering pitch trim

The Hovering Pitch trim function trims the pitch near the hovering point. Normally, it is used with the hovering condition. The hovering pitch can be fine tuned, for changes in rotor speed accompanying changes in temperature, humidity, and other flight conditions. Adjust the hovering pitch so that rotor speed is constant. This function can be used together with the Hovering Throttle Trim function for more precise operation.

Setting method

- Set the function to ACT [ON]. (initial setting)
- Select the adjustment knob.
Selection example: LD (initial setting)
- The trim operation mode (Mode: CTRM/ NORM) can be selected.
CTRM mode: Maximum amount of change near center by center trim operation (recommended)
NORM mode: Normal trim (parallel movement trim) operation. The advantage of using this mode is that the hovering pitch can be adjusted without changing the curve.
- The trim rate can be adjusted and the operation direction can be changed.
- Trim adjustment range (Range) setting
When this value is made small, trim can only be used near the center.

[Low/High pitch trim setting]

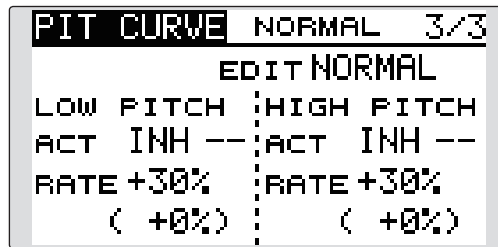

High Pitch/Low Pitch Trim

High Pitch/Low Pitch Trim is the pitch servo's high side and low side trim function.

Setting method

- Set the function to ACT (ON).
- Select the adjustment knobs.
Selection example: LS (high side), RS (low side)
- The trim rate can be adjusted and the operation direction can be changed.
- Trim acts as high side or low side trim with the center as the standard.

THR CURVE/THROTTLE HOVER TRIM

Throttle Curve

Throttle curve function adjusts the throttle operation curve for each condition to optimize the engine speed to throttle stick movement.

The Throttle Hover function trims the throttle near the hovering point. Normally, use it with hovering conditions. Changes in rotor speed

accompanying changes in the temperature, humidity, and other flight conditions can be trimmed. Adjust the throttle so that rotor rotation is most stable. More precise trimming is also possible by using this function along with the Hover Pitch function.

• Select [THR CURVE] at the Model menu and access the setup screen shown below by pushing the RTN button.

• Select the function name and return to the Model menu by pushing the RTN button or pushing the HOME/EXIT button.

(Currently selected condition name)

*The graph display includes the throttle hover trim operation.

THR CURVE NORMAL 1/3
EDIT NORMAL COPY

>5	100.0	(100)
>4	75.0	75.0
>3	50.0	50.0
>2	25.0	25.0
▶1	0.0	(0)

• curve rate • curve point • Throttle curve copy

<Push Dial>

- Scrolling
- Moving cursor
- Selecting mode
- Adjusting value
- To input data mode
- Data is entered
- To next page

Setting method

•5-point curve setting

[Curve rate setting]

1. Move the cursor to the curve rate setting item you want to adjust and push the RTN button to switch to the data input mode. Adjust the rate by scrolling the Push dial. Initial value: P1: 0%, P2: 25%, P3: 50%, P4: 75%, P5: 100%

Adjustment range: 0%~100%

*When the RTN button is pushed for one second, the rate is reset to the initial value.)

Push the RTN button to end the adjustment and return to the cursor mode.

2. Repeat this procedure for each point as desired.

[Moving curve point]

1. Move the cursor to the curve point setting item you want to adjust and push the RTN button to switch to the data input mode. Adjust the curve point by scrolling the Push dial. Initial value: P1: (0%), P2: 25%, P3: 50%, P4: 75%, P5: (100%)

Adjustment range: Up to 2.5% in front of the adjoining point

*When the RTN button is pushed for one second, the curve position is reset to the initial value.)

Push the RTN button to end the adjustment and return to the cursor mode.

2. Repeat this procedure for each point as desired.

[Deleting/returning curve point]

1. Move the cursor to the curve point setting item you want to delete/return and push the RTN button for one second.

•Throttle curve copy function

Move the COPY item and push the RTN button to switch to the data input mode. Select the copy destination condition by scrolling the Push dial and push the RTN button. Select the [YES] and push the RTN button.

Normal curve adjustment

*Normal curve creates a basic curve centered around hovering. Use it along with the normal pitch curve and adjust so that up/down control results in a constant engine speed.

Idle up curve adjustment

*Set a idle up curve that maintains a constant speed at all times, even during operation which reduces the pitch performed in flight. Create a curve matched to loop, roll, 3D, or other purposes and the idle up curve according to the performance.

Operation precautions

⚠ Warning

- When starting the engine and flying, always set the idle up condition switch to OFF and start the engine at idle.

Curve setting examples

The curves shown below are created by inputting the data of the 5 points for each condition, 0% (low side), 25%, 50% (center), 75%, 100% (high)

side. When creating a curve, enter the parameters specified per the model (or the reference value).

●Throttle Curve (Example)

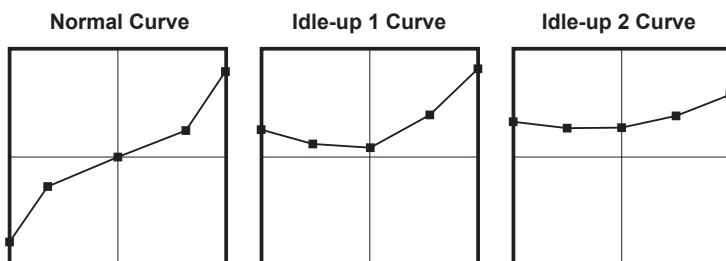

Throttle Hover trim

[Throttle hover trim setting]

```
THR CURVE NORMAL 2/3
HOVER EDIT NORMAL
ACT ON RD
MODE CTRM
RATE +30% (-1%)
RANGE 100%
```

Setting method

- Set the function to ACT ([ON]). (initial setting)
- Select the adjustment knob.
Selection example: RD (initial setting)
- The trim operation mode (Mode: CTRM/ NORM) can be selected.
CTRM mode: Maximum rate of change near center by center trim operation (recommended)
NORM mode: Normal trim (horizontal movement trim) operation.
- The trim rate can be adjusted and the operation direction can be set.
- Trim adjustment range (Range) setting
With smaller values, the trim is only active near the center.

Throttle limiter function

This function limits the high range of the throttle movement by any slider or trimmer.

*Control which adjusts the limit point during flight can be set.

[Throttle limiter setting]

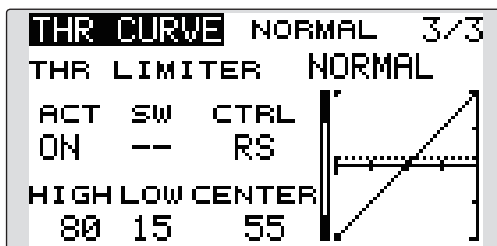

Setting method

*Set at the 3rd page of the throttle curve screen.

•Activate the function.

1. Select ACT and push the RTN button.
2. Switch the display to ACT by scrolling the Push dial.

*The display blinks.

INH: Inhibit

ACT: Activate

3. Enter the selection by pushing the RTN button.

•ON/OFF switch setting

1. Select SW and push the RTN button.
2. The H/W SET screen is displayed. Select the hardware and push the RTN button.

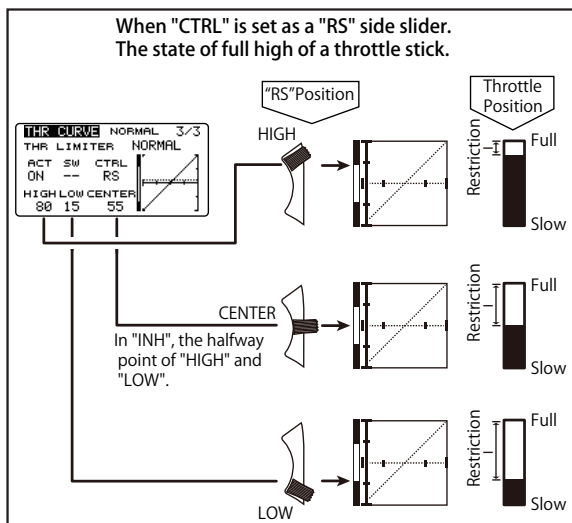

•High side operating range setting

1. Select HIGH and push the RTN button.
2. Adjust the high side operating range by scrolling the Push dial.

*A gauge is displayed at the left side of the graph.

3. Push the RTN button to switch to the cursor mode.

•Low side operating range setting

1. Select LOW and push the RTN button.
2. Adjust the low side operating range by scrolling the Push dial.

*A gauge is displayed at the left side of the graph.

3. Push the RTN button to switch to the cursor mode.

•Limiter operating range adjustment control setting

1. Select CTRL and push the RTN button.
2. The H/W SET screen is displayed. Select the hardware and push the RTN button.

*The throttle limiter operating position is indicated by a dotted line on the graph.

*When limiter operating range adjustment control is NULL, the throttle limiter function is not performed.

•Changing the control center position

1. Select CENTER and push the RTN button for 1 second. CENTER changes from INH to "rate display".
2. When the CENTER rate is changed, the neutral position of the hardware set at CTRL can be adjusted.

*When CENTER is INH, the neutral position becomes the LOW intermediate value.

*When CENTER is changed from INH to "rate display", the CENTER rate is set to the LOW intermediate value.

*The CENTER rate can be set between HIGH and LOW.

THR HOLD

This function sets the throttle cut position for auto rotation. The throttle servo operating speed can be adjusted. (Speed)

Note: Initially, this setting does not assign the throttle hold switch. Prior to adjusting the parameters for the throttle hold, we suggest designating a throttle hold switch. To do so, access the Condition menu within the Model menu options.

- Select [THR HOLD] at the Model menu and access the setup screen shown below by pushing the RTN button.

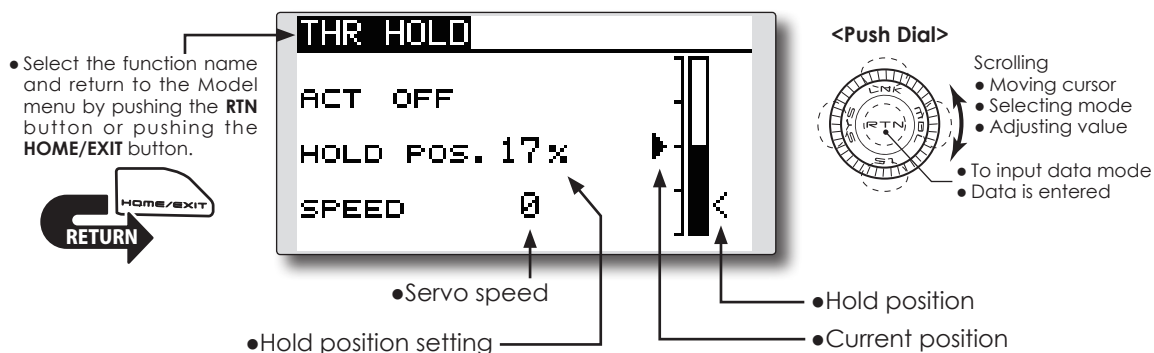

Setting method

• Hold condition switch selection

Use the Condition select menu of the Model menu to assign the hold condition switch. Selection example: SG

• Hold position adjustment

Move the cursor to the hold position item and push the RTN button to switch to the data input mode.

Adjust the rate by scrolling the Push dial.

Initial value: 17%

Adjustment range: 0%~50%

*Hold position sets the throttle cut position. Adjust it so that the carburetor is completely closed.

*When the RTN button is pushed for one second, the rate is reset to the initial value.)

Push the RTN button to end the adjustment and return to the cursor mode.

• Servo speed setting

Move the cursor to the servo speed item and push the RTN button to switch to the data input mode.

Adjust the rate by scrolling the Push dial.

Initial value: 0

Adjustment range: 0~27 (maximum delay)

*When the RTN button is pushed for one second, the rate is reset to the initial value.)

Push the RTN button to return to the cursor mode.

Operation precautions

⚠ Warning

- ⚠ When starting the engine and flying, always set the idle up condition switch to OFF and start the engine at idle.

SWASH MIX

The swash mix function is used to correct the swash plate in the aileron (roll) direction and elevator (cyclic pitch) corresponding to each operation of each condition.

This function allows the independent rate adjustments for the ailerons, elevator and pitch.

- Select [SWASH MIX] at the Model menu and access the setup screen shown below by pushing the RTN button.

Example of use

- As an example, use swash mixing to correct undesirable roll tendencies.
- For a condition which uses AIL to ELE, set this function to ON.

If the front of the helicopter raises during a right roll, when the Rate2 side is input and the right aileron is operated, the elevator moves to the down side. Tune by adjusting the Rate.

For left roll, adjust to the Rate1 side.

- Select the function name and return to the Model menu by pushing the RTN button or pushing the HOME/EXIT button.



(Currently selected condition name)

SWASH MIX	NORMAL	1/2
EDIT		
NORMAL	RATE1	RATE2
AIL→ELE	+0%	+0%
ELE→AIL	+0%	+0%
PIT→AIL	+0%	+0%
PIT→ELE	+0%	+0%

<Push Dial>

- Scrolling
- Moving cursor
- Selecting mode
- Adjusting value

- To input data mode
- Data is entered
- To next page

- Condition selection

SWASH MIX	2/2		
	ACT	SW	TRIM
AIL→ELE	INH	--	OFF
ELE→AIL	INH	--	OFF
PIT→AIL	INH	--	
PIT→ELE	INH	--	

Setting method

• Activate the mixing

When using this function, move the cursor to the [ACT] item and push the RTN button to switch to the data input mode.

Select the ACT mode by scrolling the Push dial.
*The display blinks.

Push the RTN button to activate the mixing and return to the cursor mode. (ON is displayed.)

[Switch selection]

When [[-]] is set, the swash mixing function is always active and operated by selecting the condition.

When setting an [ON]/[OFF] switch, move the cursor to the [SW] item and push the RTN button to access the selection screen. Set the switch and its ON position.

*For a description of the switch selection method, see the description at the back of this manual.

• Mixing rate adjustment

Move the cursor to the mixing rate item you want to correct and push the RTN button to switch to the data input mode. Adjust the rate independently by scrolling the Push dial.

Initial value: 0%

Adjustment range: -100~+100%

*When the RTN button is pushed for one second, the rate is reset to the initial value.

Push the RTN button to end the adjustment and return to the cursor mode.

• Trim mode ON/OFF setting

When changing the trim mode, move the cursor to the [TRIM] item and push the RTN button to switch to the data input mode.

Select ON/OFF by scrolling the Push dial.

*The display blinks.

Push the RTN button to change the trim mode ON/OFF and return to the cursor mode.

*When mixing includes master side trim, select [ON] and when mixing does not include master trim, select [OFF].

THROTTLE MIX

This function corrects the slowing of engine speed caused by swash plate operation during aileron or elevator operation. The method of applying clockwise or counterclockwise torque when pirouetting can also be corrected.

Setting example

- ALL to THR mixing counteracts the lag in the engine RPM's when aileron input is given to the helicopter. Engine over-speeding can be adjusted independently for the right aileron and left aileron inputs utilizing Rates1 and 2.

- Select [THROTTLE MIX] at the Model menu and access the setup screen shown below by pushing the RTN button.

- Select the function name and return to the Model menu by pushing the RTN button or pushing the HOME/EXIT button.

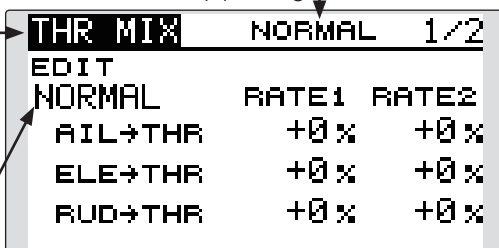

- Condition selection

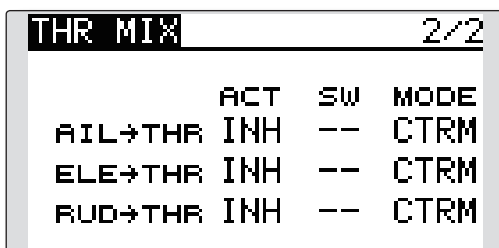
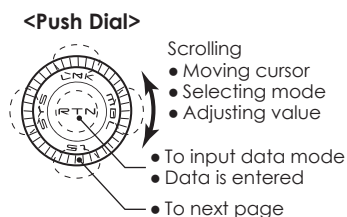

Setting method

•Activate the mixing

When using this function, move the cursor to the [ACT] item and push the RTN button to switch to the data input mode.

Select the ACT mode by scrolling the Push dial.

*The display blinks.

Push the RTN button to activate the mixing and return to the cursor mode. (ON is displayed.)

[Switch selection]

When [--] is set, the swash mixing function is always active and operated by merely selecting the condition.

When setting an [ON]/[OFF] switch, move the cursor to the [SW] item and push the RTN button to call the selection screen. Set the switch and its ON position.

*For a description of the switch selection method, see the description at the back of this manual.

•Mixing rate adjustment

Move the cursor to the mixing rate item you want to correct and push the RTN button to switch to the data input mode. Adjust the

rate independently by scrolling the Push dial. Initial value: 0%

Adjustment range: -100~+100%

*When the RTN button is pushed for one second, the rate is reset to the initial value.)

Push the RTN button to end the adjustment and return to the cursor mode.

•Operation mode setting

Move the cursor to the [MODE] item and push the RTN button to switch to the data input mode.

Select the operation mode by scrolling the Push dial.

*The display blinks.

CTRM mode: Corrects near the center only.

LIN. mode: Corrects the complete range.

Push the RTN button to change the operation mode and return to the cursor mode.

PIT to RUD mixing (Revolution mixing)

Use this mix when you want to suppress the torque generated by main rotor pitch and speed changes during pitch operation. Adjust so that the nose does not move in the rudder direction.

Note: When a GY Series or other heading hold gyro is used, since correction is performed by the gyro, this mix is not utilized. If this function is used when the gyro operation mode is the AVCS mode, the neutral position will change.

- Select [PIT to RUD] at the Model menu and access the setup screen shown below by pushing the RTN button. (Currently selected condition name)

- Select the function name and return to the Model menu by pushing the RTN button or pushing the HOME/EXIT button.

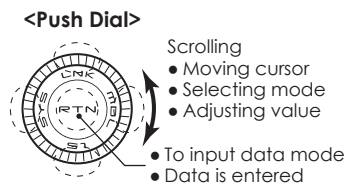
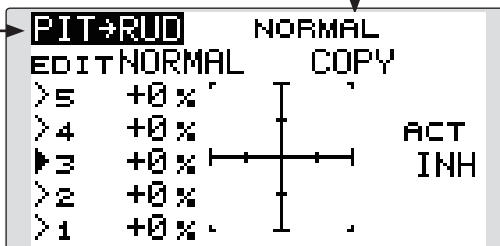

Setting method

• Activate the mixing

When using this function, move the cursor to the [ACT] item and push the RTN button to switch to the data input mode.

Select the ACT mode by scrolling the Push dial.

*The display blinks.

Push the RTN button to activate the mixing and return to the cursor mode. (ON is displayed.)

• 5-point curve setting

Move the cursor to the curve rate setting item you want to adjust and push the RTN button to switch to the data input mode.

Adjust the rate by scrolling the Push dial.

Initial value: P1~P5: 0%

Adjustment range: -100%~+100%

*When the RTN button is pushed for one second, the rate is reset to the initial value.)

Push the RTN button to end the adjustment and return to the cursor mode.

Repeat this procedure for each point.

• Pitch curve copy function

Move the cursor to COPY item and push the RTN button to switch to the data input mode. Select the copy destination condition by scrolling the Push dial and pushing the RTN button. Select the [YES] and push the RTN button.

<Normal condition mixing curve>

The mixing curve rate should be started using smaller values.

For a rotor with a clockwise operation direction, when pitch was input at the plus side, set these parameters so that mixing is in the clockwise direction. First, trim at hovering and then adjust the neutral position.

1. Adjustment between slow and hovering
Repeatedly hover from take off and land at a constant rate matched to your own rhythm. Adjust the pitch so that the nose of the helicopter remains steady when the throttle is raised and lowered.
2. Throttle high side (climbing and diving from hovering)

Repeat climbing and diving from hovering at a constant rate matched to your own rhythm and adjust the pitch so that the nose does not deflect when the throttle is raised and lowered.

<Idle up condition mixing curve>

Set the mixing rate so that the rudder direction at high-speed flight is straight ahead. Adjust for each condition used.

GYRO mixing

This function is used to adjust gyro sensitivity. The sensitivity and operation mode (Normal mode/AVCS mode) can be set for each condition.

The gyro sensitivity can be switched with each condition or the switch. (5 sensitivities)

*Compatible with 3 axis gyros (CGY750).

Note: When using the [Gyro2]/[Gyro3] function, assign [Gyro2]/[Gyro3] to any channel on the function screen.

Always set to [-] both (Control) and (Trim) for the [Gyro] function at the Function menu in the Linkage menu.

- Select [GYRO] at the Model menu and access the setup screen shown below by pushing the RTN button.

- Select the function name and return to the Model menu by pushing the RTN button or pushing the HOME/EXIT button.

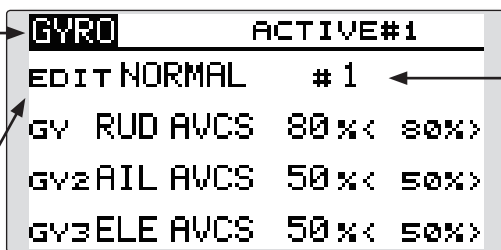

<Push Dial>

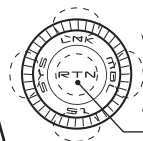

- Scrolling
- Moving cursor
- Selecting mode
- Adjusting value
- To input data mode
- Data is entered

- The edit conditions can be changed by pushing the S1 button.

*When the rate switching setting of all the gyros is "Switch", the edit conditions are not displayed.

- The edit rate can be changed by operating the edit rate button.

*When the rate switching setting of all the gyros is "COND", the edit rate button is not displayed.

- When the GYRO function button is selected, each GYRO detailed setting screen appears.

- Setup screen selection

- Condition/Switch selection

(Currently selected condition name)

- ON: (initial setting)

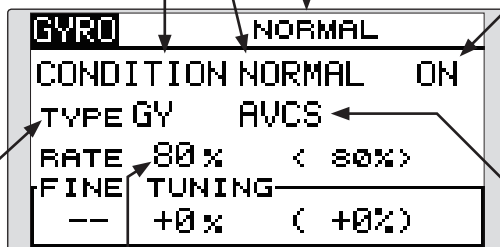

- Gyro type selection: [GY]/[NORM]

- Gyro sensitivity adjustment
- Fine tuning VR settings

- Mode selection: [AVCS]/[NORM]

Setting method

●Gyro type selection

Move the cursor to the gyro type selection item and push the RTN button to switch to the data input mode. Select the gyro type by scrolling the Push dial.

[GY]: When a Futaba GY gyro is used

[NORM]: When a non-Futaba GY gyro is used.

Push the RTN button to change the gyro type and return to the cursor mode.

*When a Futaba GY gyro is used and [GY] type is selected, the sensitivity set value is directly read in both the AVCS and NORM modes.

●Operation mode selection (GY gyro)

Move the cursor to the operation mode selection item and push the RTN button to switch to the data input mode. Select the operation mode by scrolling the Push dial.

[AVCS]: AVCS mode

[NORM]: Normal mode

Push the RTN button to change the operation mode and return to the cursor mode.

●Sensitivity setting

Move the cursor to the rate item and push the RTN button to switch to the data input mode.

Adjust the sensitivity by scrolling the Push dial.

Initial value: 80%

Adjustment range: 0~100%

*When the RTN button is pushed for one second, the sensitivity is reset to the initial value.)

Push the RTN button to return to the cursor mode.

●Fine tuning VR settings

Move the cursor to the [--] item and push the RTN button to access the selection screen. Select the control.

*For a description of the switch selection method, see the description at the back of this manual.

Move the cursor to the rate item and push the RTN button to switch to the data input mode.

Adjust the trim rate by scrolling the Push dial.

Initial value: 0%

Adjustment range: -20~+20%

*When the RTN button is pushed for one second, the sensitivity is reset to the initial value.)

Push the RTN button to return to the cursor mode.

<EXAMPLE>Rudder gyro gain is changed with a switch (SF) irrespective of condition.

Generally, gain is interlocked with condition and changes a rate.

How to change two rates in the same condition here.

1. Select [GYRO] at the Model menu and access the setup screen shown below by pushing the RTN button.

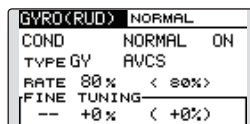

2. Move the cursor to the [COND] item and push the RTN button to access the selection screen. Select the [SW]. Push the RTN button to return to the cursor mode.

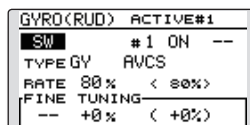

3. # number shows the present switch state. In the state of # 1 a cursor is moved to [--] and RTN is pushed.

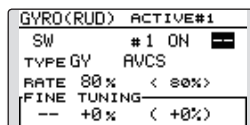

4. [SF] is chosen by [H/W SELECT] and then a top is turned ON.

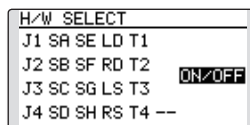

5. [TYPE GY] and [RATE] of a state of "#1=SF top" are set up.



● The number of a SW state

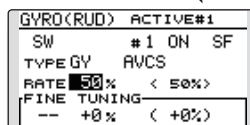

6. It is a setup of "#2". Move the cursor to the [#1] item and push the RTN button to access the selection screen. Select the [#2]. Push the RTN button to return to the cursor mode.

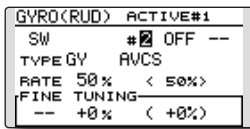

7. Move the cursor to the [--] item and push the RTN button.
8. [SF] is chosen by [H/W SELECT] and then a bottom is turned ON. the RTN button.
9. [TYPE GY] and [RATE] of a state of "#2=SF bottom" are set up.

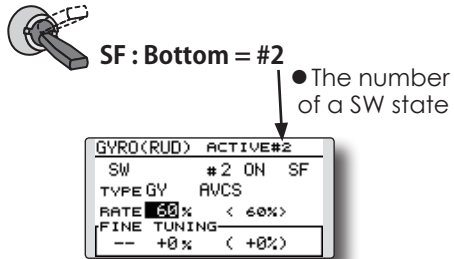

*If three position switch is chosen, the change of three rates can be performed.

*Combined use of two or more switches cannot be performed.

GOVERNOR mixing

When using a Futaba GV-1/GY701/CGY750 governor, this function is used to switch the RPM of the helicopter's rotor head. The rotor head speed can be switched with each condition or the switch.

*The governor is used by connecting the governor speed setting channel to CH7 (initial setting).

*When using an independent governor [ON]/[OFF] switch, connect the AUX([ON]/[OFF]) connector of the governor to CH8 and set the switch to CH8 (Governor2) at the Function menu of the Linkage Menu.

Note: Always set (Control) and (Trim) to [--] for [Governor] of the Function menu of the Linkage menu.

- Select [GOVERNOR] at the Model menu and access the setup screen shown below by pushing the RTN button.
- Setup screen selection
- Condition/Switch selection
- Select the function name and return to the Model menu by pushing the RTN button or pushing the HOME/EXIT button.
- Unit display selection: [%]/[rpm]

(Currently selected condition name)

- ACT/INH: INH (initial setting) <Push Dial>
- Scrolling
 - Moving cursor
 - Selecting mode
 - Adjusting value
- To input data mode
- Data is entered

• RPM adjustment

• Fine tuning VR settings

Setting method

•Activate the mixing

When using this function, move the cursor to the [INH] item and push the RTN button to switch to the data input mode.

Select the ACT mode by scrolling the Push dial.

*The display blinks.

Push the RTN button to activate the mixing and return to the cursor mode. (ON is displayed.)

When the Governor is changed from the default inhibited (INH) state to the active (ACT) state, the endpoint menu will be displayed and it is possible to utilize the endpoints for this given condition.

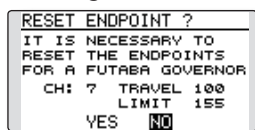

*When the function is set ON/OFF at the governor setup screen, the governor rpm setting channel end point servo travel and limit point are now initialized.

*When changed from INH to ACT (ON), the servo travel is initialized to 100 and the limit point is initialized to 155.

*When operation is changed to INH at all conditions, the servo travel is initialized to 100 and the limit point is initialized to 135.

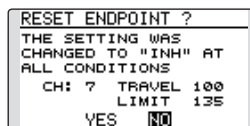

Use the Push Dial to scroll to either YES (incorporate the default endpoints) or NO (endpoints are not utilized). Push the Return (RTN) button to confirm the selection made.

•RPM adjustment

Move the cursor to the rate item and push the RTN button to switch to the data input mode.

Adjust the rpm by scrolling the Push dial.

Initial value: 50% (1500rpm)

Adjustment range: OFF, 0~110% (OFF, 700~3500rpm)

*When the RTN button is pushed for one second, the sensitivity is reset to the initial value.)

Push the RTN button to return to the cursor mode.

•Unit diplay selection

Move the cursor to the UNIT item and push the RTN button to switch to the data input mode. Select the unit by scrolling the Push dial.

Push the RTN button to change the operation mode and return to the cursor mode.

●Display mode selection

*When [rpm] mode is selected above setting, the display mode can be selected.

*There is no change in the transmitter output even when the "MODE" is changed. Calibration should be performed via the governor.

*In order to use the Governor function of the T12K, it is necessary to change the settings on the governor for the low side 700rpm mode.

When the MODE of the Governor screen's model menu is changed, the change is also indicated on-screen.



The chart below indicates the mode percentage and the corresponding RPM.

MODE	0%	50%	100%	110%
1000-2000rpm	1000rpm	1500rpm	2000rpm	2100rpm
1000-2500rpm	1000rpm	1500rpm	2500rpm	2700rpm
1000-3500rpm	1000rpm	1500rpm	3500rpm	3900rpm
700-2000rpm	700rpm	1500rpm	2000rpm	2100rpm
700-2500rpm	700rpm	1500rpm	2500rpm	2700rpm
700-3500rpm	700rpm	1500rpm	3500rpm	3900rpm

●Fine tuning VR settings

Move the cursor to the [--] item and push the RTN button to access the selection screen. Select the control.

*For a description of the switch selection method, see the description at the back of this manual.

Move the cursor to the rate item and push the RTN button to switch to the data input mode.

Adjust the trim rate by scrolling the Push dial.
Initial value: 0% (0rpm)

Adjustment range: -20~+20% (-200~+200rpm)

*When the RTN button is pushed for one second, the sensitivity is reset to the initial value.)

Push the RTN button to return to the cursor mode.

<EXAMPLE>RPM rate is changed with a switch (SF) irrespective of condition.

Generally, RPM rate is interlocked with a condition and changes a rate.

How to change two rates in the same condition.

1. Select [GOVERNOR] at the Model menu and access the setup screen shown below by pushing the RTN button.

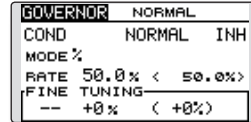

2. Move the cursor to the [COND] item and push the RTN button to access the selection screen. Select the [SW]. Push the RTN button to return to the cursor mode. And [INH] is set to [ACT].

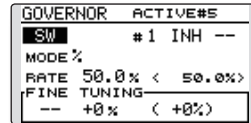

3. # number shows the present switch state. In the state of # 1, a cursor is moved to [--] and RTN is pushed.

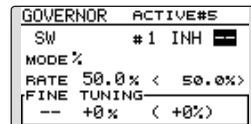

4. [SF] is chosen by [H/W SELECT] and then a top is turned ON.

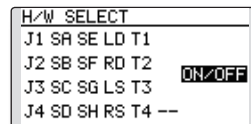

5. [MODE] and [RATE] of a state of "#1=SF top"are set up.



SF : Top = #1

● The number of a SW state

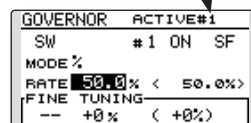

6. It is a setup of "#2". Move the cursor to the [#1] item and push the RTN button to access the selection screen. Select the [#2]. Push the RTN button to return to the cursor mode. And [INH] is set to [ACT].

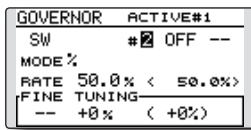

7. Move the cursor to the [--] item and push the RTN button.
8. [SF] is chosen by [H/W SELECT] and then a bottom is turned ON by pushing the RTN button.
9. [MODE] and [RATE] of a state of "#2=SF bottom" are set up.



SF : Bottom = #2

- The number of a SW state

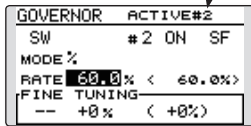

- *If the 3 position switch is chosen, 3 rate changes can be performed.
- *Combined use of two or more switches cannot be performed.

●CAL (Calibration)

This function transmits a reference signal from the transmitter for setting the governor's side speed display. The governor and transmitter set values (speed display) can be matched.

*The CAL button can only be displayed in rpm mode.

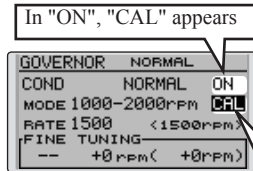

Button added to the reference signal output screen.
(Displayed only in the rpm mode.)

1. Move the cursor to the CAL button and push the RTN button.

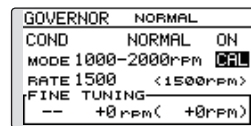

2. The display switches to the screen that transmits the reference signal.



3. Move the cursor to OFF and push the RTN button.

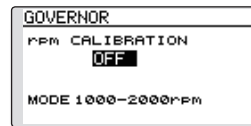

4. Once it scrolls to the mode of your choice, push the RTN button.

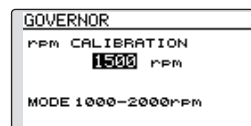

5. Set the transmitter's displayed speed. Adjust the governor's speed display on its side. (Refer to your governor's instruction manual on how to make proper adjustments).

TIMER ST1/ST2

Timer setting

The Timer function may be set for any desired time, i.e. engine run time, specified times for competitions, etc. Two independent timers are provided for your use. The timers are stored independently with each model, meaning that when you switch between model setups, the timer associated with the new model is brought up automatically.

The timers may be set to start and stop from the motion of any switch or stick. You may set the ON and OFF directions freely. Each timer has a capacity of up to 59 minutes 59, seconds.

Each timer may be set for countdown (DOWN mode) or count-up (UP mode) operation with a target time of up to 99 hours 59 minutes (HOUR mode).

If a target time is set and the timer reaches the set time, a buzzer sound for each count is generated.

Countdown timers sound one short beep during the last twenty seconds and two short beeps during the last ten seconds before reaching the target,

then a long tone at the target time, and continue counting while displaying a minus (-) sign. Count-up timers also beep the last twenty and ten seconds, beep the target time, and keep counting upwards until shutdown.

A mode which sounds an alarm each minute of the time remaining up to the timer alarm time can be selected.

The HOUR mode is convenient for engine maintenance and other long-term measurements.

*When the HOUR mode is set, "xx (hour): xx (minute)" is displayed on the count time display. Seconds are not displayed.

*When the HOUR mode is set, ":" blinks each second during timer operation.

*When the HOUR mode is set, the alarm function is inhibited.

- Select ST1 or ST2 at the home screen and call the setup screen shown below by pushing the RTN button.

• Select the function name and return to the home screen by pushing the RTN button or pushing the HOME/EXIT button.



TIMER

ST1, % 10:00.00 RESET

MODE DOWN TH% START SA

ALARM 10:00 STOP SB

MEMORY OFF RESET SC

Vibes OFF SPEECH INH



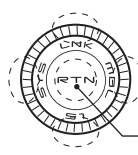

<Push Dial>



- Scrolling
- Moving cursor
- Selecting mode
- Adjusting value
- To input data mode
- Data is entered

"Vibes" type

If the following types are selected, the transmitter will vibrate during the warning.

TYPE 1		—————>
TYPE 2		————> ———>
TYPE 3		—> —> —> —>
TYPE 4		>>>>>>>>>>

Timer setting

●Up timer/down timer setting

Move the cursor to the [MODE] item and push the RTN button to switch to the data input mode.

Select the mode by scrolling the Push dial and push the RTN button.

[UP]: Up timer

[DOWN]: Down timer

[HOUR]: Hour mode timer

●Timer time setting

Move the cursor to the [ALARM] item and push the RTN button to switch to the data input mode.

Set the time by scrolling the Push dial.

[00]:[00]:[min]:[sec]

Push the RTN button to end the adjustment and return to the cursor mode.

●Switch setting

Move the cursor to the item of the switch you want to set, access the switch setup screen by pushing the RTN button. Select the switch and ON direction.

[For a detailed description of the setting method, see [Switch Setting Method] located on the next page.]

[START]: Start switch

[STOP]: Stop switch

[RESET]: Reset switch

●Memory setting

Move the cursor to the [MEMORY] item and push the RTN button to switch to the data input mode.

Select the mode by scrolling the Push dial and push the RTN button.

[OFF]: Memory function OFF

[ON]: Mode where the timer is not reset when turned power off and switched the model.

●A mode which sounds an alarm each minute can be selected.

Change the setting using the "↑" button (or "↓" button).

"↑": Alarm sounds each minute of the time elapsed from timer start. (Conventional mode)

"↓": Alarm sounds each minute of the time remaining up to the alarm time.

Timer operation

● Timer ST1 and ST2 are started/stopped by a pre-selected start/stop switch.

● To reset a timer, operate the pre-selected reset switch, or move the cursor to the [RESET] display on the timer screen and push the RTN button.

Speech function

Speech function is added to TIMER (ST1 and ST2). When the Up or Down timers are activated, speech output is available. It is phone output only.

■ ↑ mode

The voice outputs each minute of the time elapsed from timer start.

Ex. one minute, . . . two minutes, . . .

It outputs voice 20 seconds before reaching to the target time.

Ex. twenty seconds

It is counted down by voice from 10 seconds before reaching to the target time.

Ex. ten, nine, eight . . . three, two, one

■ ↓ mode

The voice outputs each minute of the time remaining up to the alarm time.

Ex. . . . ten minutes, . . . nine minutes, . . .

It outputs voice every 10 seconds from 50 seconds before reaching to the target time.

Ex. fifty seconds, . . . forty seconds, . . .

It is counted down by voice from 10 seconds before reaching to the target time.

Ex. ten, nine, eight . . . three, two, one

*The voice alarm of timer is delayed from the actual time.

*During logging telemetry data, the voice alarm is delayed.

*The priority of the timer speech is higher than the telemetry speech. Telemetry speech is stopped and the timer speech is outputted, even if telemetry speech is outputted.

*Usually, the priority of the speech of ST1 is higher than ST2. However, if the timer's 10-second countdown has already begun, it is given the priority.

*The telemetry speech cannot be outputted during the 10-second countdown.

TH% Timer

TH% Timer is the function which changes progress of a timer according to the location of the throttle stick. When the throttle stick is raised for faster speed, the speed of the timer usually increases. With the throttle stick at mid-range speed, the timer speed decreases (to 50%). When the throttle is positioned at low end, the timer's progress stops. It's possible to set the timer to match your fuselage's fuel consumption.

Buzzer

- Timers sound two short beeps during the last 10% before reaching the target.
- If a target time is set and the timer reaches the set time, a 1-second buzzer sounds.

Vibrator

- Vibrator is activated the last 10% before reaching the target.
- If a target time is set and the timer reaches the set time, vibrator is activated.

*The consumption of the battery/fuel is different depending on the conditions, so use an TH% Timer as reference.

*The TH% time is different from the actual elapsed time.

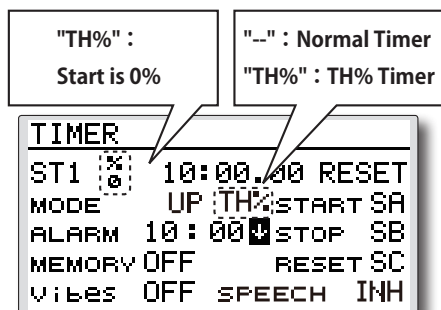

Up Timer Screen

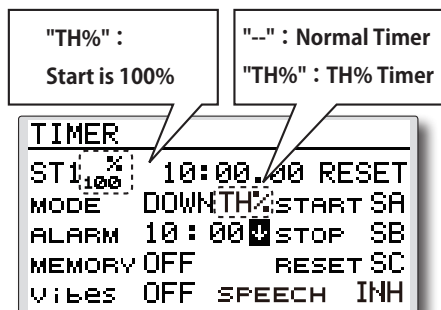

Down timer screen

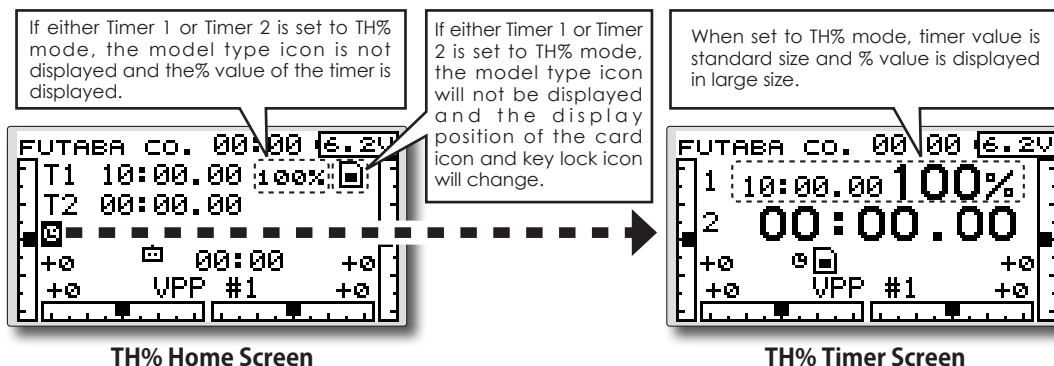

TH% Home Screen

TH% Timer Screen

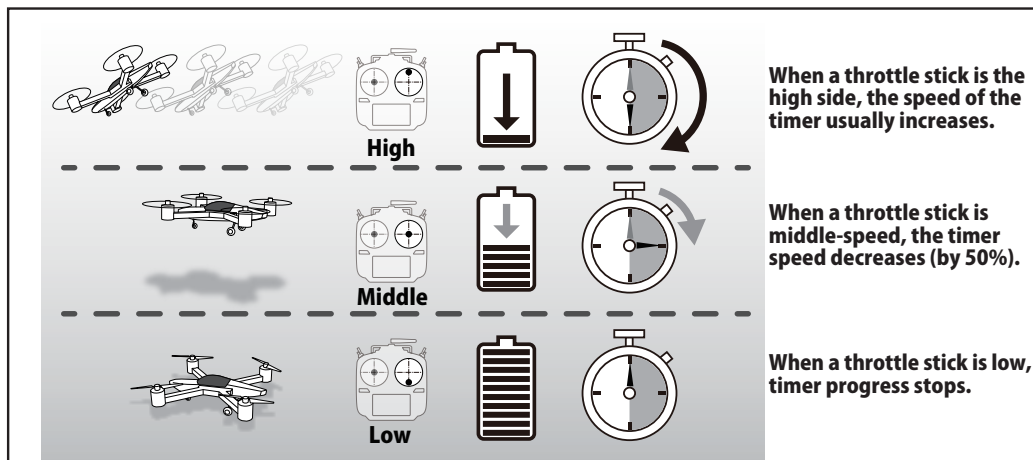

Switch Setting Method

The various functions used in the T12K can be activated by a switch. For the purposes of this manual, a stick position, VR position, etc. shall be commonly referred to as a switch in all cases.

Whenever the manual indicates that something is operated via a switch, it is possible for the user to activate this setting via a stick, stick position, etc.

Switch selection

When a switch is selected at a mixing function, etc., the selection screen shown below appears.

(Switch selection screen example)

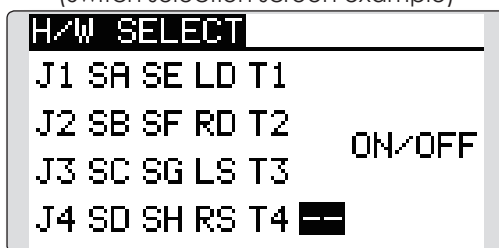

Switch selection

1. Use the Push dial to move the cursor (highlights) to the switch you want to select and push the RTN button.

*The switch blinks.

2. To return to the preceding screen, move the cursor to the [H/W SELECT] at the top of the screen and push the RTN button.

Or, move the cursor to the [ON/OFF] and call the ON/OFF position setting screen by pushing the RTN button.

When stick, trim lever, or knob selected

When a stick, trim lever, or knob is used as a switch, two operation modes can be selected:

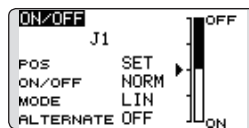

1. When you want to change the mode, move the cursor to [MODE] item and push the RTN button to switch to the data input mode. Switch the display to the mode you want to change by scrolling the Push dial and then make the change by pushing the RTN button.

●Mode: [LIN]/[SYM]

*Set the ON/Off point by the method described on the next page.

When the switch is selected

Once the switch is selected, the ON/OFF setting is also activated.

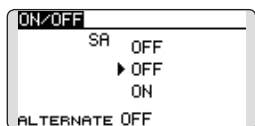

*The ON/OFF setting state of each position is displayed.

1. When you want to change the ON/OFF setting, use the Push dial to move the cursor and push the RTN button to switch to the data input mode. Switch the ON/Off display by scrolling the Push dial.

*ON/OFF display blinks.

2. When the RTN button is pushed, the ON/OFF setting is changed. (Push the S1 button to stop the change.)
3. To return to the preceding screen, move the cursor to the [ON/OFF] at the top of the screen and push the RTN button.

Alternate mode setting

●ALTERNATE mode: [OFF]/[ON]

1. Move the cursor to the [ALTERNATE] item and push the RTN button to switch to the data input mode.
2. Change to the mode you want to set by scrolling the Push dial.
*The mode display blinks.
3. Push the RTN button. (Push the S1 button to stop the change.)
4. To return to the preceding screen, move the cursor to the [ON/OFF] at the top of the screen and push the RTN button.

Operation modes

The operation modes available when a stick, trim lever, or knob is selected are described below.

Linear mode [LIN]

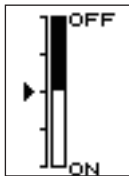

This mode sets ON/OFF to the left or right (up or down) with the set point as the reference.

Symmetrical mode [SYM]

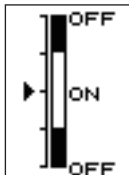

Left and right (up and down) operations are symmetrical near the neutral position. For instance, when you want to switch D/R with the aileron stick, when the stick is moved to the left or right, D/R can be turned on at the same position.

Shifting the ON/Off point

The ON/OFF point can be shifted. ON/OFF at a free position can be changed.

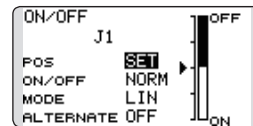

- Black range: OFF range
- White range: ON range

[Setting method]

1. First, use the Push dial to move the cursor to the [POS] item.
2. Move the stick, trim lever, or knob to the point you want to change and push the RTN button. The point is shifted.
3. To return to the preceding screen, move the cursor to the [ON/OFF] at the top of the screen and push the RTN button.

Logic switch (Condition Select function only)

The logic switch function lets you turn operation on or off by combining two switches.

Logic mode

AND: When both switches are ON, the condition is ON.

OR: When either switch is ON, the condition is ON.

EX-OR: When the two switches are in different states, the condition is ON.

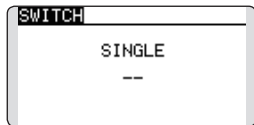

Switch mode selection

1. Move the cursor to the [SINGLE] item and push the RTN button to switch to the data input mode.
2. Select the [LOGIC] by scrolling the Push dial.
*[LOGIC] display blinks.
3. Push the RTN button to change to the logic switch mode.

(Logic switch setting screen)

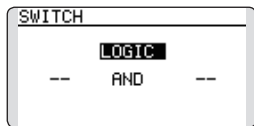

Logic mode selection

1. Move the cursor to the logic mode item and push the RTN button to switch to the data input mode.
2. Select the logic mode by scrolling the Push dial. [AND, OR or EX-OR]
*The mode display blinks.
3. Push the RTN button to change to the logic mode.

Swich selection

1. Select the right or left switch respectively.
(Refer to the description at the previous page.)

To return to the preceeding screen, move the cursor to the [SWITCH] at the top of the screen and push the RTN button.